

ARIA 3 SILENCE

Tangential air curtain with upper extraction with single electrical heating element

- cod. 12300050RI - cod. 12300051RI - cod. 12300055RI
- cod. 12300056RI



TECHNICAL SPECIFICATIONS:

- 8 models in white
- 3 speeds operated by remote control
- Air curtains are designed for indoor use
- Panel with coloured LEDs to indicate operating mode
- Automatic starter kit on request
- Upper air intake
- Electric heater operated by remote control
- The unit must be installed horizontally
- Nelle barriere d'aria con doppia resistenza possibilità di parzializzare il funzionamento delle resistenze elettriche

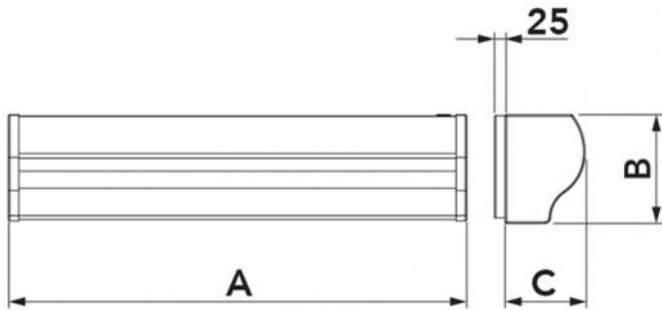

DIMENSIONS

CODE	A [mm]	B [mm]	C [mm]	SUITABLE FOR DOORS [mm]	WEIGHT [kg]
12300050RI	1085	250	185	L1000 H3000	14,8
12300051RI	1085	250	185	L1000 H3000	14,8
12300055RI	1440	250	185	L1500 H3000	21,4
12300056RI	2000	2040	250	L2000 H3000	28,6

TECHNICAL DATA

CODE	MODEL	SUPPLY VOLTAGE [V]	FREQUENCY [Hz]	POWER CONSUMPTION [W]	POWER ABSORBED WITH RESISTANCE [W]	AIR SPEED AT INLET [m/s]	AIR FLOW RATE [m³/h]	SOUND LEVEL [dB(A)]	ΔT AIR WITH HEATING ELEMENTS [°C]	REMOTE CONTROL
12300050RI	1100 right single fan	230 ac	50	75	1900	I:7.5 II:8 III:9	693 738 783	65 67 68	12	3 speed adjustment and resistance ON/OFF
12300051RI	1100 left single fan	230 ac	50	75	1900	I:7.5 II:8 III:9	693 738 783	65 67 68	12	3 speed adjustment and resistance ON/OFF
12300055RI	1500 central double fan	230 ac	50	190	3200	I:7.5 II:8 III:9	1161 1188 1215	68 68.5 69	12	3 speed adjustment and resistance ON/OFF
12300056RI	2000 central double fan	230 ac	50	190	3800	I:7.5 II:8 III:9	1332 1404 1458	67 68 70	12	3 speed adjustment and resistance ON/OFF

REMOTE CONTROL

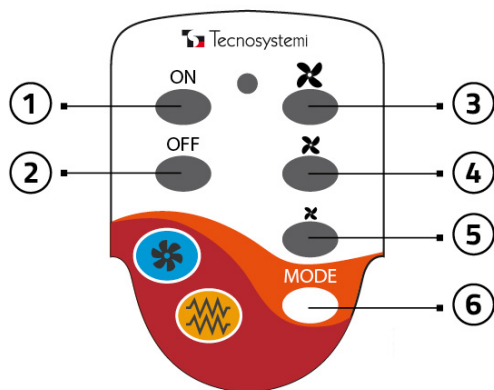

- [1] ON / Turns the appliance on
- [2] OFF / Shuts the appliance off
- [3] Maximum speed
- [4] Medium speed
- [5] Low speed
- [6] Selection of heating element

DASHBOARD LABEL

- [1] 1st speed (Min) 1 LED LIT
- [2] 2nd speed (Med) 2 LEDS LIT
- [3] 3rd speed (Max) 3 LEDS LIT
- [4] Heating element

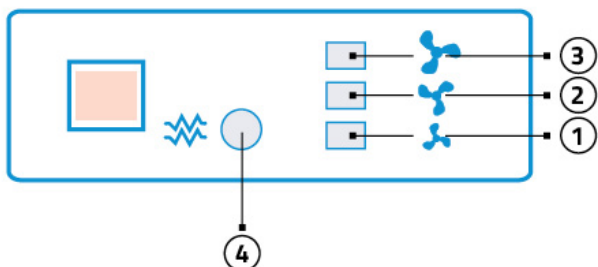

AUTOMATIC START KIT FOR AIR CURTAINS.

This kit, sold separately from the air curtain, allows you to switch the machine on and off by opening and closing the door.



SINGLE-PHASE POWER SUPPLY AND WIRING DIAGRAM

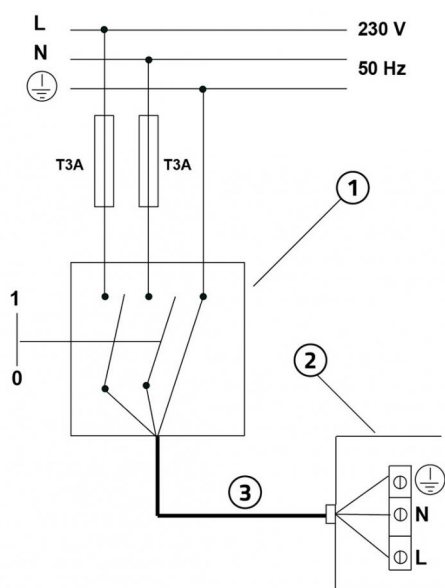

- [1] Omnipolar thermal magnetic protection switch compliant with EN 61508:1
- [2] Power cable 3x2.5 mm²
- [3] Electrical connection box

IMPORTANT!
During the electrical connection, the installer must comply with the polarities indicated by the plate in front of the power supply terminal board.

INSTALLING AND COMMISSIONING THE AUTOMATIC START KIT (optional)

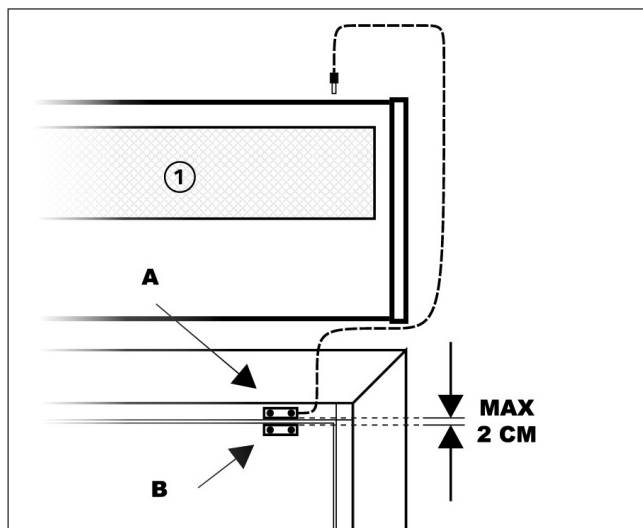

[1] Air curtain

Connect the wired sensor to the air curtain via jack.

Attach the magnetic sensor A to the door casing or to a solid point with the door frame.

Attach the second sensor to the moving part of the door leaving no more than 2 cm between the two sensors.

When the "automatic start kit" is installed, the air curtain can be switched on and off with the opening / closing of the door.

WALL-MOUNTED DRILLING SPACING MODEL 1100 RH/LH

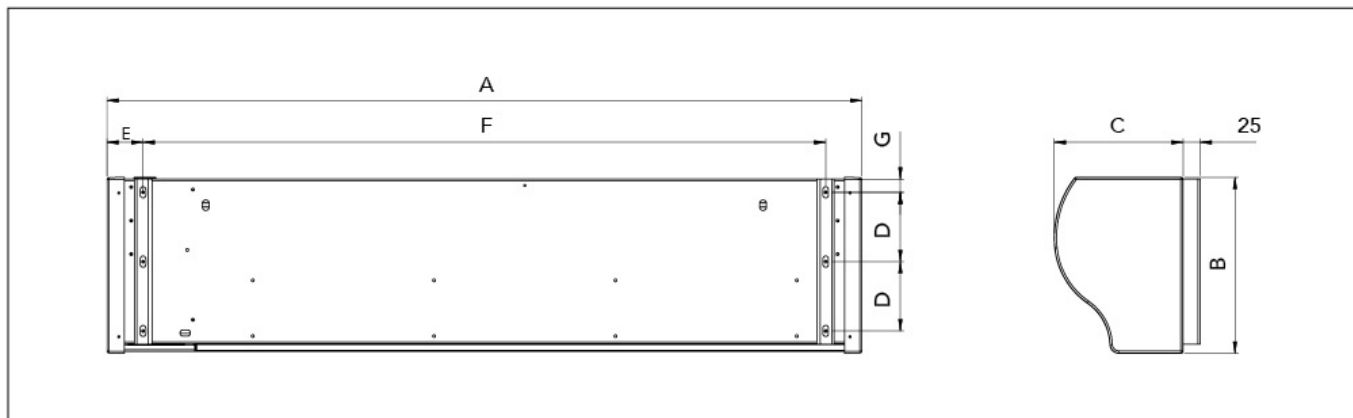

DIMENSIONAL TABLE

CODE	A [mm]	B [mm]	C [mm]	D [mm]	E [mm]	F [mm]	G [mm]
12300050RI	1085	250	185	99	52	980	20
12300051RI	1085	250	185	99	52	980	20

WALL-MOUNTED DRILLING SPACING MODEL 1500 CENTRAL

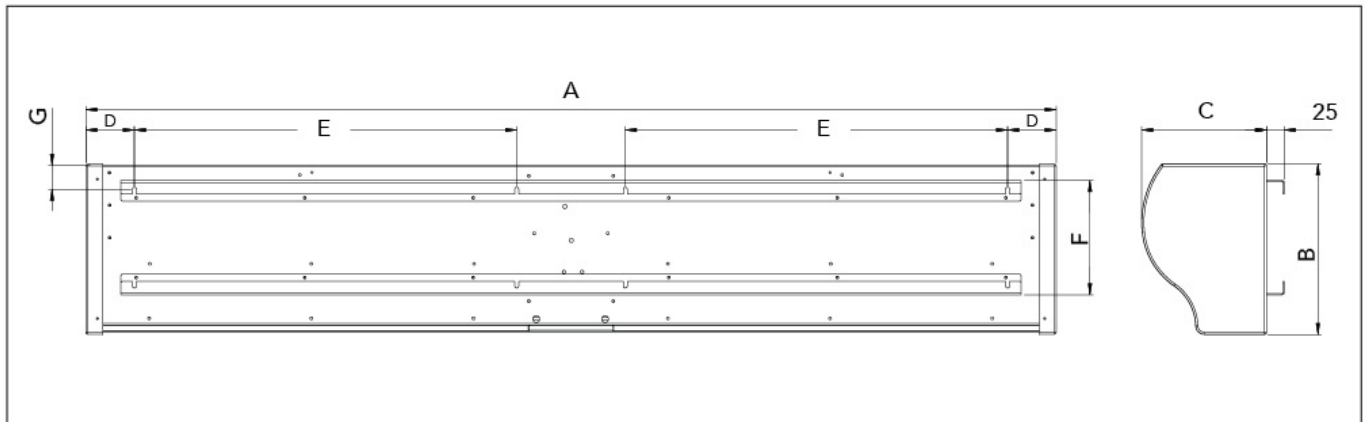

DIMENSIONAL TABLE

CODE	A [mm]	B [mm]	C [mm]	D [mm]	E [mm]	F [mm]	G [mm]
12300050RI	1440	250	185	72	566	170	35

WALL-MOUNTED DRILLING SPACING MODEL 2000 CENTRAL

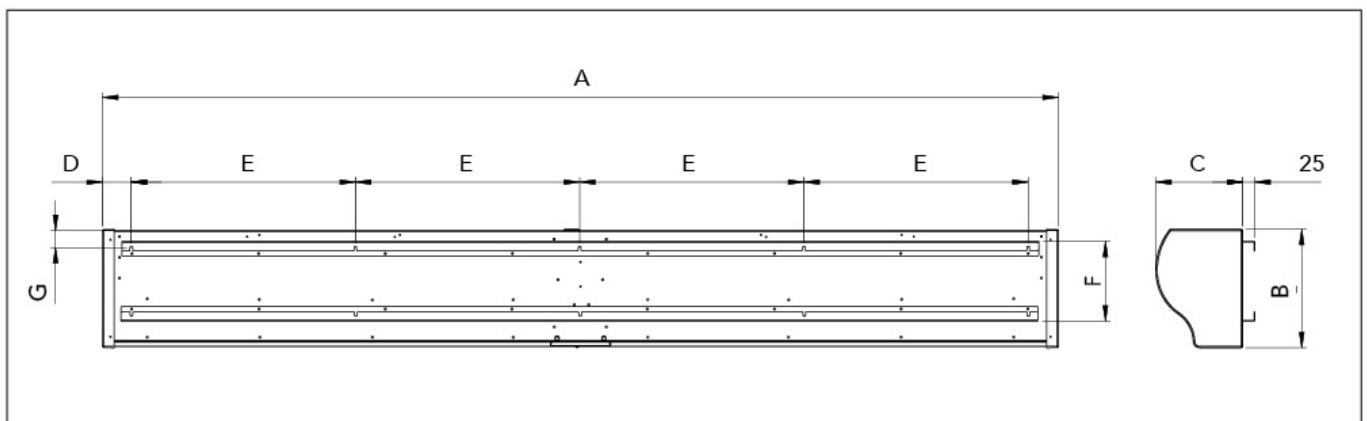

DIMENSIONAL TABLE

CODE	A [mm]	B [mm]	C [mm]	D [mm]	E [mm]	F [mm]	G [mm]
12300050RI	2040	250	185	67	478	170	35

ITEMS

CODE	DESCRIPTION
12300050RI	"ARIA3 SILENCE" SINGLE-FAN AIR CURTAINS WITH 1 RESISTANCE 1100 DX RESIST.
12300051RI	"ARIA3 SILENCE" SINGLE-FAN AIR CURTAINS WITH 1 RESISTANCE 1100 SX RESIST.
12300055RI	"ARIA3 SILENCE" DUAL-FAN AIR CURTAINS WITH 2 RESISTANCES 1500 GEN. RESIST.
12300056RI	"ARIA3 SILENCE" DUAL-FAN AIR CURTAINS WITH 2 RESISTANCES 2000 GEN. RESIST.

All rights relating to this publication are the exclusive property of Tecnosystemi SpA.
 Tecnosystemi SpA reserves the right to make changes at any time and without notice, for technical or commercial needs.