

# AIR PUR 3 PLUS WI-C

Cross-flow sensible heat recovery unit for recess 160 – 230 – 300

- cod. ACD200008 - cod. ACD200009 - cod. ACD200010



*AirPur3<sup>PLUS</sup>*  
wi-c

## DESCRIPTION

The Tecnosystemi static heat recovery system has been designed to ensure air exchange in the rooms where it is installed (small/medium-sized domestic and public rooms).

Equipped with two fans operating at the same time: one for expelling the stale air present inside the room, the other for the introduction of fresh air from the outside.

The unit is equipped with two lattice filters on the internal grille for the filtering of both delivery and exhaust air.

In the heat recovery unit there is a plastic heat exchanger pack, removable and washable, that retains the heat from the expelled air to transfer it to the fresh inlet air, thus allowing a strong reduction in thermal dispersion and consequent economic savings with respect to the exchange of air by opening the windows.

The heat recovery unit is designed for continuous operation, always connected to the power source.

Easily controlled with Smartphone and Tablet and remote control supplied)

DIMENSIONS

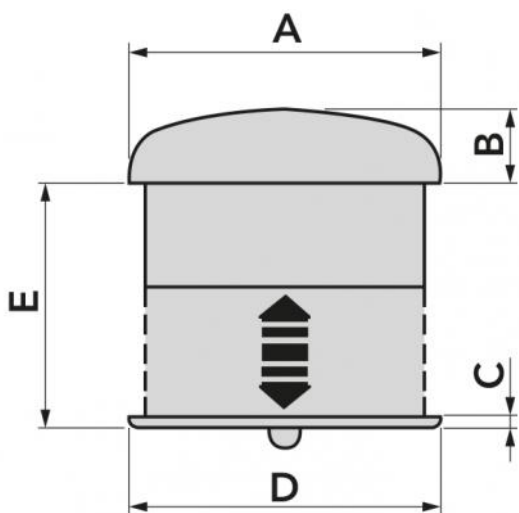
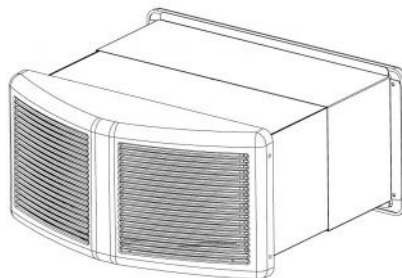
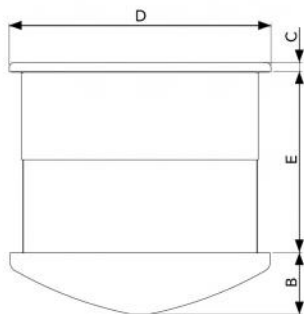
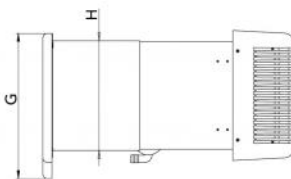
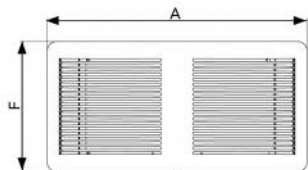

CODE	A [mm]	B [mm]	C [mm]	D [mm]	E [mm]	F [mm]	G [mm]	H [mm]	I [mm]
ACD200008	532	125	19	536	200/400	220	265	292	220
ACD200009	532	125	19	536	200/400	220	265	292	220
ACD200010	532	125	19	536	200/400	220	265	292	220

## AIR PUR 3 PLUS WI-C

MODEL	160 WI-C	230 WI-C	300 WI-C
Power supply [V]	230		230 230
Frequency [Hz]	50		
Max power [W]	30	35	70
Protection rating [IP]	20	20	20
% Exchange efficiency (min.1)	76	72	67
% Exchange efficiency (min.2)	74	70	64
% Exchange efficiency (max.3)	73	68	60
Air flow rate [m³/h] (min. 1)	70	92	150
Air flow rate [m³/h] (med. 2)	120	166	264
Air flow rate [m³/h] (max. 3)	161	230	300
Sound level [dB(A)] (min)	36	36	40
Sound level [dB(A)] (med)	44	45	51
Sound level [dB(A)] (max)	48	49	53
Weight [kg]	18	19	
Wall hole [mm]	230 x 490	230 x 490	230 x 490

## OPERATING MODE

### WI-FI MODE

All Pico functions can also be controlled via WI-FI directly from smartphones or tablets in a simple and intuitive way.

### COMFORT MODE

The system activates taking advantage of the temperature difference between the external and internal environments, in order to reach an ideal temperature in the internal environment.

## USING THE REMOTE CONTROL

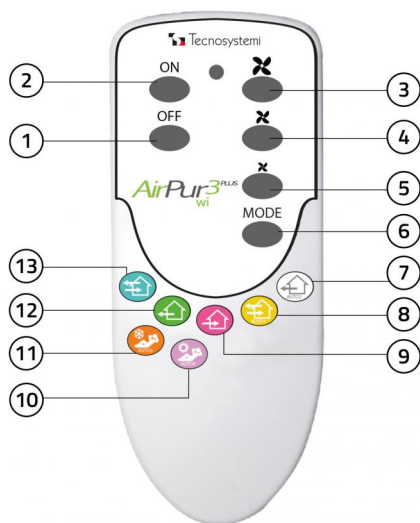

- [1] Fan OFF
- [2] Fan ON
- [3] Maximum speed (humidity value 60%)
- [4] Medium speed (humidity value 50%)
- [5] Low speed (humidity value 40%)
- [6] Change mode
- [7] AUTO 2
- [8] AUTO 1
- [9] Delivery
- [10] AUTO 4 Winter comfort mode
- [11] AUTO 3 Summer comfort mode
- [12] Extraction
- [13] Air recovery unit

## FUNCTIONS OF THE REMOTE CONTROL

**HEAT RECOVERY UNIT:** the system operates simultaneously in both extraction and intake with the possibility of adjusting the three speeds.

**EXTRACTION:** the system works in internal air extraction only mode, with the possibility to regulate the three speeds.

**DELIVERY:** the device works in aeration only mode, aspirating external air and introducing it into the room, the possibility of regulating the three speeds is provided.

**AUTO 1:** the system is in standby, when the air in the room exceeds the threshold of humidity; settable at 40%, 50% or 60%, the device starts in recovery mode until the humidity level falls within the set value.

**AUTO 2:** the system is in standby, when the air in the room exceeds the threshold of humidity; settable at 40%, 50% or 60%, the device starts in extraction only mode until the humidity level falls within the set value.

**AUTO 3 - SUMMER COMFORT:** the system is in stand-by mode, if the outdoor temperature is lower than the indoor temperature, the heat recovery unit will go into delivery mode at maximum speed; the machine will return to standby when the temperature value is restored.

**AUTO 4 - WINTER COMFORT:** the system is in stand-by mode, if the outdoor temperature is higher than the indoor temperature, the heat recovery unit will go into delivery mode at maximum speed; the machine will return to standby when the temperature value is restored.

## INSTALLATION

To install the built-in heat recovery units, it is necessary to provide a rectangular hole on the masonry with a minimum size of 490 mm wide x 230 mm high to allow the insertion of the metal body, and a further drain hole to allow the passage of the condensation water pipe.

## WIRING DIAGRAM

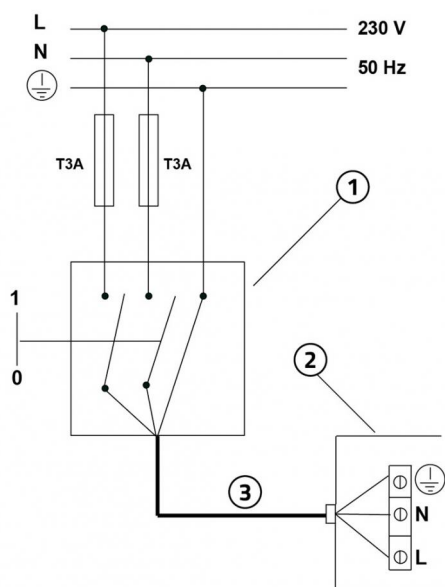

- [1] Omnipolar thermal magnetic protection switch compliant with EN 61508:1
- [2] Power cable 3x2.5 mm<sup>2</sup>
- [3] Electrical connection box

### IMPORTANT!

During the electrical connection, the installer must comply with the polarities indicated by the plate in front of the power supply terminal board.

**ITEMS**

CODE	DESCRIPTION
ACD200008	"COMFORT-AIR PUR 3 PLUS WI-C" BUILT-IN STATIC HEAT RECOVERY UNIT, MOD.160
ACD200009	"COMFORT-AIR PUR 3 PLUS WI-C" BUILT-IN STATIC HEAT RECOVERY UNIT, MOD.230
ACD200010	"COMFORT-AIR PUR 3 PLUS WI-C" BUILT-IN STATIC HEAT RECOVERY UNIT, MOD.300

All rights relating to this publication are the exclusive property of Tecnosystemi SpA.  
Tecnosystemi SpA reserves the right to make changes at any time and without notice, for technical or commercial needs.