

Apply Air

Air Curtains and Accessories

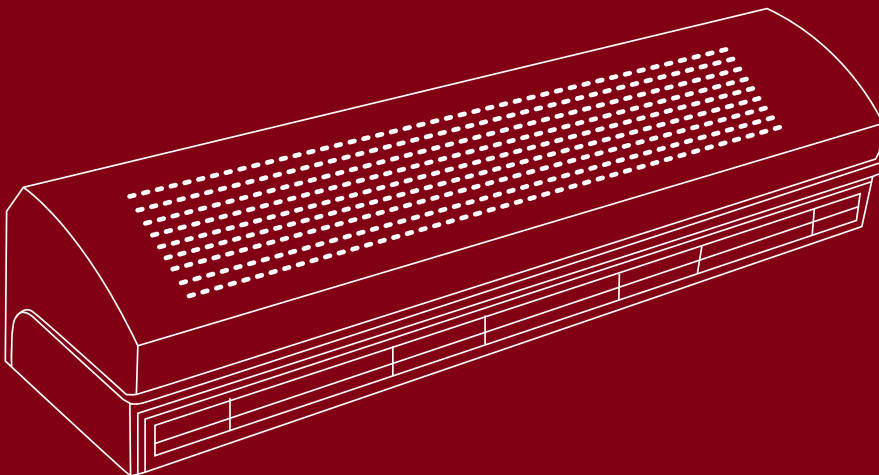
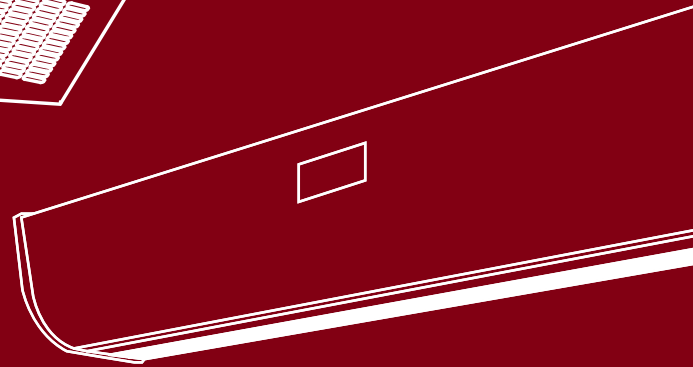
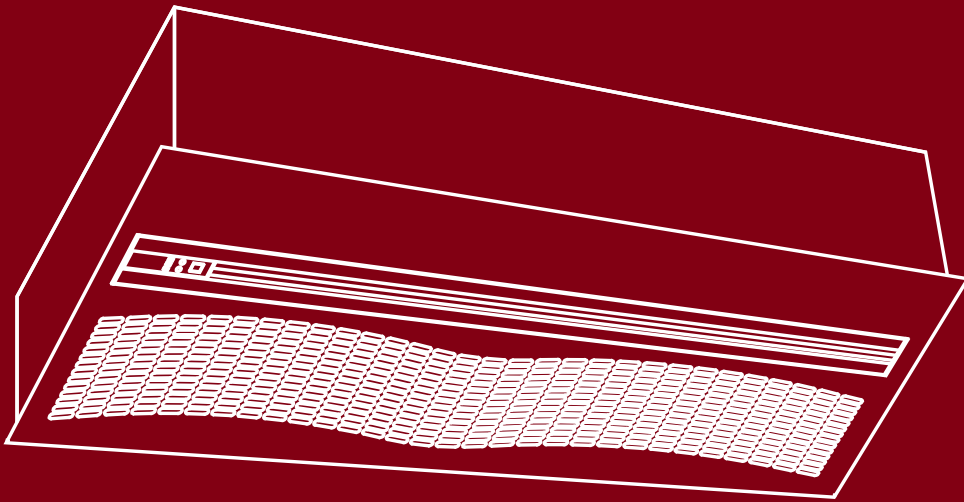

Research of design, attention to details, high performance and attention to consumption are the elements that characterise the offer of **air curtains available in over 50 residential and industrial models**: at room temperature, with electric heating elements or with hot water coil, as well as a wide range of accessories. A range created with the aim of improving well-being, reducing consumption and protecting the environment.

PRODUCT INDEX

15

Tangential air curtain with upper extraction "ARIA 3 SILENCE"



17

Tangential air curtain with upper extraction with single or double electric heating elements "ARIA 3 SILENCE"



20

Tangential air curtain with front extraction "ARIA 3 SILENCE FRONT"



22

Tangential air curtain with PTC heating element with upper extraction "ARIA 4 INNOVATION" single-phase and three-phase



25

Built-in tangential air curtains at ambient temperature "ARIA 2 ELEGANCE T"

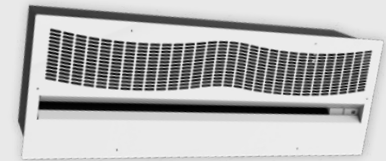

26

Built-in tangential air curtain with electric heating element "ARIA 2 ELEGANCE TR"

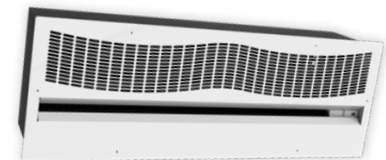

29

Centrifugal air curtain with upper extraction with built-in led bar light "AIRJET"



32

Centrifugal air curtain with upper extraction "AIR FOR 3 UP"



33

Air curtain with body in centrifugal "ABS" with upper extraction "AIR FOR 3 STYLE"



34

Centrifugal air curtain with front extraction "AIR FOR 3 FRONT"

AT ROOM TEMPERATURE



35

Centrifugal air curtain with upper extraction "AIR FOR 3 WALL"

AT ROOM TEMPERATURE



36

Built-in centrifugal air curtain with electric heating element with front air intake "AIR FOR 3 CR"

ELETRIC HEATING ELEMENT

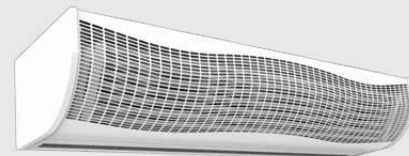

37

Centrifugal air curtain with front extraction hot water coil "AIR FOR 3 H2O"

HOT WATER COIL



39

Built-in centrifugal air curtain at ambient temperature "ARIA 2 ELEGANCE"

AT ROOM TEMPERATURE

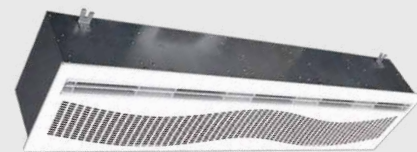

40

Built-in centrifugal air curtain with electric "ARIA 2 ELEGANCE CR"

ELETRIC HEATING ELEMENT



41

Built-in centrifugal air curtain with hot water coil "ARIA 2 ELEGANCE H2O"

HOT WATER COIL

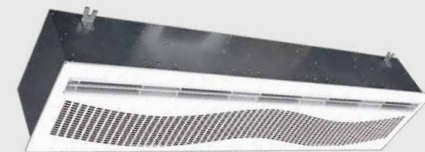

42

Large flow industrial centrifugal air curtains with front air intake "ARIA 1 POTENZA"

AT ROOM TEMPERATURE



43

Spare parts for air curtains





WHY TO INSTALL AN AIR CURTAIN?

Air curtains allow to keep the doors opened, encouraging people to enter inside stores and enable customers to move around with ease, offering maximum freedom of movement and visibility by maintaining an ideal degree of comfort inside the premises.

**Moreover, we guarantee an immediate reduction in heat loss of up to 80%.
Your air-conditioning system will work better and consume less energy!**

IT'S THE IDEAL CHOICE FOR:



Hospitals and laboratories



Catering, reception facilities, offices



Warehouses and manufacturing units



The food industry, where a separation between different areas is called for in terms of temperature and hygiene, and at the same time the quick, easy transit of goods and people is necessary



Bars, restaurants, ice-cream parlours



Cold storage facilities (external installation)



Shops in general

All commercial undertakings with free access is an invitation to customers to enter

CONFIGURE YOUR AIR CURTAIN



On the website [tecnosystemi.com](https://www.tecnosystemi.com)



Automatically generate **quotes** and **technical data sheet** for the chosen products



BIM TECHNOLOGY

Tecnosystemi provides professionals in the mechanical, architectural and structural design sector with all models of air curtains in 3D data to be used in **BIM** (Building Information Modeling).

Technical data of our air curtains can be downloaded for free on the **BIMOBJECT** platform.

THE AIR CURTAINS GUARANTEE

1

Simple rapid installation, extremely low energy consumption

2

Energy saving heating, maintenance-free

3

A factory-calibrated air flow

4

Heating function heats the air flow in order to optimize energy saving in cold weather

*

5

Once installed maintains a perfectly balanced flow thanks to its patented aerodynamic shape

6

3 speeds to regulate air flow according to your needs, by means of an easy to use remote control advice

8

Thanks to its compact size and modular composition perfectly fits into any kind of room

7

The system switches on/off automatically when the door opens/closes



The air curtains guarantee a reduction in energy consumption

* Only for models with electric resistance and hot water coil

REJECTS

Summer Heat 

Pollution 

Bad Smells 

Noise 

Winter Cold 

Dust 



HOLDS

→ Hot air

→ Cold air

→ Clean air





COMPARISON OF TEMPERATURE DISTRIBUTION

SUMMER

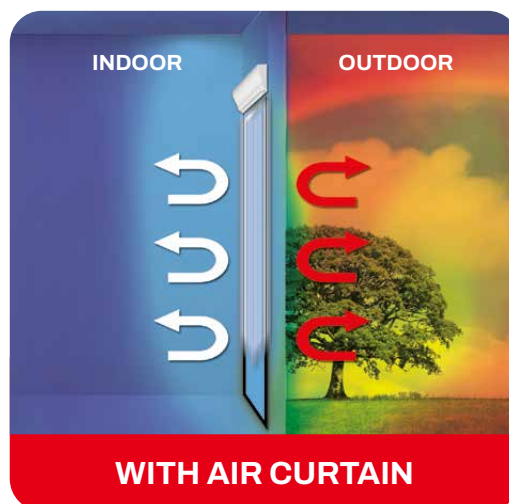
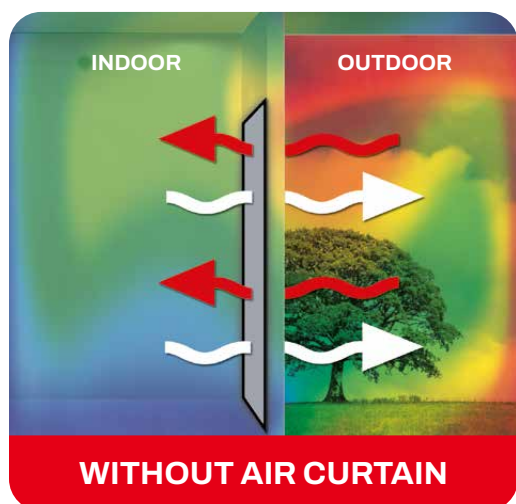

WINTER

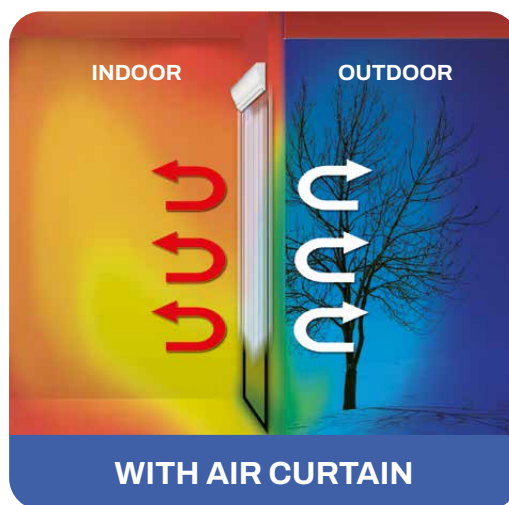
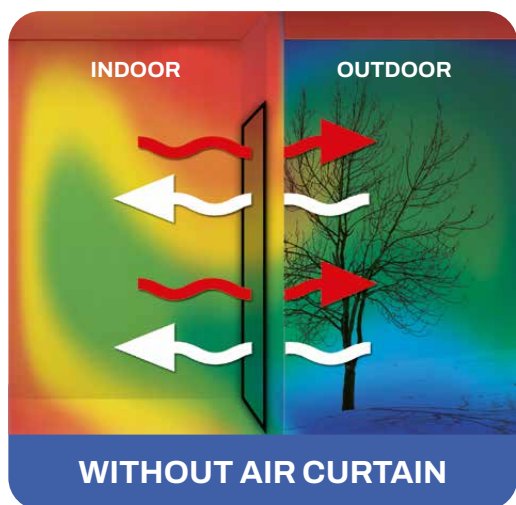

TEMPERATURE CHART





GUIDE TO CHOOSE THE RIGHT AIR CURTAIN MODELS

QUESTIONS TO ASK BEFORE BUYING

- Where will the air curtain be mounted? (shop, bar, restaurant, office, shopping center, etc.)
- Do you need the air curtain to be in-built or wall mounted?
- Do you want it with tangential or centrifugal motors?
- Have you considered whether you want it with front or top air intake?
- Do you prefer the air to be at room temperature, heated with electrical resistance, or heated with battery?
- Do you need an automatic start on door opening? (not with electrical resistance)

Note: the “automatic start” kit block the functioning of all the air curtains with heating elements.

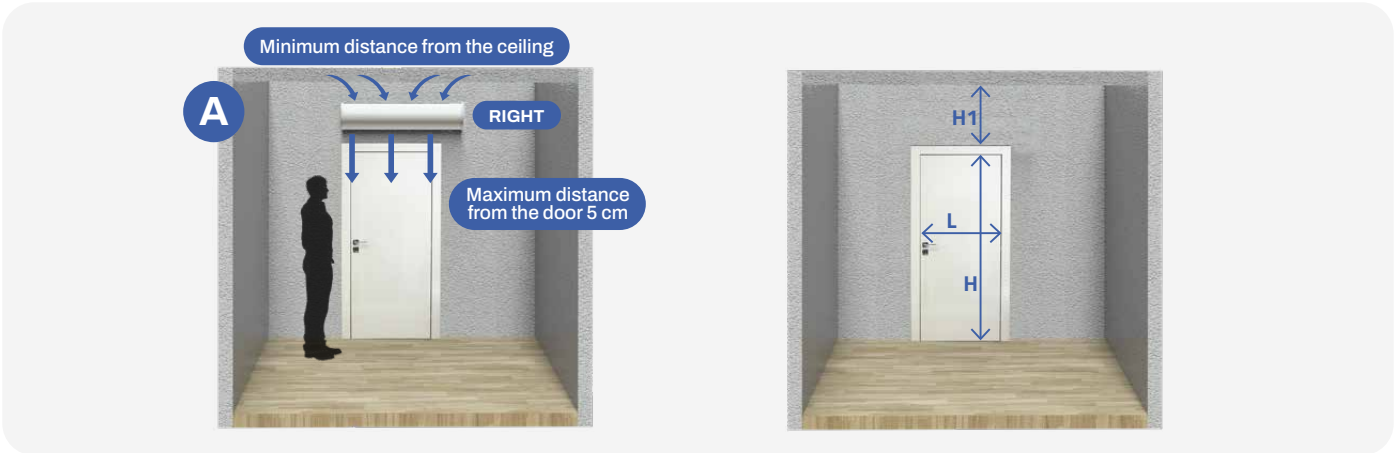

INFORMATION GATHERING: CHOICE OF THE AIR CURTAIN WITH LEFT, CENTRAL OR RIGHT WALL MOTOR

The choice of the air curtain with left, right or cen (central) motor, refers to the motor position in the air curtain (which must correspond to the door opening).

The reference is considered in frontal position with respect to the air curtain (opposite).



CORRECT INSTALLATION OF AIR CURTAINS WITH FRONT AIR INTAKE RESPECTING THE DESCRIBED MEASUREMENTS



For both cases, we always recommend consulting the technical specifications of the catalogue and the instructions supplied or downloadable from the site www.tecnosystemi.com

! Very important:

A) To assemble the air curtains with top air intake, the distance between the curtains and ceiling must be minimum 15 cm, to allow the air suction through the upper grid.

The distance between the air curtain and the door must be of maximum 5 cm except Aria3 Silence Front air curtain (see at pag. 20).

B) To assemble the air curtains with front air intake, the space above the unit and the ceiling is not considered, because the air suction comes from the front grid of the curtain.

The distance between the air curtain and the door must be maximum 25 cm.

C) Air curtains with a central motor of 2 m - 1.5 m, and those with centrifugal motors, must always follow the instructions of (a) and (b) however they can be always be installed in the centre of the door.

AIR CURTAINS WITH ASSEMBLY OF TYPE A	AIR CURTAINS WITH ASSEMBLY OF TYPE B
AIR CURTAINS WITH TOP AIR INTAKE	AIR CURTAINS WITH FRONT AIR INTAKE
ARIA 3 SILENCE at room temperature	ARIA 3 SILENCE-FRONT at room temperature
ARIA 3 SILENCE at room temperature	AIRFOR 3 FRONT at room temperature
AIRFOR 3 UP at room temperature	AIRFOR3 H2O with hot water coil
AIRFOR 3 STYLE at room temperature	AIRFOR 3 CR with electrical resistance
AIRFOR 3 WALL at room temperature	ARIA 1 POTENZA at room temperature

! Very important:

By room-temperature air curtains, we mean that the air in the interior is taken in through the upper grid or the front grid and blown downwards to the ground so the blown air keeps the internal environment temperature constant.

! Very important:

For air curtains with electrical resistance or with hot water coil with intake from the upper or front grid, the air is heated and blown downwards to the ground. Therefore the blown-air temperature is higher than that of the internal environment.

For no reason this can warm up the environment or can be confused with a heating appliance.

Its main purpose is to suitably heat the air from the curtain, making the entrance of the customers into the environment pleasant and comfortable during winter.

! The installation of the automatic start kit provides the start up of the curtains at the maximum speed, ignoring other settings. In models with electrical resistance, the resistance is not enabled.

CHOICE OF THE BUILT-IN AIR CURTAIN

INFORMATION GATHERING

This type of air curtain is ideal for all contexts with a false ceiling because it is installed into the false ceiling to fit flush, giving a very attractive aesthetic result.

The built-in air curtain can have centrifugal or tangential motor, which operate either at room temperature or with electrical resistance. **It must be always mounted at the centre of the doors.**

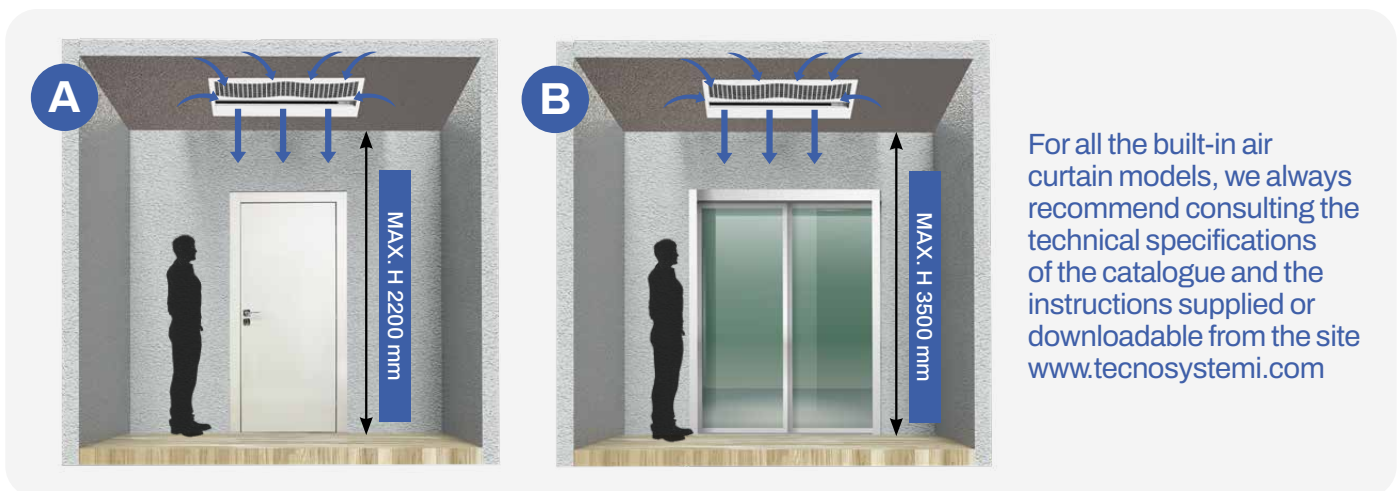

AIR CURTAINS WITH ASSEMBLY OF TYPE A

ARIA 2 ELEGANCE T at room temperature

ARIA 2 ELEGANCE TR with electrical resistance

BUILT-IN TANGENTIAL AIR CURTAINS TYPE B

AIR 2 ELEGANCE at room temperature

ARIA 2 ELEGANCE CR with electrical resistance

! Very important:

By built-in, room-temperature air curtains, we mean that the air in the interior is taken in through the grid and blown downward to the ground. So the blown air keeps the internal environment temperature constant.

! Very important:

By built-in air curtains with electrical resistance we mean that the air in the interior is taken in through the grid, heated by the resistance and blown downward to the ground. So the blown-air temperature is higher than that of the internal environment.

For no reason can this warm up the environment or confused with a heating appliance. Its main purpose is to suitably heat the air from the curtain, making the entrance of the customers into the environment pleasant and comfortable during winter.

! **The installation of the automatic start kit provides the startup of the curtains at the maximum speed, ignoring other settings. In models with electrical resistance, the resistance is not turned on.**

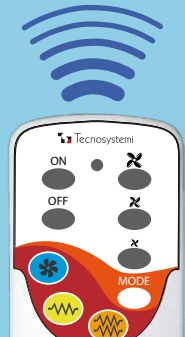
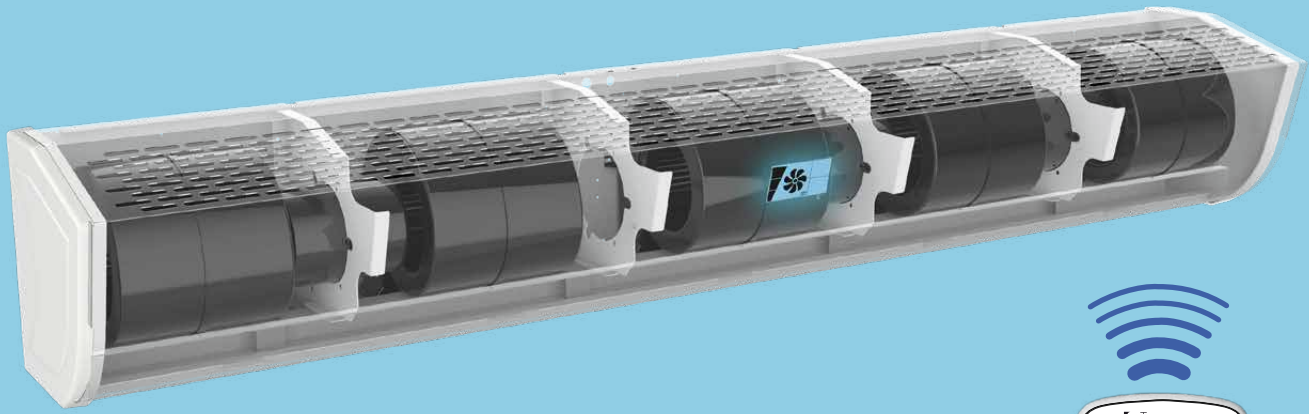

REMOTE CONTROL FUNCTIONS

Air curtain ON

Air curtain OFF

VENTILATION
Symbol of selected fan speed
(green LED)

1/2 LOAD RESISTANCE
The electric resistances installed operate at half load. This function is available only on air curtains with electric resistances.
(Yellow LED)

Change speed

Maximum speed

Medium speed

Low speed

Change mode

FULL LOAD RESISTANCE
The electric resistances installed operate at full load. This function is available only on air curtains with electric resistances.
(Orange LED)

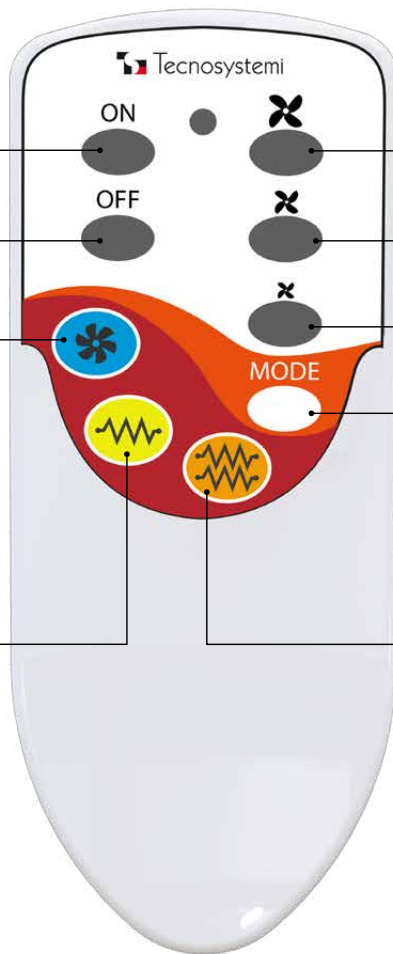

TANGENTIAL AIR CURTAIN



WHY CHOOSE A TANGENTIAL AIR CURTAIN?

Tangential air curtains operate on the **principle of the Coandă effect, which exploits the tendency of air to follow a curved surface.**

Tangential air curtains are generally suitable for small to medium sized domestic or commercial applications where an even distribution of airflow is required without causing acoustic disturbance.

🇬🇧 TANGENTIAL AIR CURTAIN WITH UPPER EXTRACTION

TECHNICAL SPECIFICATIONS

- 4 models in white
- 3 speeds operated by remote control
- Air curtains are designed for indoor use
- Panel with 3 LEDs
- Automatic starter kit on request
- Upper air intake
- The unit must be installed horizontally

🇫🇷 RIDEAU D'AIR TANGENTIELLE À ASPIRATION SUPÉRIEURE

CARACTÉRISTIQUES TECHNIQUES

- 4 modèles blancs
- 3 vitesses commandées par télécommande
- Les barrières à air sont conçues pour une utilisation à l'intérieur
- Tableau de bord avec 3 LED
- Kit de démarrage automatique sur demande
- Aspiration d'air supérieure
- L'unité doit être installée horizontalement

🇩🇪 TANGENTIAL-LUFTBARRIERE MIT ANSAUGUNG AN DER OBERSEITE

TECHNISCHE EIGENSCHAFTEN

- 4 Modelle in weißer Farbe
- 3 Geschwindigkeiten, mit Fernbedienung betrieben
- Luftschleier sind für die Verwendung in Innenräumen bestimmt
- Frontteil mit 3 LEDs
- Automatisches Starter-Kit auf Anfrage
- Obere Luftansaugung
- Das Gerät muss horizontal montiert werden



Accessories

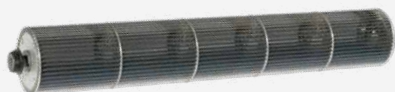

Tangential motor



Remote control included



Panel with 3 coloured leds

CODE	SUPPLY VOLTAGE [V]	FREQUENCY [Hz]	POWER CONSUMPTION [W]	AIR SPEED AT INLET [m/s]	AIR FLOW RATE [m³/h]	SOUND LEVEL [dB(A)]	WEIGHT [kg]	REMOTE CONTROL	SUITABLE FOR DOORS [mm]
CODE	TENSION D'ALIMENTATION [V]	FRÉQUENCE [Hz]	PUISSANCE ABSORBÉE [W]	VITESSE DE L'AIR À LA GRILLE [m/s]	DÉBIT D'AIR [m³/h]	NIVEAU SONORE [dB(A)]	POIDS [kg]	TÉLÉCOMMANDE	CONVIENT POUR PORTES [mm]
CODE	STROMVERSORGUNG [V]	FREQUENZ [Hz]	LEISTUNGSABNAHME [W]	LUFTGESCHWINDIGKEIT AN DER ÖFFNUNG [m/s]	LUFTDURCHFLUSSRATE [m³/h]	SCHALLPEGEL [dB(A)]	GEWICHT [kg]	FERNBEDIENUNGEN	GEEIGNET FÜR TÜREN [mm]
SINGLE-FAN TANGENTIAL AIR CURTAINS L: 1100 RIGHT - LEFT									
12300050I	230 ac	50	75	I:8 II:9 III:10	765 846 918	61 64 66	13,3	ADJUSTMENT SPEED	L.1000 H.3000
12300051									
DUAL-FAN TANGENTIAL AIR CURTAINS L: 1500 - 2000 CENTRAL									
12300055I	230 ac	50	190	I:8 II:9 III:10	1350 1458 1512	66 68 69	19,2	ADJUSTMENT SPEED	L.1500 H.3000
12300056I									

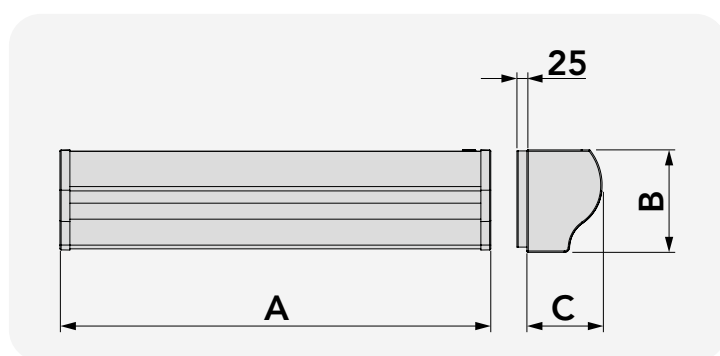

DIMENSIONS [mm]			
MODEL	A	B	C
1100 RIGHT	1085	250	185
1100 LEFT	1085	250	185
1500 CENTRAL	1440	250	185
2000 CENTRAL	2040	250	185

CODE	DESCRIPTION	U.M.	Pieces per box
12300050I	"ARIA3 SILENCE" TANGENTIAL SINGLE-FAN AIR CURTAINS 1100 DX	PCS	1
12300051I	"ARIA3 SILENCE" TANGENTIAL SINGLE-FAN AIR CURTAINS 1100 SX	PCS	1
12300055I	"ARIA3 SILENCE" TANGENTIAL DUAL-FAN AIR CURTAINS 1500 CEN.	PCS	1
12300056I	"ARIA3 SILENCE" TANGENTIAL DUAL-FAN AIR CURTAINS 2000 CEN.	PCS	1



TANGENTIAL AIR CURTAIN WITH UPPER EXTRACTION WITH SINGLE ELECTRICAL HEATING ELEMENT

TECHNICAL SPECIFICATIONS

- 8 models in white
- 3 speeds operated by remote control
- Air curtains are designed for indoor use
- Panel with coloured LEDs to indicate operating mode
- Automatic starter kit on request
- Upper air intake
- Electric heater operated by remote control
- The unit must be installed horizontally

RIDEAU D'AIR TANGENTIELLE À ASPIRATION SUPÉRIEURE AVEC 1 OU 2 RÉSISTANCE ÉLECTRIQUES

CARACTÉRISTIQUES TECHNIQUES

- 8 modèles blancs
- 3 vitesses commandées par télécommande
- Les barrières à air sont conçues pour une utilisation à l'intérieur
- Tableau de bord avec LED colorées pour le mode de fonctionnement de la signalisation
- Kit de démarrage automatique sur demande
- Aspiration d'air supérieure
- Résistance électrique commandée par télécommande
- L'unité doit être installée horizontalement

EINGEBAUTE TANGENTIAL-LUFTBARRIERE MIT ANSAUGUNG AN DER OBERSEITE MIT 1 ODER 2 ELEKTRISCHEN HEIZKÖRPER

TECHNISCHE EIGENSCHAFTEN

- 8 Modelle in weiße Farbe
- 3 Geschwindigkeiten, mit Fernbedienung betrieben
- Luftscheier sind für die Verwendung in Innenräumen bestimmt
- Frontteil mit farbigen LEDs für die Signalisierung der Betriebsart
- Automatisches Starter-Kit auf Anfrage
- Obere Luftansaugung
- Elektrischer Heizkörper, der über eine Fernbedienung gesteuert werden kann
- Das Gerät muss horizontal montiert werden



Accessories

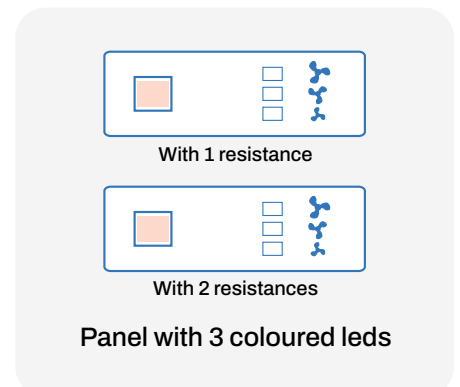
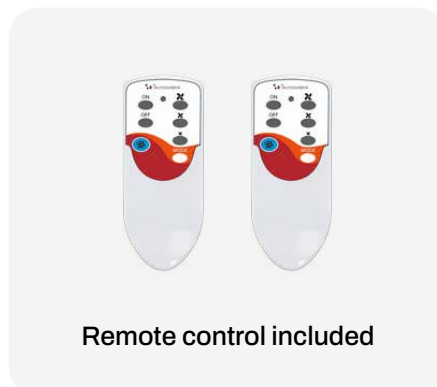

CODE	SUPPLY VOLTAGE [V]	FREQUENCY [Hz]	POWER CONSUMPTION [W]	POWER ABSORBED WITH RESISTANCE [W]	AIR SPEED AT INLET [m/s]	AIR FLOW RATE [m³/h]	SOUND LEVEL [dB(A)]	ΔT AIR WITH HEATING ELEMENTS	WEIGHT [kg]	REMOTE CONTROL	SUITABLE FOR DOORS [mm]
CODE	TENSION D'ALIMENTATION [V]	FRÉQUENCE [Hz]	PUISSANCE ABSORBÉE [W]	PUISSANCE ABSORBÉE AVEC RÉSTANCE [W]	VITESSE DE L'AIR À LA GRILLE [m/s]	DÉBIT D'AIR [m³/h]	NIVEAU SONORE [dB(A)]	ΔT AIR AVEC RÉSTANCES	POIDS [kg]	TÉLÉCOMMANDE	CONVIENT POUR PORTES [mm]
CODE	STROMVERSORGUNG [V]	FREQUENZ [Hz]	LEISTUNGS-AUFNAHME [W]	MIT WIDERSTAND AUFGENOMMENE LEISTUNG [W]	LUFTGESCHWINDIGKEIT AN DER ÖFFNUNG [m/s]	LUFTDURCHFLUSSRA-TE [m³/h]	SCHALL-PEGEL [dB(A)]	ΔT DER LUFT MIT WIDERSTÄNDEN	GEWICHT [kg]	FERNBEDIENUNGEN	GEEIGNET FÜR TÜREN [mm]

SINGLE-FAN TANGENTIAL AIR CURTAINS WITH 1 RESISTANCE L: 1100 WITH UPPER AIR INTAKE

12300050RI	230 ac	50	75	1900	I:7,5	693	65	12°	14.8	ADJUSTMENT SPEED ON/OFF resistant	L.1000 - H.3000
12300051R1					II:8		67				
					III:9	738	68				
						783					

DUAL-FAN TANGENTIAL AIR CURTAINS WITH 2 RESISTANCES L: 1500 - 2000 WITH UPPER AIR INTAKE

12300055RI	230 ac	50	190	3200	I:7,5	1161	68	12°	21.4	ADJUSTMENT SPEED ON/OFF resistant	L.1500 - H.3000
12300056RI				3800	II:8	1188	68,5				
					III:9	1215	69				
						1332	67				L.2000 - H.3000
						1404	68			28.6	
						1458	70				

N.B. The indicated temperature refers to the increase in temperature between the room and the air being discharged from the air curtain at minimum speed

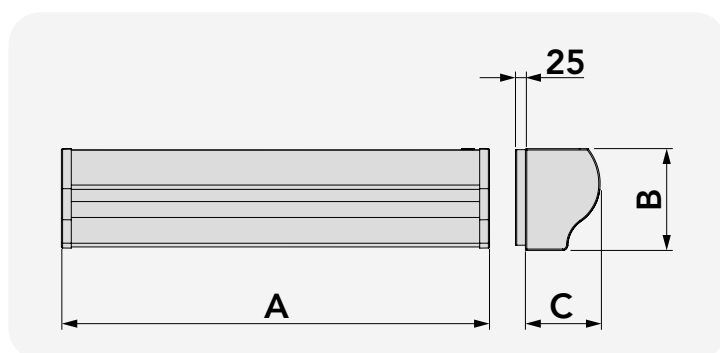

DIMENSIONS [mm]			
MODEL	A	B	C
1100 RIGHT	1085	250	185
1100 LEFT	1085	250	185
1500 CENTRAL	1440	250	185
2000 CENTRAL	2040	250	185

CODE	DESCRIPTION	U.M.	Pieces per box
12300050RI	"ARIA3 SILENCE" SINGLE-FAN AIR CURTAINS WITH 1 RESISTANCE 1100 DX RESIST.	PCS	1
12300051R1	"ARIA3 SILENCE" SINGLE-FAN AIR CURTAINS WITH 1 RESISTANCE 1100 SX RESIST.	PCS	1
12300055RI	"ARIA3 SILENCE" DUAL-FAN AIR CURTAINS WITH 2 RESISTANCES 1500 CEN. RESIST.	PCS	1
12300056RI	"ARIA3 SILENCE" DUAL-FAN AIR CURTAINS WITH 2 RESISTANCES 2000 CEN. RESIST.	PCS	1



CODE	SUPPLY VOLTAGE [V]	FREQUENCY [Hz]	POWER CONSUMPTION [W]	PARTIAL LOAD HEATING ELEMENT POWER [W]	TOTAL LOAD HEATING ELEMENT POWER [W]	AIR SPEED AT INLET [m/s]	AIR FLOW RATE [m³/s]	SOUND LEVEL [dB(A)]	ΔT AIR WITH HEATING ELEMENTS	WEIGHT [kg]	REMOTE CONTROL	SUITABLE FOR DOORS [mm]
CODE	TENSION D'ALIMENTATION [V]	FRÉQUENCE [Hz]	PUISSANCE ABSORBÉE [W]	PUISSANCE RÉSTANCES CHARGE PARTIELLE [W]	PUISSANCE RÉSTANCES CHARGE TOTALE [W]	VITESSE DE L'AIR À LA GRILLE [m/s]	DÉBIT D'AIR [m³/s]	NIVEAU SONORE [dB(A)]	ΔT AIR AVEC RÉSTANCES	POIDS [kg]	TÉLÉCOMMANDE	CONVIENT POUR PORTES [mm]
CODE	STROMVERSORGUNG [V]	FREQUENZ [Hz]	LEISTUNGS-AUFNAHME [W]	TEILLASTWIDERSTANDSLEISTUNG [W]	VOLLSTWIDERSTANDSLEISTUNG [W]	LUFTGESCHWINDIGKEIT AN DER ÖFFNUNG [m/s]	LUFTDURCHFLOßSRATE [m³/s]	SCHALLPEGEL [dB(A)]	ΔT DER LUFT MIT WIDERSTÄNDEN	GEWICHT [kg]	FERNBEDIENUNGEN	GEEIGNET FÜR TÜREN [mm]

FAN TANGENTIAL AIR CURTAINS WITH 2 RESISTANCES L: 1100 WITH UPPER AIR INTAKE

12300050RI2	230 ac	50	75	1900	3800	I:7,5	675	64	25°	15.7	ADJUSTMENT 3 SPEED AND ON/OFF RESISTANCE	L.1000 - H.3000
12300051RI2						II:8		65				

DUAL-FAN TANGENTIAL AIR CURTAINS WITH 4 RESISTANCES L: 1500 - 2000 WITH UPPER AIR INTAKE

12300055RI2	400 ac	50	190	3200	6400	I:7,5	1134	66	25°	22.3	3 SPEED AND ON/OFF RESISTANCE	L.1500 - H.3000
12300056RI2				3800	7600	II:8	1174	67				

N.B. The indicated temperature refers to the increase in temperature between the room and the air being discharged from the air curtain at minimum speed

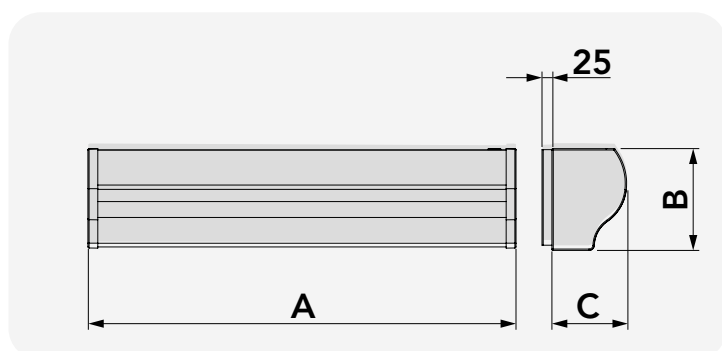

DIMENSIONS [mm]			
MODEL	A	B	C
1100 RIGHT	1085	250	185
1100 LEFT	1085	250	185
1500 CENTRAL	1440	250	185
2000 CENTRAL	2040	250	185

CODE	DESCRIPTION	U.M.	Pieces per box
12300050RI2	"ARIA3 SILENCE" RESIDENTIAL DUAL-FAN AIR CURTAINS WITH 2 RESISTANCES 1100 DX	PCS	1
12300051RI2	"ARIA3 SILENCE" RESIDENTIAL DUAL-FAN AIR CURTAINS WITH 2 RESISTANCES 1100 SX	PCS	1
12300055RI2	"ARIA3 SILENCE" RESIDENTIAL DUAL-FAN AIR CURTAINS WITH 4 RESISTANCES 1500 CEN	PCS	1
12300056RI2	"ARIA3 SILENCE" RESIDENTIAL DUAL-FAN AIR CURTAINS WITH 4 RESISTANCES 2000 CEN	PCS	1



ARIA 3 SILENCE FRONT

MADE IN ITALY



Aria3
SILENCE FRONT

TANGENTIAL AIR CURTAIN WITH FRONT EXTRACTION

TECHNICAL SPECIFICATIONS

- 4 models in white
- 3 speeds operated by remote control
- Air curtains are designed for indoor use
- Panel with 3 LEDs
- Automatic start-up kit on request
- Front air intake
- The unit must be installed horizontally

RIDEAU D'AIR TANGENTIELLE À ASPIRATION FRONTALE

CARACTÉRISTIQUES TECHNIQUES

- 4 modèles blancs
- 3 vitesses commandées par télécommande
- Les barrières à air sont conçues pour une utilisation à l'intérieur
- Tableau de bord avec 3 LED
- Kit de démarrage automatique sur demande
- Aspiration air frontale
- L'unité doit être installée horizontalement

TANGENTIAL-LUFTBARRIERE MIT FRONTANSAUGUNG

TECHNISCHE EIGENSCHAFTEN

- 4 Modelle in weiße Farbe
- 3 Geschwindigkeiten, mit Fernbedienung betrieben
- Luftschleier sind für die Verwendung in Innenräumen bestimmt
- Frontteil mit 3 LEDs
- Automatisches Anlaufset auf Anfrage
- Frontluftabsaugung
- Das Gerät muss horizontal montiert werden

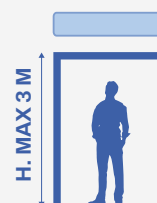

 AT ROOM TEMPERATURE

Accessories

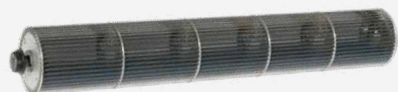

Tangential motor



Remote control included



Panel with 3 coloured leds

	CODE	SUPPLY VOLTAGE [V]	FREQUENCY [Hz]	POWER CONSUMPTION [W]	AIR SPEED AT INLET [m/s]	AIR FLOW RATE [m³/h]	SOUND POWER LEVEL [dB(A)]	WEIGHT [kg]	REMOTE CONTROL	SUITABLE FOR LARGE DOORS [mm]
	CODE	TENSION D'ALIMENTATION [V]	FRÉQUENCE [Hz]	PUISSANCE ABSORBÉE [W]	VITESSE DE L'AIR À LA GRILLE [m/s]	DÉBIT D'AIR [m³/h]	NIVEAU DE PUISSANCE ACOUSTIQUE [dB(A)]	POIDS [kg]	TÉLÉCOMMANDE	CONVIENT POUR PORTAILS [mm]
	CODE	STROMVERSORGUNG [V]	FREQUENZ [Hz]	LEISTUNGS-AUFNAHME [W]	LUFTGESCHWINDIGKEIT AN DER ÖFFNUNG [m/s]	LUFTDURCHFLUSSRA-TE [m³/h]	SCHALLLEISTUNGSPE-GE L [dB(A)]	GEWICHT [kg]	FERNBEDIENUN-GEN	GEEIGNET FÜR TÜREN [mm]

SINGLE-FAN TANGENTIAL AIR CURTAINS: 1100 RIGHT - LEFT

12400011	230 ac	50	75	I:9	963	50	11,2	ADJUSTMENT SPEED	L.1000 H.3000
12400013				II:10	1080	53			
				III:11	1152	55			

DUAL-FAN TANGENTIAL AIR CURTAINS L: 1500 - 2000

12400021	230 ac	50	190	I:9	1416	54	14,7	ADJUSTMENT SPEED	L.1500 H.3000
12400031				II:10	1520	55			
				III:11	1550	56			
				I:9	1494	64	20,1		L.2000 H.3000
				II:10	1692	66			
				III:11	1818	68			

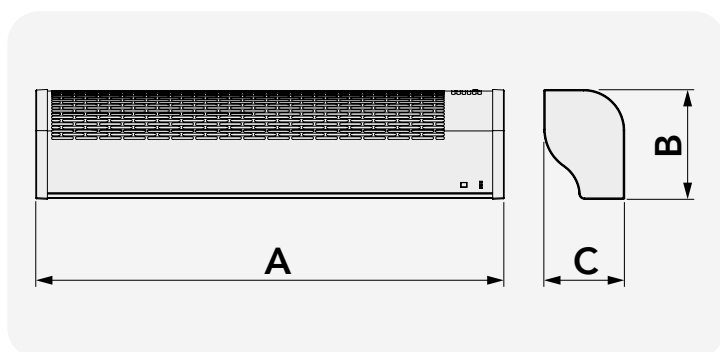

DIMENSIONS [MM]			
MODEL	A	B	C
1100 RIGHT	1070	245	180
1100 LEFT	1070	245	180
1500 CENTRAL	1422	245	180
2000 CENTRAL	2032	245	180

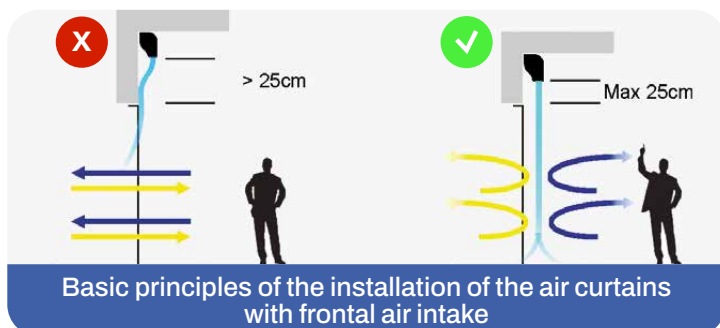

CODE	DESCRIPTION	U.M.	Pieces per box
12400011	"ARIA3 SILENCE FRONT" SINGLE-FAN AIR CURTAINS 1100 DX	PCS	1
12400013	"ARIA3 SILENCE FRONT" SINGLE-FAN AIR CURTAINS 1100 SX	PCS	1
12400021	"ARIA3 SILENCE FRONT" DUAL-FAN AIR CURTAINS 1500 CEN.	PCS	1
12400031	"ARIA3 SILENCE FRONT" DUAL-FAN AIR CURTAINS 2000 CEN.	PCS	1



THREE-PHASE TANGENTIAL AIR CURTAIN WITH TOP SUCTION AND PTC ELECTRIC HEATER

TECHNICAL SPECIFICATIONS

- 3 models in white
- Front body in alluminium
- PTC heating elements
- Barriers designed for indoor use
- Horizontal installation
- Control buttons on the front body
- Remote control for 2 speed control
- 3 heating levels
- Punctual LED for heating level indication

RIDEAU D'AIR TANGENTIEL TRIPHASÉ À ASPIRATION SUPÉRIEURE AVEC RÉSI-STANCE ÉLECTRIQUE PTC

CARACTÉRISTIQUES TECHNIQUES

- 3 modèles blancs
- Structure en aluminium
- Résistances chauffantes PTC
- Barrières conçues pour une utilisation en intérieur
- Installation horizontale
- Touches de commande sur la coque avant
- Télécommande pour contrôle de 2 vitesses
- 3 niveaux de chauffage
- LED ponctuelle pour indication de niveau de chauffage

DREIPHASIGER TANGENTIALER LUFTVORHANG MIT OBERER ANSAUGUNG UND PTC-ELEKTROHEIZUNG

TECHNISCHE EIGENSCHAFTEN

- 3 Modelle in weiße Farbe
- Vorderes gehäuse aus Aluminium
- Heizwiderstände PTC
- Barrieren für den Innenbereich
- Horizontale Montage
- Bedientasten an der Frontschale
- Fernbedienung für 2 Geschwindigkeitsstufen
- 3 Heizstufen
- Punktled zur Angabe der Heizstufe

Accessories supplied



Tangential motor & Remote control

380V

WITH PTC HEATING ELEMENT

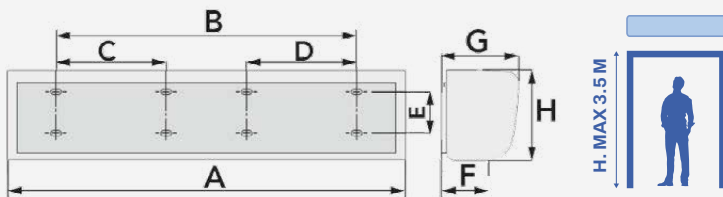

DIMENSIONS [mm]

MOD.	A	B	C	D	E	F	G	H
1200	1200	440	--	--	90	132	218	247
1500	1500	440	--	--	90	132	218	247
2000	2000	660	330	330	90	132	218	247

-- fixing holes not present

MOD.	CODE	SUPPLY VOLTAGE [V]	FREQUENCY [Hz]	POWER CONSUMPTION [W]	AIR SPEED AT INLET [m/s]	AIR FLOW RATE [m³/s]	POWER [kW]	SOUND POWER LEVEL [dB(A)]	WEIGHT [kg]	SUITABLE FOR LARGE DOORS [mm]
1200	AAD200001	380	50	I: 330 - II: 380	I: 1950 - II: 2400	I: 9 - II: 11	min: 3,5 - med: 7 - max: 10	I: 60 - II: 62	19	L.1200 / H.3500
1500	AAD200002	380	50	I: 400 - II: 490	I: 2550 - II: 3150	I: 9 - II: 11	min: 4 - med: 8 - max: 12	I: 61 - II: 63	22.5	L.1500 / H.3500
2000	AAD200003	380	50	I: 440 - II: 560	I: 2900 - II: 3540	I: 9 - II: 11	min: 5 - med: 10 - max: 16	I: 63 - II: 65	31	L.2000 / H.3500

CODE	DESCRIPTION	U.M.	Pieces per box
AAD200001	3-PHASES AIR CURTAIN WITH HEATING ELEMENT PTC 1200 "ARIA 4 INNOVATION"	PCS	1
AAD200002	3-PHASES AIR CURTAIN WITH HEATING ELEMENT PTC 1500 "ARIA 4 INNOVATION"	PCS	1
AAD200003	3-PHASES AIR CURTAIN WITH HEATING ELEMENT PTC 2000 "ARIA 4 INNOVATION"	PCS	1



🇬🇧 SINGLE-PHASE TANGENTIAL AIR CURTAIN WITH TOP SUCTION AND PTC ELECTRIC HEATER

TECHNICAL SPECIFICATIONS

- 2 models in white
- Front body in aluminium
- PTC heating elements
- Barriers designed for indoor use
- Horizontal installation
- Control buttons on the front body
- Remote control for 2 speed control
- 3 heating levels
- Punctual LED for heating level indication

🇫🇷 RIDEAU D'AIR TANGENTIEL MONOPHASÉ À ASPIRATION SUPÉRIEURE AVEC RÉSISTANCE ÉLECTRIQUE PTC

CARACTÉRISTIQUES TECHNIQUES

- 2 modèles blancs
- Structure en aluminium
- Résistances chauffantes PTC
- Barrières conçues pour une utilisation en intérieur
- Installation horizontale
- Touches de commande sur la coque avant
- Télécommande pour contrôle de 2 vitesses
- 3 niveaux de chauffage
- LED ponctuelle pour indication de niveau de chauffage

🇩🇪 EINPHASIGER TANGENTIALER LUFTVORHANG MIT OBERER ANSAUGUNG UND PTC-ELEKTROHEIZUNG

TECHNISCHE EIGENSCHAFTEN

- 2 Modelle in weiße Farbe
- Vorderes gehäuse aus Aluminium
- Heizwiderstände PTC
- Barrieren für den Innenbereich
- Horizontale Montage
- Bedientasten an der Frontschale
- Fernbedienung für 2 Geschwindigkeitsstufen
- 3 Heizstufen
- Punktled zur Angabe der Heizstufe

Accessories supplied



Tangential motor & Remote control

230V

WITH PTC HEATING ELEMENT

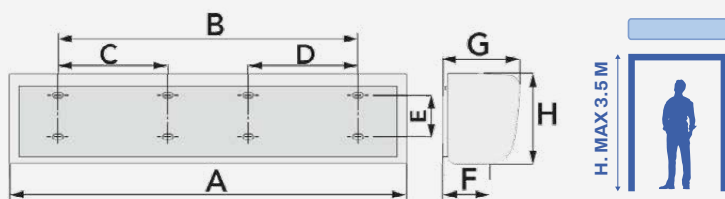

DIMENSIONS [mm]

MOD.	A	B	C	D	E	F	G	H
900	900	440	--	--	90	132	218	247
1200	1200	440	--	--	90	132	218	247

-- fixing holes not present

MOD.	CODE	SUPPLY VOLTAGE [V]	FREQUENCY [Hz]	POWER CONSUMPTION [W]	AIR SPEED AT INLET [m/s]	AIR FLOW RATE [m³/s]	POWER [kW]	SOUND POWER LEVEL [dB(A)]	WEIGHT [kg]	SUITABLE FOR LARGE DOORS [mm]
900	AAC200001	230	50	I: 200 - II: 260	I: 1300 - II: 1600	I: 7,5 - II: 9,5	min: 2 - med: 4 - max: 6	I: 59 - II: 61	15.5	L.900 / H.3500
1200	AAC200002	230	50	I: 330 - II: 380	I: 1950 - II: 24000	I: 7,5 - II: 9,5	min: 2 - med: 4 - max: 6	I: 60 - II: 62	19	L.1200 / H.3500

CODE	DESCRIPTION	U.M.	Pieces per box
AAC200001	AIR CURTAIN B "ARIA 4 INNOVATION-M" SINGLE PHASE WITH PTC HEATING ELEMENT L900	PCS	1
AAC200002	AIR CURTAIN "ARIA 4 INNOVATION-M" SINGLE PHASE WITH PTC HEATING ELEMENT PTC L1200	PCS	1





BUILT-IN TANGENTIAL AIR CURTAIN AT ROOM TEMPERATURE

TECHNICAL SPECIFICATIONS

- 3 models in white
- 3 speeds operated by remote control
- Air curtains are designed for indoor use
- Total integration to the false ceiling
- The unit must be installed horizontally
- Maximum installation height 2.2 m

RIDEAU D'AIR TANGENTIELLE INTÉGRÉE À TEMPÉRATURE AMBIANTE

CARACTÉRISTIQUES TECHNIQUES

- 3 modèles blancs
- 3 vitesses commandées par télécommande
- Les barrières à air sont conçues pour une utilisation à l'intérieur
- Intégration totale au faux plafond
- L'unité doit être installée horizontalement
- Hauteur maximale d'installation 2,2 m

EINGEBAUTE TANGENTIAL-LUFTBARRIERE BEI RAUMTEMPERATUR

TECHNISCHE EIGENSCHAFTEN

- 3 Modelle in weiße Farbe
- 3 Geschwindigkeiten, mit Fernbedienung betrieben
- Luftschleier sind für die Verwendung in Innenräumen bestimmt
- Vollständige Integration in die Zwischendecke
- Das Gerät muss horizontal installiert werden
- Maximale Einbauhöhe 2,2 m

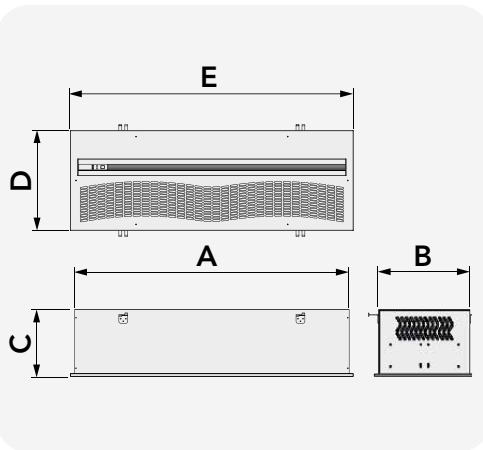

DIMENSIONS [mm]					
MOD.	A	B	C	D	E
1100	1086	362	270	396	1120
1500	1440	362	270	396	1472
2000	2040	362	270	396	2072

Accessories

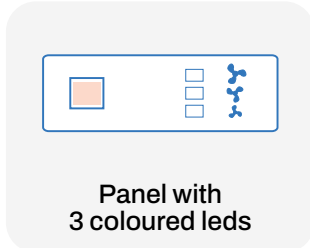

	CODE	SUPPLY VOLTAGE [V]	FREQUENCY [Hz]	POWER CONSUMPTION [W]	AIR SPEED AT INLET [m/s]	AIR FLOW RATE [m³/s]	SOUND POWER LEVEL [dB(A)]	WEIGHT [kg]	SUITABLE FOR LARGE DOORS [mm]
	CODE	TENSION D'ALIMENTATION [V]	FRÉQUENCE [Hz]	PUISANCE ABSORBÉE [W]	VITESSE DE L'AIR À LA GRILLE [m/s]	DÉBIT D'AIR [m³/s]	NIVEAU DE PUISSANCE ACOUSTIQUE [dB(A)]	POIDS [kg]	CONVIENT POUR PORTAILS [mm]
	CODE	STROMVERSORGUNG [V]	FREQUENZ [Hz]	LEISTUNGS-AUFNAHME [W]	LUFTGESCHWINDIGKEIT AN DER ÖFFNUNG [m/s]	LUFTDURCHFLUSSRA-TE [m³/s]	SCHALLLEISTUNGSPEGEL [dB(A)]	GEWICHT [kg]	GEEIGNET FÜR TÜREN [mm]
	12450014	230 ac	50	75	I:8 II:9 III:10	I:706 II:768 III:967	I:46 II:51 III:53	22	L.1000 H.Max.2200 H.Min.1800
	12450024	230 ac	50	190	I:8 II:9 III:10	I:1135 II:1238 III:1289	I:50 II:53 III:54	33	L.1500 H.Max.2200 H.Min.1800
	12450034	230 ac	50	190	I:8 II:9 III:10	I:1419 II:1560 III:1635	I:48 II:51 III:52	47	L.2000 H.Max.2200 H.Min.1800

CODE	DESCRIPTION	U.M.	Pieces per box
12450014	"ARIA 2 ELEGANCE T" 1100 BUILT-IN TANGENTIAL AIR CURTAINS AT ROOM TEMPERATURE	PCS	1
12450024	"ARIA 2 ELEGANCE T" 1500 BUILT-IN TANGENTIAL AIR CURTAINS AT ROOM TEMPERATURE	PCS	1
12450034	"ARIA 2 ELEGANCE T" 2000 BUILT-IN TANGENTIAL AIR CURTAINS AT ROOM TEMPERATURE	PCS	1



 **BUILT-IN TANGENTIAL AIR CURTAIN WITH ELECTRICAL HEATING ELEMENT**

TECHNICAL SPECIFICATIONS

- 6 models in white
- 3 speeds operated by remote control
- Air curtains are designed for indoor use
- Automatic start-up kit on request
- Total integration in the false ceiling
- Option to partialise operation of electric elements
- The unit must be installed horizontally
- Installation height max. 2.2 m

 **RIDEAU D'AIR TANGENTIELLE INTÉGRÉE À RÉISTANCE ÉLECTRIQUE**

CARACTÉRISTIQUES TECHNIQUES

- 6 modèles blancs
- 3 vitesses commandées par télécommande
- Les barrières à air sont conçues pour une utilisation à l'intérieur
- Kit de démarrage automatique sur demande
- Intégration totale dans le faux plafond
- Possibilité de partialiser le fonctionnement des résistances électriques
- L'unité doit être installée horizontalement
- Hauteur d'installation max. 2,2 m

 **EINGEBAUTE TANGENTIAL LUFT MIT ELEKTRISCHEM HEIZKÖRPER**

TECHNISCHE EIGENSCHAFTEN

- 6 Modelle in weiße Farbe
- 3 Geschwindigkeiten, mit Fernbedienung betrieben
- Luftschleier sind für die Verwendung in Innenräumen bestimmt
- Automatisches Anlaufset auf Anfrage
- Vollständige Integration in der Zwischendecke
- Möglichkeit der Einschränkung des Betriebs von elektrischen Heizgeräten
- Das Gerät muss horizontal installiert werden
- Einbauhöhe max. 2,2 m

 WITH ELETRIC RESISTANCE

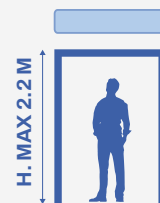

Accessories

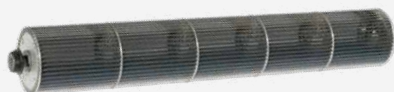

Tangential motor



Remote control included



Panel with 3 coloured leds

CODE	SUPPLY VOLTAGE [V]	FREQUENCY [Hz]	POWER CONSUMPTION [W]	AIR SPEED AT INLET [m/s]	POWER CONSUMPTION WITH PARTIAL LOAD RESISTANCE [W]	POWER ABSORBED WITH FULL LOAD RESISTANCE [W]	AIR FLOW RATE [m³/s]	SOUND POWER LEVEL [dB(A)]	ΔT AIR WITH HEATING ELEMENTS [°C]	WEIGHT [kg]	SUITABLE FOR LARGE DOORS [mm]
CODE	TENSION D'ALIMENTATION [V]	FRÉQUENCE [Hz]	PUISSANCE ABSORBÉE [W]	VITESSE DE L'AIR À LA GRILLE [m/s]	PUISSANCE ABSORBÉE AVEC RÉSTANCE DE CHARGE PARTIELLE [W]	PUISSANCE ABSORBÉE AVEC RÉSTANCE À PLEINE CHARGE [W]	DÉBIT D'AIR [m³/s]	NIVEAU DE PUISSANCE ACOUSTIQUE [dB(A)]	ΔT AIR AVEC RÉSTANCES [°C]	POIDS [kg]	CONVIENT POUR PORTAILS [mm]
CODE	STROMVERSORGUNG [V]	FREQUENZ [Hz]	LEISTUNGSAUFNAHME [W]	LUFTGESCHWINDIGKEIT AN DER ÖFFNUNG [m/s]	LEISTUNGSAUFNAHME BEI TEILLASTWIDERSTAND [W]	LEISTUNGSAUFNAHME BEI VOLLASTWIDERSTAND [W]	LUFTDURCHFLUSSRATE [m³/s]	SCHALLLEISTUNGSPEREGEL [dB(A)]	ΔT DER LUFT MIT WIDERSTÄNDEN [°C]	GEWICHT [kg]	GEEIGNET FÜR TÜREN [mm]

TANGENTIAL AIR CURTAINS WITH 2 ELECTRIC RESISTANCES

12450014R2	220 ac	50	75	I:8 II:9 III:10	1900	3800	I:692 II:753 III:948	I:47 II:52 III:54	12	23	L.1000 H.MAX.2200 H.MIN.1800
------------	--------	----	----	-----------------------	------	------	----------------------------	-------------------------	----	----	------------------------------------

TANGENTIAL AIR CURTAINS WITH 3 ELECTRIC RESISTANCES

12450014R3	400 ac	50	75	I:8 II:9 III:10	3800	5700	I:678 II:738 III:929	I:47 II:52 III:54	15	24	L.1000 H.MAX.2200 H.MIN.1800
------------	--------	----	----	-----------------------	------	------	----------------------------	-------------------------	----	----	------------------------------------

TANGENTIAL AIR CURTAINS WITH 4 ELECTRIC RESISTANCES

12450024R2	400 ac	50	190	I:8 II:9 III:10	3200	6400	I:1112 II:1213 III:1263	I:51 II:54 III:55	19	35	L.1500 H.MAX.2200 H.MIN.1800
12450024R3	400 ac	50	190	I:8 II:9 III:10	3800	7600	I:1090 II:1189 III:1238	I:49 II:52 III:53	19	49	L.2000 H.MAX.2200 H.MIN.1800

TANGENTIAL AIR CURTAINS WITH 6 ELECTRIC RESISTANCES

12450034R2	400 ac	50	190	I:8 II:9 III:10	6400	9600	I:1090 II:1189 III:1238	I:52 II:55 III:56	25	36	L.1500 H.MAX.2200 H.MIN.1800
12450034R3	400 ac	50	190	I:8 II:9 III:10	7600	11400	I:1068 II:1165 III:1213	I:50 II:53 III:54	25	50	L.2000 H.MAX.2200 H.MIN.1800

DIMENSIONS [mm]

MODEL	A	B	C	D	E
1100	1086	362	270	396	1120
1500	1086	362	270	396	1120
2000	1440	362	270	396	1472

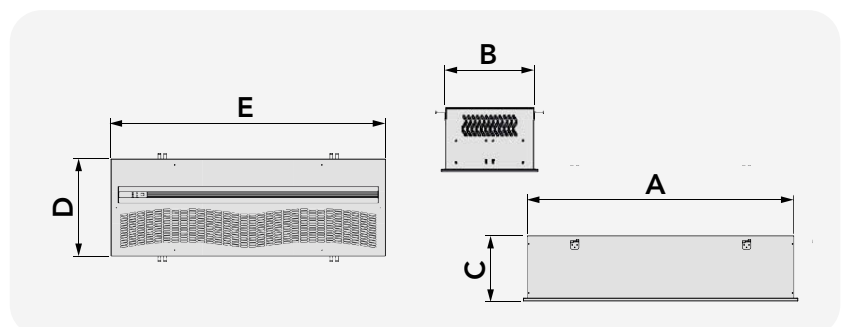

CODE	DESCRIPTION	U.M.	Pieces per box
12450014R2	"ARIA 2 ELEGANCE TR" 1100 TANGENTIAL AIR CURTAINS WITH 2 ELECTRIC HEATING ELEMENTS	PCS	1
12450014R3	"ARIA 2 ELEGANCE TR" 1100 TANGENTIAL AIR CURTAINS WITH 3 ELECTRIC HEATING ELEMENTS	PCS	1
12450024R2	"ARIA 2 ELEGANCE TR" 1500 TANGENTIAL AIR CURTAINS WITH 4 ELECTRIC HEATING ELEMENTS	PCS	1
12450024R3	"ARIA 2 ELEGANCE TR" 1500 TANGENTIAL AIR CURTAINS WITH 6 ELECTRIC HEATING ELEMENTS	PCS	1
12450034R2	"ARIA 2 ELEGANCE TR" 2000 TANGENTIAL AIR CURTAINS WITH 4 ELECTRIC HEATING ELEMENTS	PCS	1
12450034R3	"ARIA 2 ELEGANCE TR" 2000 TANGENTIAL AIR CURTAINS WITH 6 ELECTRIC HEATING ELEMENTS	PCS	1



CENTRIFUGAL AIR CURTAIN



WHY CHOOSE A CENTRIFUGAL AIR CURTAIN?

Centrifugal air curtains use a **centrifugal fan**, creating a **high-speed radial air vortex**.

This type of air curtain is usually suitable for commercial and industrial applications where a powerful and direct air flow is required. **Air curtains help to maintain a comfortable indoor environment by preventing the escape of both hot and cold air.**

CENTRIFUGAL AIR CURTAIN WITH UPPER EXTRACTION WITH BUILT-IN LED BAR LIGHT

TECHNICAL SPECIFICATIONS

- 4 models in white
- 3 speeds selectable by remote control or interface
- Air curtains are designed for indoor use
- Automatic starter kit on request
- Lower bar with LED light strip
- Backlit LCD display
- Upper air intake
- The unit must be installed horizontally

RIDEAU D'AIR CENTRIFUGE À ASPIRATION SUPÉRIEURE AVEC LUMIÈRE À BARRE LED INTÉGRÉE

CARACTÉRISTIQUES TECHNIQUES

- 4 modèles blancs
- 3 vitesses sélectionnables par télécommande ou interface
- Les barrières à air sont conçues pour une utilisation à l'intérieur
- Kit de démarrage automatique sur demande
- Barre inférieure avec bande lumineuse LED
- Écran LCD rétroéclairé
- Aspiration d'air supérieure
- L'unité doit être installée horizontalement

ZENTRIFUGAL TANGENTIAL-LUFTBARRIERE MIT ANSAUGUNG AN DER OBERSEITE MIT EINGEBAU-TER LED-LEISTE

TECHNISCHE EIGENSCHAFTEN

- 4 Modelle in weiße Farbe
- 3 Geschwindigkeiten mit Fernbedienung oder Schnittstelle wählbar
- Luftschleier sind für die Verwendung in Innenräumen bestimmt
- Automatisches Starter-Kit auf Anfrage
- Untere Stange mit LED-Streifen
- LCD-Display hinterleuchtet
- Obere Luftansaugung
- Das Gerät muss horizontal montiert werden



LCD Display

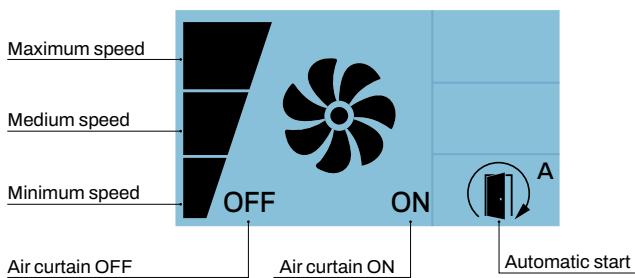

LED Light bar

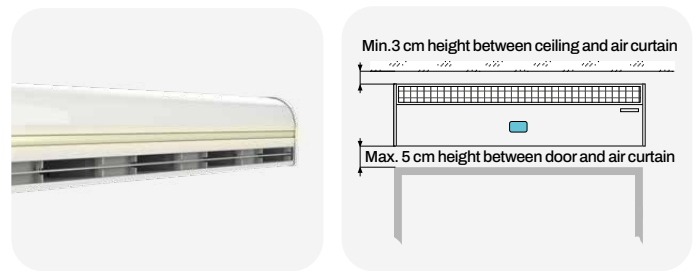

Accessories

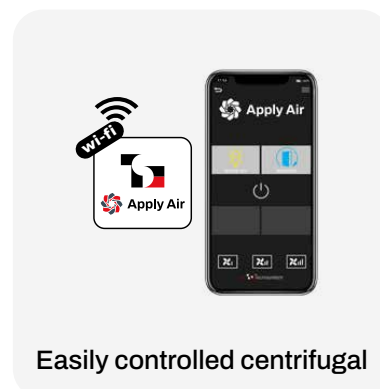
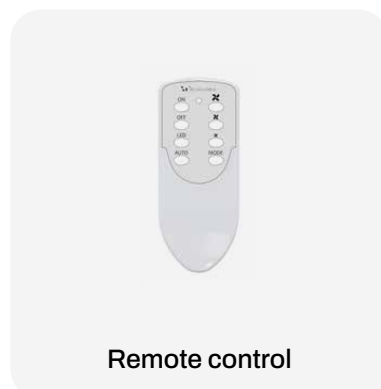



	MODEL	CODE	SUPPLY VOLTAGE [V]	FREQUENCY [Hz]	POWER CONSUMPTION [W]	AIR SPEED AT INLET [m/s]	AIR FLOW RATE [m³/h]	SOUND POWER LEVEL [dB(A)]	WEIGHT [kg]	SUITABLE FOR DOORS [mm]
	MODEL	CODE	TENSION [V] D'ALIMENTATION [V]	FRÉQUENCE [Hz]	PUISSANCE ABSORBÉE [W]	VITESSE DE L'AIR À LA GRILLE [m/s]	DÉBIT D'AIR [m³/h]	NIVEAU DE PUISSANCE ACOUSTIQUE [dB(A)]	POIDS [kg]	CONVIENT POUR PORTES [mm]
	MODEL	CODE	STROMVERSORGUNG [V]	FREQUENZ [Hz]	LEISTUNGSANNAHME [W]	LUFTGESCHWINDIGKEIT AN DER ÖFFNUNG [m/s]	LUFTDURCHFLUSSRAUM [m³/h]	SCHALLLEISTUNGSSPELGE [dB(A)]	GEWICHT [kg]	GEEIGNET FÜR TÜREN [mm]
900	AAD400001	230 ac	50	I:175 II:217 III:296	I:10 II:12,5 III:15	I:737 II:867 III:1020	I:50 II:52 III:53	12	L. 900 H. 3500	
1200	AAD400002	230 ac	50	I:235 II: 272 III:390	I:10 II:12,5 III:15	I:983 II:1156 III:1360	I:51 II:53 III:54	16	L. 1200 H. 3500	
1500	AAD400003	230 ac	50	I:272 II: 333 III:490	I:10 II:12,5 III:15	I:1225 II:1445 III:1700	I:53 II:54 III:56	20,6	L. 1500 H. 3500	
2000	AAD400004	230 ac	50	I:330 II: 393 III:590	I:10 II:12,5 III:15	I:1467 II:1734 III:2040	I:54 II:55 III:57	24,5	L. 2000 H. 3500	

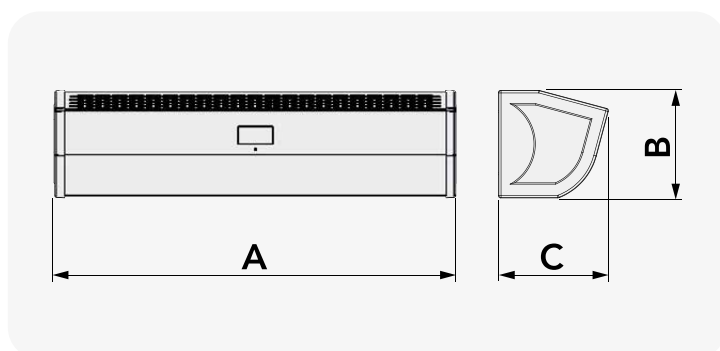

DIMENSIONS [mm]			
MODEL	A	B	C
900	900	240	250
1200	1200	240	250
1500	1500	240	250
2000	2000	240	250

Installation example



EXAMPLE OF DAY



EXAMPLE AT NIGHT WITH LED AIR CURTAIN ON

CODE	DESCRIPTION	U.M.	Pieces per box
AAD400001	"AIRJET 900" CENTRIFUGAL AIR CURTAIN W/UPPER AIR INTAKE AND INCORPORATED LED LIGHT BAR, L.900	PCS	1
AAD400002	"AIRJET 1200" CENTRIFUGAL AIR CURTAIN W/UPPER AIR INTAKE AND INCORPORATED LED LIGHT BAR, L.1100	PCS	1
AAD400003	"AIRJET 1500" CENTRIFUGAL AIR CURTAIN W/UPPER AIR INTAKE AND INCORPORATED LED LIGHT BAR, L.1500	PCS	1
AAD400004	"AIRJET 2000" CENTRIFUGAL AIR CURTAIN W/UPPER AIR INTAKE AND INCORPORATED LED LIGHT BAR, L.2000	PCS	1



CENTRIFUGAL AIR CURTAIN WITH UPPER EXTRACTION

TECHNICAL SPECIFICATIONS

- 2 models in white
- Operating temperature: + 50°C to -10°C
- 3 speeds operated by remote control or manually
- Air curtains are designed for indoor use.
- Upper air intake
- The unit must be installed horizontally
- Maximum installation height 3.5 m

RIDEAU D'AIR CENTRIFUGE À ASPIRATION SUPÉRIEURE

CARACTÉRISTIQUES TECHNIQUES

- 2 modèles blancs
- Température de fonctionnement : + 50°C à -10°C
- 3 vitesses commandées par télécommande ou manuellement
- Les barrières à air sont conçues pour une utilisation à l'intérieur.
- Aspiration d'air supérieure
- L'unité doit être installée horizontalement
- Hauteur maximale d'installation 3,5 m

ZENTRIFUGAL TANGENTIAL-LUFTBARRIERE MIT ANSAUGUNG AN DER OBERSEITE

TECHNISCHE EIGENSCHAFTEN

- 2 Modelle in weiße Farbe
- Betriebstemperatur: Von + 50°C bis -10°C
- 3 Geschwindigkeiten, mit Fernbedienung oder manuell betrieben
- Luftschleier sind für die Verwendung in Innenräumen bestimmt.
- Obere Luftansaugung
- Das Gerät muss horizontal installiert werden
- Maximale Einbauhöhe 3,5 m

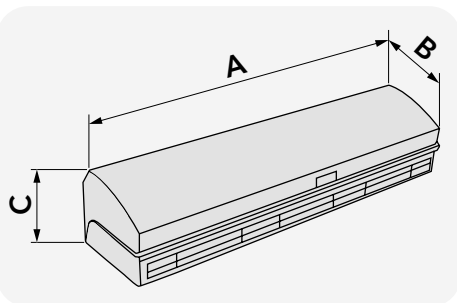

DIMENSIONS [mm]

MODEL	A	B	C
1000	1000	230	212
1500	1500	230	212

AT ROOM TEMPERATURE



UK	CODE	SUPPLY VOLTAGE [V]	FREQUENCY [Hz]	POWER CONSUMPTION [W]	AIR SPEED AT INLET [m/s]	AIR FLOW RATE [m³/h]	SOUND POWER LEVEL [dB(A)]	REMOTE CONTROL	WEIGHT [kg]	SUITABLE FOR LARGE DOORS [mm]
FR	CODE	TENSION D'ALIMENTATION [V]	FRÉQUENCE [Hz]	PUISSANCE ABSORBÉE [W]	VITESSE DE L'AIR À LA GRILLE [m/s]	DÉBIT D'AIR [m³/h]	NIVEAU DE PUISSANCE ACOUSTIQUE [dB(A)]	TÉLÉCOMMANDE	POIDS [kg]	CONVIENT POUR PORTAILS [mm]
DE	CODE	STROMVERSORGUNG [V]	FREQUENZ [Hz]	LEISTUNGS-AUFNAHME [W]	LUFTGESCHWINDIGKEIT AN DER ÖFFNUNG [m/s]	LUFTDURCHFLUSSRATE [m³/h]	SCHALLLEISTUNGSPEGEL [dB(A)]	FERNBEDIENUNGEN	GEWICHT [kg]	GEEIGNET FÜR TÜREN [mm]
	12300038	230 ac	50	I:186 II:238 III: 322	I:9 II:11 III: 12,5	798	I:46 II:51 III:58	3-speed adjustment	16,9	L 1000 H 3500
	12300039	230 ac	50	I:291 II:381 III: 536	I:9 II:11 III: 12,5	1330	I:51 II:56 III: 62	3-speed adjustment	22,6	L1500 H3500

Accessories



CODE	DESCRIPTION	U.M.	Pieces per box
12300038	"AIRFOR3 UP" CENTRIFUGAL AIR CURTAIN WITH UPPER AIR INTAKE 1000	PCS	1
12300039	"AIRFOR3 UP" CENTRIFUGAL AIR CURTAIN WITH UPPER AIR INTAKE 1500	PCS	1



UPPER SUCTION CENTRIFUGAL AIR BARRIER WITH ABS SHELL

TECHNICAL SPECIFICATIONS

- 3 models in white
- Operating temperature: + 50°C to -10°C
- 3 speeds operated by remote control or manually
- Air curtains are designed for indoor use.
- Upper air intake
- The unit must be installed horizontally
- Maximum installation height 4 m

RIDEAU D'AIR CENTRIFUGE À ASPIRATION SUPÉRIEURE AVEC COQUE EN ABS

CARACTÉRISTIQUES TECHNIQUES

- 3 modèles blancs
- Température de fonctionnement : + 50°C à -10°C
- 3 vitesses commandées par télécommande ou manuellement
- Les barrières à air sont conçues pour une utilisation à l'intérieur.
- Aspiration d'air supérieure
- L'unité doit être installée horizontalement
- Hauteur maximale d'installation 4 m

OBERE ZENTRIFUGALE ANSAUGLUFTSCHLEUSE MIT ABS-GEHÄUSE

TECHNISCHE EIGENSCHAFTEN

- 3 Modelle in weiße Farbe
- Betriebstemperatur: Von + 50°C bis -10°C
- 3 Geschwindigkeiten, mit Fernbedienung oder manuell betrieben
- Luftschleier sind für die Verwendung in Innenräumen bestimmt.
- Obere Luftansaugung
- Das Gerät muss horizontal installiert werden
- Maximale Einbauhöhe 4 m

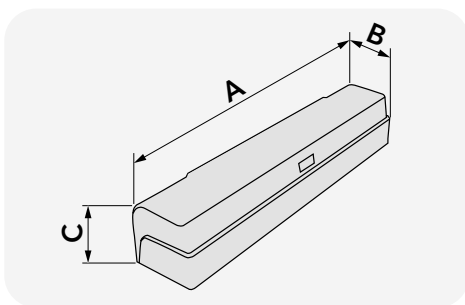

DIMENSIONS [mm]

MODEL	A	B	C
900	900	231	216
1200	1200	231	216
1500	1500	231	216



UK CODE	SUPPLY VOLTAGE [V]	FREQUENCY [Hz]	POWER CONSUMPTION [W]	AIR SPEED AT INLET [m/s]	AIR FLOW RATE [m³/h]	SOUND POWER LEVEL [dB(A)]	WEIGHT [kg]	REMOTE CONTROL	SUITABLE FOR LARGE DOORS [mm]
FR CODE	TENSION D'ALIMENTATION [V]	FRÉQUENCE [Hz]	PUISSANCE ABSORBÉE [W]	VITESSE DE L'AIR À LA GRILLE [m/s]	DÉBIT D'AIR [m³/h]	NIVEAU DE PUISSANCE ACOUSTIQUE [dB(A)]	POIDS [kg]	TÉLÉCOMMANDE	CONVIENT POUR PORTAILS [mm]
DE CODE	STROMVERSORGUNG [V]	FREQUENZ [Hz]	LEISTUNGSANNAHME [W]	LUFTGESCHWINDIGKEIT AN DER ÖFFNUNG [m/s]	LUFTDURCHFLOSSRAUM [m³/h]	SCHALLLEISTUNGSPEGEL [dB(A)]	GEWICHT [kg]	FERNBEDIENUNGEN	GEEIGNET FÜR TÜREN [mm]
AAC100001	230 ac	50	I:175 II:217 III:296	I:10 II:12,5 III:15	I:737 II:867 III:1020	I:50 II:52 III:53	12	3-speed adjustment	L900 H3000
12300044	230 ac	50	I:235 II:272 III:390	I:10 II:12,5 III:15	I:983 II:1156 III:1360	I:51 II:53 III:54	16	3-speed adjustment	L1200 H4000
123000445	230 ac	50	I:272 II:333 III:490	I:10 II:12,5 III:15	I:1225 II:1445 III:1700	I:53 II:53 III:56	20,6	3-speed adjustment	L1500 H4000

Accessories

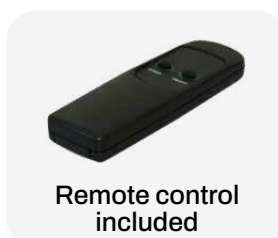

CODE	DESCRIPTION	U.M.	Pieces per box
AAC100001	"AIR FOR 3 STYLE" CENTRIFUGAL AIR CURTAIN WITH ABS PLASTIC BODY AND UPPER INTAKE, L.900	PCS	1
12300044	"AIRFOR3 STYLE" CENTRIFUGAL AIR CURTAIN WITH ABS PLASTIC BODY WITH UPPER AIR INTAKE 1200	PCS	1
123000445	"AIRFOR3 STYLE" CENTRIFUGAL AIR CURTAIN WITH ABS PLASTIC BODY WITH UPPER AIR INTAKE 1500	PCS	1



AIRFOR 3 FRONT



CENTRIFUGAL AIR CURTAIN WITH FRONT EXTRACTION

TECHNICAL SPECIFICATIONS

- 2 models in white
- Operating temperature + 50°C - 10°C
- 3 speeds operated by remote control or manually
- Air curtains are designed for indoor use
- Front air intake
- The unit must be installed horizontally
- Maximum installation height 3.5 m

RIDEAU D'AIR CENTRIFUGE D'ASPIRATION FRONTALE

CARACTÉRISTIQUES TECHNIQUES

- 2 modèles blancs
- Température de fonctionnement + 50°C - 10°C
- 3 vitesses commandées par télécommande ou manuellement
- Les barrières à air sont conçues pour une utilisation à l'intérieur
- Aspiration air frontale
- L'unité doit être installée horizontalement
- Hauteur maximale d'installation 3,5 m

ZENTRIFUGALLUFT MIT FRONTANSAUGUNG

TECHNISCHE EIGENSCHAFTEN

- 2 Modelle in weiße Farbe
- Betriebstemperatur + 50°C - 10°C
- 3 Geschwindigkeiten, mit Fernbedienung oder manuell betrieben
- Luftschleier sind für die Verwendung in Innenräumen bestimmt
- Frontluftabsaugung
- Das Gerät muss horizontal installiert werden
- Maximale Einbauhöhe 3,5 m

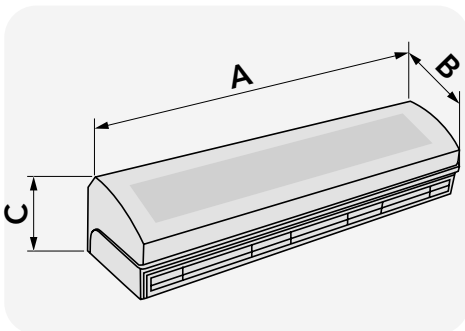

AT ROOM TEMPERATURE

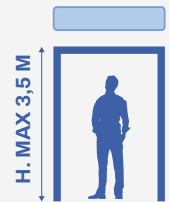

DIMENSIONS [mm]

MODEL	A	B	C
1000	1000	230	212
1500	1500	230	212

UK	CODE	SUPPLY VOLTAGE [V]	FREQUENCY [Hz]	POWER CONSUMPTION [W]	AIR SPEED AT INLET [m/s]	AIR FLOW RATE [m³/h]	SOUND POWER LEVEL [dB(A)]	WEIGHT [kg]	REMOTE CONTROL	SUITABLE FOR LARGE DOORS [mm]
FR	CODE	TENSION D'ALIMENTATION [V]	FRÉQUENCE [Hz]	PUISSANCE ABSORBÉE [W]	VITESSE DE L'AIR À LA GRILLE [m/s]	DÉBIT D'AIR [m³/h]	NIVEAU DE PUISSANCE ACOUSTIQUE [dB(A)]	POIDS [kg]	TÉLÉCOMMANDE	CONVIENT POUR PORTAILS [mm]
DE	CODE	STROMVERSORGUNG [V]	FREQUENZ [Hz]	LEISTUNGSANNAHME [W]	LUFTGESCHWINDIGKEIT AN DER ÖFFNUNG [m/s]	LUFTDURCHFLOSSRATEGIE [m³/h]	SCHALLLEISTUNGSPEGEL [dB(A)]	GEWICHT [kg]	FERNBEDIENUNGEN	GEEIGNET FÜR TÜREN [mm]
	12300036	230 ac	50	296	I:9 II:11 III:12,5	I:550 II:673 III:798	I:48 II:52 III:56	16,9	3-speed adjustment	L.1000 H.3500
	12300037	230 ac	50	490	I:9 II:11 III:12,5	I:939 II:1148 III:1330	I:52 II:57 III:62	22,6	3-speed adjustment	L.1500 H.3500

Accessories



CODE	DESCRIPTION	U.M.	Pieces per box
12300036	"AIRFOR3 FRONT" CENTRIFUGAL AIR CURTAIN WITH FRONTAL AIR INTAKE 1000	PCS	1
12300037	"AIRFOR3 FRONT" CENTRIFUGAL AIR CURTAIN WITH FRONTAL AIR INTAKE 1500	PCS	1



CENTRIFUGAL AIR CURTAIN WITH UPPER EXTRACTION

TECHNICAL SPECIFICATIONS

- 3 models in white with speed controller supplied
- Air curtains are designed for indoor use
- Upper air intake
- The unit must be installed horizontally.
- Maximum installation height 3 m

RIDEAU D'AIR CENTRIFUGE À ASPIRATION SUPÉRIEURE

CARACTÉRISTIQUES TECHNIQUES

- 3 modèles blancs avec régulateur de vitesse fourni
- Les barrières à air sont conçues pour une utilisation à l'intérieur
- Aspiration d'air supérieure
- L'unité doit être installée horizontalement.
- Hauteur maximale d'installation 3 m

ZENTRIFUGAL TANGENTIAL-LUFTBARRIERE MIT ANSAUGUNG AN DER OBERSEITE

TECHNISCHE EIGENSCHAFTEN

- 3 Modelle in weiße Farbe mit Drehzahlregler im Lieferumfang enthalten
- Luftschleier sind für die Verwendung in Innenräumen bestimmt
- Obere Luftansaugung
- Das Gerät muss horizontal montiert werden.
- Maximale Einbauhöhe 3 m

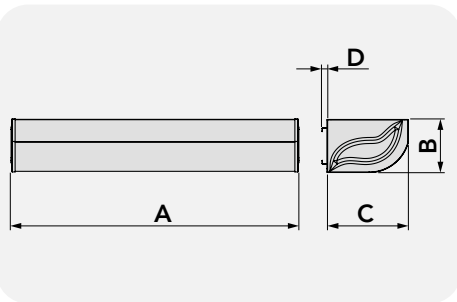

DIMENSIONS [mm]			
MODEL	A	B	C
1000	1012	279	455
1500	1512	279	455
2000	2012	279	455



	CODE	SUPPLY VOLTAGE [V]	FREQUENCY [Hz]	POWER CONSUMPTION [W]	AIR SPEED AT INLET [m/s]	AIR FLOW RATE [m³/h]	SOUND POWER LEVEL [dB(A)]	WEIGHT [kg]	SUITABLE FOR LARGE DOORS [mm]
	CODE	TENSION D'ALIMENTATION [V]	FRÉQUENCE [Hz]	PUISSANCE ABSORBÉE [W]	VITESSE DE L'AIR À LA GRILLE [m/s]	DÉBIT D'AIR [m³/h]	NIVEAU DE PUISSANCE ACOUSTIQUE [dB(A)]	POIDS [kg]	CONVIENT POUR PORTAILS [mm]
	CODE	STROMVERSORGUNG [V]	FREQUENZ [Hz]	LEISTUNGS-AUFNAHME [W]	LUFTGESCHWINDIGKEIT AN DER ÖFFNUNG [m/s]	LUFTDURCHFLUSSRATE [m³/h]	SCHALLLEISTUNGSPPEL [dB(A)]	GEWICHT [kg]	GEEIGNET FÜR TÜREN [mm]
	12450050	230 ac	50	192	12	1596	58	23,8	L1000 H3000
	12450060	230 ac	50	256	12.5	2125	60	32,8	L1500 H3000
	12450070	230 ac	50	384	13	3195	62	48,2	L2000 H3000

Accessories



CODE	DESCRIPTION	U.M.	Pieces per box
12450050	"AIRFOR3 WALL" CENTRIFUGAL AIR CURTAINS 1000	PCS	1
12450060	"AIRFOR3 WALL" CENTRIFUGAL AIR CURTAINS 1500	PCS	1
12450070	"AIRFOR3 WALL" AIR CURTAINS 2000	PCS	1



CENTRIFUGAL AIR CURTAIN WITH FRONT EXTRACTION WITH ELECTRIC HEATING ELEMENT

TECHNICAL SPECIFICATIONS

- 3 models in white with speed controller supplied
- 3 speeds operated by remote control
- Air curtains are designed for indoor use
- Front air intake
- The unit must be installed horizontally
- Maximum installation height 3.5 m

RIDEAU D'AIR CENTRIFUGE À ASPIRATION FRONTALE AVEC RÉSISTANCE ÉLECTRIQUE

CARACTÉRISTIQUES TECHNIQUES

- 3 modèles blancs avec régulateur de vitesse fourni
- 3 vitesses commandées par télécommande
- Les barrières à air sont conçues pour une utilisation à l'intérieur
- Aspiration air frontale
- L'unité doit être installée horizontalement
- Hauteur maximale d'installation 3,5 m

ZENTRIFUGALLUFT MIT FRONTANSAUGUNG MIT ELEKTRISCHEM HEIZKÖRPER

TECHNISCHE EIGENSCHAFTEN

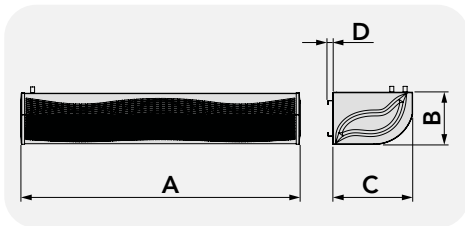

- 3 Modelle in weiße Farbe mit Drehzahlregler im Lieferumfang enthalten
- 3 Geschwindigkeiten, mit Fernbedienung betrieben
- Luftschleier sind für die Verwendung in Innenräumen bestimmt
- Frontluftabsaugung
- Das Gerät muss horizontal montiert werden
- Maximale Einbauhöhe 3,5 m



DIMENSIONS [mm]

MODEL	A	B	C	D
1000	1010	280	425	25
1500	1510	280	425	27
2000	2010	280	425	27



	CODE	SUPPLY VOLTAGE [V]	FREQUENCY [Hz]	POWER CONSUMPTION [W]	AIR SPEED AT INLET [m/s]	AIR FLOW RATE [m³/h]	SOUND POWER LEVEL [dB(A)]	ΔT AIR WITH HEATING ELEMENTS [°C]	POWER CONSUMPTION WITH PARTIAL LOAD RESISTANCE [W]	POWER ABSORBED WITH FULL LOAD RESISTANCE [W]	WEIGHT [kg]	SUITABLE FOR LARGE DOORS [mm]
	CODE	TENSION D'ALIMENTATION [V]	FREQUENCE [Hz]	PUIS-SANCE ABSORBÉE [W]	VITESSE DE L'AIR À LA GRILLE [m/s]	DÉBIT D'AIR [m³/h]	NIVEAU DE PUISSANCE ACOUSTIQUE [dB(A)]	ΔT AIR AVEC RÉSISTANCES [°C]	PUIS-SANCE ABSORBÉE AVEC RÉ-SISTANCE DE CHARGE PARTIELLE [W]	PUIS-SANCE ABSORBÉE AVEC RÉ-SISTANCE À PLEINE CHARGE [W]	POIDS [kg]	CONVIENT POUR PORTAILS [mm]
	CODE	STROMVER-SORGUNG [V]	FRE-QUENZ [Hz]	LEI-STUNGS-AUFNAHME [W]	LUFTGE-SCHWIN-DIGKEIT AN DER ÖFFNUNG [m/s]	LUFTDUR-CHFLUSSRA-TE [m³/h]	SCHALLLEI-STUNGSPE-GEL [dB(A)]	ΔT DER LUFT MIT WIDER-STÄNDEN [°C]	LEI-STUNGS-AUFNAHME BEI TEILLASTWIDER-STAND [W]	LEI-STUNGS-AUFNAHME BEI VOLLSTWIDERSTAND [W]	GEWICHT [kg]	GEEIGNET FÜR TÜREN [mm]

CENTRIFUGAL AIR CURTAINS WITH 3 RESISTANCES L: 1000

12450090R2	400 ac	50	180	I:10 II:11,5 III:12,5	I:1288 II:1430 III:1590	I:56 II:59 III:62	19	3800	5700	33	L.1000 H.3500
------------	--------	----	-----	-----------------------------	-------------------------------	-------------------------	----	------	------	----	------------------

CENTRIFUGAL AIR CURTAINS WITH 6 RESISTANCES L: 1500 / 2000

12450100R2	400 ac	50	240	I:10 II:11,5 III:12,5	I:1717 II:1908 III:2120	I:58 II:61 III:64	17	6400	9600	48	L.1500 H.3500
12450110R2	400 ac	50	360	I:10 II:11,5 III:12,5	I:2584 II:2870 III:3190	I:60 II:63 III:66	17	7600	11400	67	L.2000 H.3500

Accessories

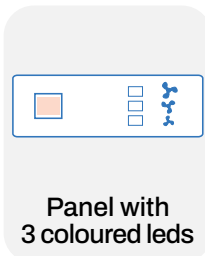

CODE	DESCRIPTION	U.M.	 Pieces per box
12450090R2	"AIRFOR3 CR" CENTRIFUGAL AIR CURTAINS WITH 3 ELECTRIC HEATING ELEMENTS 100	PCS	1
12450100R2	"AIRFOR3 CR" CENTRIFUGAL AIR CURTAINS WITH 6 ELECTRIC HEATING ELEMENTS 1500	PCS	1
12450110R2	"AIRFOR3 CR" CENTRIFUGAL AIR CURTAINS WITH 6 ELECTRIC HEATING ELEMENTS 2000	PCS	1



CENTRIFUGAL AIR CURTAIN WITH FRONT EXTRACTION WITH HOT WATER BATTERY

TECHNICAL SPECIFICATIONS

- 3 models in white with speed controller supplied
- 1/2" water exchanger couplings
- Air curtains are designed for indoor use
- Front air intake
- The unit must be installed horizontally
- Maximum installation height 3 m

RIDEAU D'AIR CENTRIFUGE D'ASPIRATION FRONTALE AVEC BATTERIE A EAU CHAUDE

CARACTÉRISTIQUES TECHNIQUES

- 3 modèles blancs avec régulateur de vitesse fourni
- Raccords d'échangeur de chaleur à eau de 1/2"
- Les barrières à air sont conçues pour une utilisation à l'intérieur
- Aspiration air frontale
- L'unité doit être installée horizontalement
- Hauteur maximale d'installation 3 m

ZENTRIFUGALLUFT MIT FRONTANSAUGUNG MIT WARMWASSERBATTERIE

TECHNISCHE EIGENSCHAFTEN

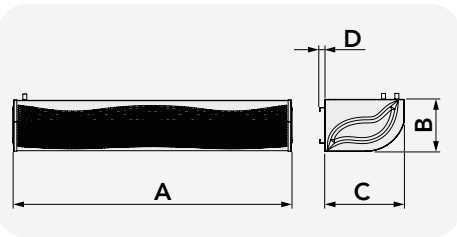

- 3 Modelle in weiße Farbe mit Drehzahlregler im Lieferumfang enthalten
- 1/2" Wasser-Wärmetauscher-Anschlüsse
- Luftschleier sind für die Verwendung in Innenräumen bestimmt
- Frontluftabsaugung
- Das Gerät muss horizontal montiert werden
- Maximale Einbauhöhe 3 m



DIMENSIONS [mm]

MODEL	A	B	C	D
1000	1010	280	425	25
1500	1510	280	425	27
2000	2010	280	425	27



 CODE	SUPPLY VOLTAGE [V]	FREQUENCY [Hz]	POWER CONSUMPTION [W]	AIR SPEED AT INLET [m/s]	AIR FLOW RATE [m³/h]	MEASUREMENT OF IN/OUT CONNECTIONS	AVERAGE WATER TEMPERATURE IN/OUT	HEAT OUTPUT [kW]	AVERAGE WATER FLOW [m³/h]	WEIGHT [kg]	SUITABLE FOR LARGE DOORS [mm]
 CODE	TENSION D'ALIMENTATION [V]	FRÉQUENCE [Hz]	PUISSANCE ABSORBÉE [W]	VITESSE DE L'AIR À LA GRILLE [m/s]	DÉBIT D'AIR [m³/h]	MESURE CONNEXIONS ENTRÉE/SORTIE	TEMPÉRATURE MOYENNE DE L'EAU ENTRÉE/SORTIE	RENDMENT EN PUISSANCE THERMIQUE [kW]	DÉBIT D'EAU MOYEN [m³/h]	POIDS [kg]	CONVIENT POUR PORTAILS [mm]
 CODE	STROMVERSORGUNG [V]	FREQUENZ [Hz]	LEISTUNGSANNAHME [W]	LUFTGESCHWINDIGKEIT AN DER ÖFFNUNG [m/s]	LUFTDURCHFLUSSRADE [m³/h]	ABMESSUNG ANSCHLÜSSE IN/OUT	DURCHSCHNITTliche WASSERTEMPERATUR IN/OUT	THERMISCHE LEISTUNGSABGABE [kW]	MITTLERER WASSERDURCHSATZ [m³/h]	GEWICHT [kg]	GEEIGNET FÜR TÜREN [mm]
12450090	230 ac	50	192	13	1590	1/2"	70°C/60°C	11.4	1	31,9	L.1000 H.3000
12450100	230 ac	50	256	13	2120	1/2"	70°C/60°C	16.1	1,42	45,1	L.1500 H.3000
12450110	230 ac	50	384	13	3190	1/2"	70°C/60°C	24.1	2,12	64	L.2000 H.3000

Accessories



CODE	DESCRIPTION	U.M.	 Pieces per box
12450090	"AIRFOR3 H2O" CENTRIFUGAL AIR CURTAINS WITH WATER BATTERY 1000	PCS	1
12450100	"AIRFOR3 H2O" CENTRIFUGAL AIR CURTAINS WITH WATER BATTERY 1500	PCS	1
12450110	"AIRFOR3 H2O" CENTRIFUGAL AIR CURTAINS WITH WATER BATTERY 2000	PCS	1





BUILT-IN CENTRIFUGAL AIR CURTAIN AT ROOM TEMPERATURE

TECHNICAL SPECIFICATIONS

- 3 models in white
- With speed controller supplied
- Air curtains are designed for indoor use
- Flow adjustment via flaps
- Total integration in the false ceiling
- The unit must be installed horizontally
- Installation height max 3.5 m

RIDEAU D'AIR CENTRIFUGE INTÉGRÉ À TEMPÉRATURE AMBIANTE

CARACTÉRISTIQUES TECHNIQUES

- 3 modèles blancs
- Avec régulateur de vitesse inclus
- Les barrières à air sont conçues pour une utilisation à l'intérieur
- Réglages du débit via l'ailette
- Intégration totale dans le faux plafond
- L'unité doit être installée horizontalement
- Hauteur d'installation max. 3,5 m

EINGEBAUTE ZENTRIFUGALLUFT BEI RAUMTEMPERATUR

TECHNISCHE EIGENSCHAFTEN

- 3 Modelle in weiße Farbe
- Mit mitgeliefertem Drehzahlregler
- Luftschleier sind für die Verwendung in Innenräumen bestimmt
- Durchflussverstellung über Rippe
- Vollständige Integration in der Zwischendecke
- Das Gerät muss horizontal installiert werden
- Einbauhöhe max. 3,5 m

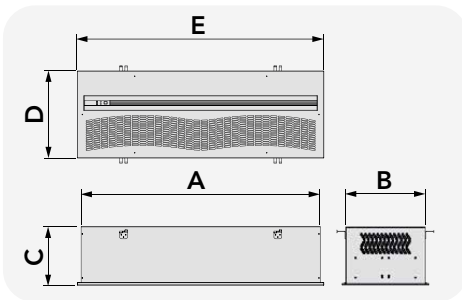



DIMENSIONS [mm]

MODEL	A	B	C	D	E
1000	1000	362	270	396	1034
1500	1500	362	270	396	1524
2000	2000	362	270	396	2034



 AT ROOM TEMPERATURE

 CODE	SUPPLY VOLTAGE [V]	FREQUENCY [Hz]	POWER CONSUMPTION [W]	AIR SPEED AT INLET [m/s]	AIR FLOW RATE [m³/h]	SOUND POWER LEVEL [dB(A)]	WEIGHT [kg]	SUITABLE FOR LARGE DOORS [mm]
 CODE	TENSION D'ALIMENTATION [V]	FRÉQUENCE [Hz]	PUISSANCE ABSORBÉE [W]	VITESSE DE L'AIR À LA GRILLE [m/s]	DÉBIT D'AIR [m³/h]	NIVEAU DE PUISSANCE ACOUSTIQUE [dB(A)]	POIDS [kg]	CONVIENT POUR PORTAILS [mm]
 CODE	STROMVERSORGUNG [V]	FREQUENZ [Hz]	LEISTUNGSANNAHME [W]	LUFTGESCHWINDIGKEIT AN DER ÖFFNUNG [m/s]	LUFTDURCHFLOSSRATE [m³/h]	SCHALLLEISTUNGSPEGEL [dB(A)]	GEWICHT [kg]	GEEIGNET FÜR TÜREN [mm]
12300033	230 ac	50	225	12	1436	60	22	L.1000 H MAX.3500 H MIN.1800
12300035	230 ac	50	300	12	2129	61	33	L.1500 H MAX.3500 H MIN.1800
12450030	230 ac	50	450	12	3197	62	47	L.2000 H MAX.3500 H MIN.1800

Accessories



CODE	DESCRIPTION	U.M.	 Pieces per box
12300033	"ARIA2 ELEGANCE" 1000 BUILT-IN AIR CURTAINS	PCS	1
12300035	"ARIA2 ELEGANCE" 1500 BUILT-IN AIR CURTAINS	PCS	1
12450030	"ARIA2 ELEGANCE" 2000 BUILT-IN AIR CURTAINS	PCS	1



ARIA 2 ELEGANCE CR



BUILT-IN CENTRIFUGAL AIR CURTAIN WITH ELECTRICAL HEATING ELEMENT

TECHNICAL SPECIFICATIONS

- 3 models in white
- 3 speeds operated by remote control
- Air curtains are designed for indoor use
- Automatic start-up kit on request
- Total integration in the false ceiling
- The unit must be installed horizontally
- Installation height max 3 m

RIDEAU D'AIR CENTRIFUGE À ASPIRATION INTÉGRÉ AVEC RÉSISTANCE ÉLECTRIQUE

CARACTÉRISTIQUES TECHNIQUES

- 3 modèles blancs
- 3 vitesses commandées par télécommande
- Les barrières à air sont conçues pour une utilisation à l'intérieur
- Kit de démarrage automatique sur demande
- Intégration totale dans le faux plafond
- L'unité doit être installée horizontalement
- Hauteur d'installation max. 3 m

EINGEBAUTE ZENTRIFUGALLUFT MIT ELEKTRISCHEM HEIZKÖRPER

TECHNISCHE EIGENSCHAFTEN

- 3 Modelle in weiße Farbe
- 3 Geschwindigkeiten, mit Fernbedienung betrieben
- Luftschleier sind für die Verwendung in Innenräumen bestimmt
- Automatisches Anlaufset auf Anfrage
- Vollständige Integration in der Zwischendecke
- Das Gerät muss horizontal montiert werden
- Einbauhöhe max. 3 m

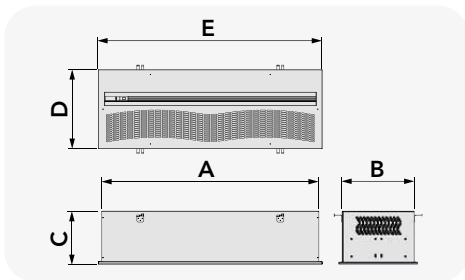

DIMENSIONS [mm]					
MODEL	A	B	C	D	E
1000	1000	362	270	396	1034
1500	1500	362	270	396	1524
2000	2000	362	270	396	2034

WITH ELETRIC RESISTANCE

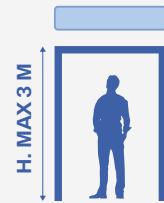

UK CODE	SUPPLY VOLTAGE [V]	FREQUENCY [Hz]	POWER CONSUMPTION [W]	AIR SPEED AT INLET [m/s]	POWER CONSUMPTION WITH PARTIAL LOAD RESISTANCE [W]	POWER ABSORBED WITH FULL LOAD RESISTANCE [W]	AIR FLOW RATE [m³/h]	SOUND POWER LEVEL [dB(A)]	ΔT AIR WITH HEATING ELEMENTS [°C]	WEIGHT [kg]	SUITABLE FOR LARGE DOORS [mm]
FR CODE	TENSION D'ALIMENTATION [V]	FRÉQUENCE [Hz]	PUISSANCE ABSORBÉE [W]	VITESSE DE L'AIR À LA GRILLE [m/s]	PUISSANCE ABSORBÉE AVEC RÉSISTANCE DE CHARGE PARTIELLE [W]	PUISSANCE ABSORBÉE AVEC RÉSISTANCE À PLEINE CHARGE [W]	DÉBIT D'AIR [m³/h]	NIVEAU DE PUISSANCE ACOUSTIQUE [dB(A)]	ΔT AIR AVEC RÉSISTANCES [°C]	POIDS [kg]	CONVIENT POUR PORTAILS [mm]
DE CODE	STROMVERSORGUNG [V]	FREQUENZ [Hz]	LEISTUNGS-AUFNAHME [W]	LUFTGESCHWINDIGKEIT AN DER ÖFFNUNG [m/s]	LEISTUNGS-AUFNAHME BEI TEILLASTWIDERSTAND [W]	LEISTUNGS-AUFNAHME BEI VOLLSTANDWIDERSTAND [W]	LUFTDURCHFLUSSRA-TE [m³/h]	SCHALLLEISTUNGSPE- GEL [dB(A)]	ΔT DER LUFT MIT WIDERSTÄNDEN [°C]	GEWICHT [kg]	GEEIGNET FÜR TÜREN [mm]
CENTRIFUGAL AIR CURTAINS WITH 3 ELECTRIC RESISTANCES											
12300033R3	400 ac	50	180	I:1163 II:1242 III:1436	3800	5700	I:1163 II:1242 III:1436	I:54 II:57 III:60	20	23	L.1000 HMAX.3000 HMIN.1800
CENTRIFUGAL AIR CURTAINS WITH 6 ELECTRIC RESISTANCES											
12300035R3	400 ac	50	240	I:1163 II:1242 III:1436	6400	9600	I:1724 II:1916 III:2129	I:55 II:58 III:61	20	36	L.1500 HMAX.3000 HMIN.1800
12450030R3	400 ac	50	360	I:1163 II:1242 III:1436	7600	11400	I:2589 II:2877 III:3197	I:56 II:59 III:62	20	50	L.2000 HMAX.3000 HMIN.1800

Accessories

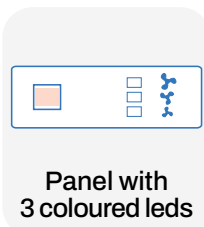

CODE	DESCRIPTION	U.M.	Pieces per box
12300033R3	"ARIA2 ELEGANCE CR" 1000 CENTRIFUGAL AIR CURTAINS WITH 3 ELECTRIC HEATING ELEMENTS	PCS	1
12300035R3	"ARIA2 ELEGANCE CR" 1500 CENTRIFUGAL AIR CURTAINS WITH 6 ELECTRIC HEATING ELEMENTS	PCS	1
12450030R3	"ARIA2 ELEGANCE CR" 2000 CENTRIFUGAL AIR CURTAINS WITH 6 ELECTRIC HEATING ELEMENTS	PCS	1



ARIA 2 ELEGANCE H2O

BUILT-IN CENTRIFUGAL AIR CURTAIN WITH HOT WATER BATTERY

TECHNICAL SPECIFICATIONS

- 3 models in white
- 3 speeds operated by remote control
- Air curtains are designed for indoor use
- Total integration in the false ceiling
- The unit must be installed horizontally
- Installation height max. 3 m

RIDEAU D'AIR CENTRIFUGE INTÉGRÉ AVEC SERPENTIN D'EAU CHAUDE

CARACTÉRISTIQUES TECHNIQUES

- 3 modèles blancs
- 3 vitesses commandées par télécommande
- Les barrières à air sont conçues pour une utilisation à l'intérieur
- Intégration totale dans le faux plafond
- L'unité doit être installée horizontalement
- Hauteur d'installation max. 3 m

ZENTRIFUGALLUFT FÜR DEN EINBAU MIT WARMWASSERBATTERIE

TECHNISCHE EIGENSCHAFTEN

- 3 Modelle in weiße Farbe
- 3 Geschwindigkeiten, mit Fernbedienung betrieben
- Luftschleier sind für die Verwendung in Innenräumen bestimmt
- Vollständige Integration in der Zwischendecke
- Das Gerät muss horizontal montiert werden
- Einbauhöhe max. 3 m

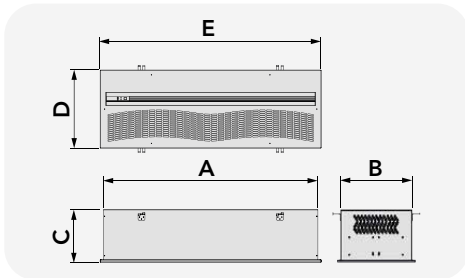

DIMENSIONS [mm]

MODEL	A	B	C	D	E
1000	1000	362	331	396	1034
1500	1500	362	331	396	1524
2000	2000	362	331	396	2034

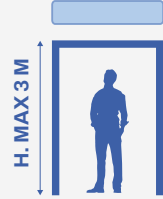

CODE	SUPPLY VOLTAGE [V]	FREQUENCY [Hz]	POWER CONSUMPTION [W]	AIR SPEED AT INLET [m/s]	AIR FLOW RATE [m³/h]	SOUND POWER LEVEL [dB(A)]	MEASUREMENT OF IN/OUT CONNECTIONS	AVERAGE TEMPERATURE IN/OUT [°C]	HEAT OUTPUT [kW]	AVERAGE WATER FLOW [m³/h]	WEIGHT [kg]	SUITABLE FOR LARGE DOORS [mm]
12450092	230	50	180	I:8 II:10 III:12	1590	62	1/2"	70/60	11,4	1	31,9	L1000 H3000
12450102	230	50	240	I:8 II:10 III:12	2120	64	1/2"	70/60	16,1	1,42	45,1	L1500 H3000
12450112	230	50	360	I:8 II:10 III:12	3190	66	1/2"	70/60	24,1	2,12	64	L2000 H3000

Accessories

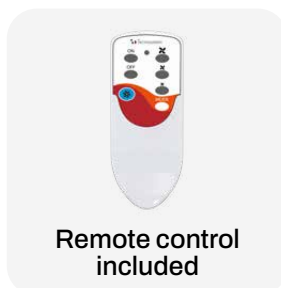

CODE	DESCRIPTION	U.M.	Pieces per box
12450092	"ARIA2 ELEGANCE H2O" 1000 CENTRIFUGAL AIR CURTAINS WITH HOT WATER COIL	PCS	1
12450102	"ARIA2 ELEGANCE H2O" 1500 CENTRIFUGAL AIR CURTAINS WITH HOT WATER COIL	PCS	1
12450112	"ARIA2 ELEGANCE H2O" 2000 CENTRIFUGAL AIR CURTAINS WITH HOT WATER COIL	PCS	1



INDUSTRIAL CENTRIFUGAL AIR CURTAIN LARGE FLOW RATES WITH FRONT EXTRACTION

This high-performance air curtain uses three-phase motors to provide maximum airflow. Its performance allows installations up to heights of 5 m, creating actual barriers on large gates, such as industrial gates, leaving free the manoeuvring passage of persons or vehicles. The unit can be placed on the ceiling and must be installed horizontally.

RIDEAU D'AIR CENTRIFUGE INDUSTRIELLE À GRAND DÉBIT AVEC ASPIRATION FRONTALE

Cette barrière à air haute performance utilise des moteurs triphasés pour fournir un débit d'air maximal. Ses performances permettent des installations jusqu'à des hauteurs de 5 m, créant de véritables barrières sur les grandes portes, telles que les portes industrielles, laissant libre le passage des personnes ou des véhicules en manœuvre. L'appareil peut être placé au plafond et doit être installé horizontalement.

INDUSTRIELLE ZENTRIFUGAL-LUFT GROSSE DURCHFLUSSMENGEN MIT FRONTABSUGUNG

Diese Hochleistungs-Luftschleier verwendet Drehstrommotoren, um einen maximalen Luftstrom zu gewährleisten. Seine Leistung ermöglicht Installationen bis zu einer Höhe von 5 m, wodurch echte Sperren an großen Toren, wie Industrietoren, entstehen, die den Durchgang von Personen oder Fahrzeugen im Manöver freilassen. Das Gerät kann an der Decke angebracht werden und muss waagrecht installiert werden.

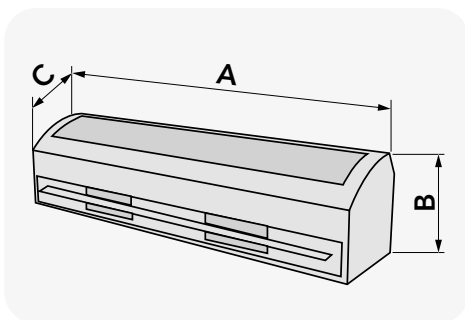

DIMENSIONS [mm]			
MODEL	A	B	C
1000	1000	287	297
1500	1500	287	297



CODE	SUPPLY VOLTAGE [V]	FREQUENCY [Hz]	POWER CONSUMPTION [W]	AIR SPEED AT INLET [m/s]	AIR FLOW RATE [m³/h]	SOUND POWER LEVEL [dB(A)]	WEIGHT [kg]	FOR DOORS WITH DIMENSIONS [mm]
CODE	TENSION D'ALIMENTATION [V]	FRÉQUENCE [Hz]	PUISSANCE ABSORBÉE [W]	VITESSE DE L'AIR À LA GRILLE [m/s]	DÉBIT D'AIR [m³/h]	NIVEAU DE PUISSANCE ACOUSTIQUE [dB(A)]	POIDS [kg]	POUR PORTES DE DIMENSIONS [mm]
CODE	STROMVERSOR-GUNG [V]	FREQUENZ [Hz]	LEISTUNGS-AUFNAHME [W]	LUFTGESCHWIN-DIGKEIT AN DER ÖFFNUNG [m/s]	LUFTDUR-CHFLUSSRATE [m³/h]	SCHALLELEISTUNGSPE-GEL [dB(A)]	GEWICHT [kg]	FÜR TÜREN MIT ABMESSUNGEN [mm]
12300042	380 ac	50	1100	28	3709	64	32,7	H. MIN.3000 H. MAX.5000
AAC400001	380 ac	50	1850	28	5563	68	52	H. MIN. 3000 H.MAX. 5000

Accessories



CODE	DESCRIPTION	U.M.	Pieces per box
12300042	"ARIA 1 POTENZA" HIGH-CAPACITY INDUSTRIAL AIR CURTAINS 100	PCS	1
AAC400001	HIGH PERFORMING AIR CURTAINS WITH FORNT AIR INTAKE "ARIA1 POTENZA" 1500	PCS	1



AUTOMATIC START KIT FOR AIR CURTAINS.

TECHNICAL SPECIFICATIONS

The kit can be used in the following models of air curtains:

- Airjet
- Aria 3 silence (with resistance) *
- Aria 3 silence front
- Aria 2 elegance T
- Aria 2 elegance TR *
- Aria 2 elegance CR *
- Air for 3 CR *

KIT DÉMARRAGE AUTOMATIQUE POUR RIDEAUX D'AIR

CARACTÉRISTIQUES TECHNIQUES

Le kit peut être utilisé dans les modèles de barrières d'air suivants :

- Airjet
- Aria 3 silence (avec résistance) *
- Aria 3 silence front
- Aria 2 elegance T
- Aria 2 elegance TR *
- Aria 2 elegance CR *
- Air for 3 CR *

AUTOMATISCHER STARTSATZ FÜR LUFTBARRIEREN

TECHNISCHE EIGENSCHAFTEN

Der Bausatz kann mit den folgenden Modellen von Luftbarrieren verwendet werden:

- Airjet
- Aria 3 silence (mit heizkörper) *
- Aria 3 silence front
- Aria 2 elegance T
- Aria 2 elegance TR *
- Aria 2 elegance CR *
- Air for 3 CR *



* For the built-in models "Aria2 Elegance TR", "Aria2 Elegance CR" and "Aria3Silence" (with heating element) pay attention to the installation methods of the automatic starter kit illustrated in the user manual.

CODE	DESCRIPTION	U.M.	 Pieces per box
12300058	AUTOMATIC START KIT FOR AIR CURTAINS	PCS	1



CEILING WALL BRACKET FOR AIR CURTAINS

SUPPORT AU PLAFOND POUR RIDEAUX D'AIR

DECKENKONSOLE FÜR LUFTBARRIEREN



DIMENSIONS [mm]			
A	B	H.MIN.	H.MAX.
120	45	450	770

CODE	DESCRIPTION	U.M.	 Pieces per box
12300057	BRACKETS FOR AIR CURTAINS	PCS	1

220V SINGLE PHASE SPEED REGULATOR

The electronic speed regulator makes it possible to vary the air flow of the heat recovery element and of the barrier from 30% to 100% of its performance.

RÉGULATEUR DE VITESSE MONOPHASÉ 220 V

Le régulateur de vitesse électronique permet de faire varier le débit d'air de l'unité de récupération de chaleur et de la barrière de 30% à 100% de ses performances.

DREHZAHLEGLER 220V EINPHASEN

Mit dem elektronischen Drehzahlregler können Sie den Luftstrom der Wärmerückgewinnungseinheit und der Barriere von 30 % bis 100 % ihrer Leistung variieren.

CODE	DESCRIPTION	U.M.	 Pieces per box
12300100	SINGLE-PHASE 220V SPEED CONTROL MODEL 200 - 300 - 400 - 600	PCS	1
12300105	SINGLE-PHASE 220V SPEED CONTROL MODEL 800	PCS	1
12300110	SINGLE-PHASE 220V SPEED CONTROL MODEL 1000-1300	PCS	1
12300115	SINGLE-PHASE 220V SPEED CONTROL MODEL 1600-2100	PCS	1
12300120	SINGLE-PHASE 220V SPEED CONTROL MODEL 2500-3000	PCS	1





Apply Air

Air Curtains and Accessories

INDEX CATALOGUE 39

CODE	PAGE	CODE	PAGE
12300033	39	12450070	35
12300033R3	40	12450090	37
12300035	39	12450090R2	36
12300035R3	40	12450092	41
12300036	34	12450100	37
12300037	34	12450100R2	36
12300038	32	12450102	41
12300039	32	12450110	37
12300042	42	12450110R2	36
12300044	33	12450112	41
123000445	33	AAC100001	33
12300050I	16	AAC200001	23
12300050RI	18	AAC200002	23
12300050RI2	19	AAC400001	42
12300051I	16	AAD200001	22
12300051RI	18	AAD200002	22
12300051RI2	19	AAD200003	22
12300055I	16	AAD400001	31
12300055RI	18	AAD400002	31
12300055RI2	19	AAD400003	31
12300056I	16	AAD400004	31
12300056RI	18		
12300056RI2	19	New Products	
12300057	43		
12300058	43		
12300100	43		
12300105	43		
12300110	43		
12300115	43		
12300120	43		
12400011	21		
12400013	21		
12400021	21		
12400031	21		
12450014	25		
12450014R2	27		
12450014R3	27		
12450024	25		
12450024R2	27		
12450024R3	27		
12450030	39		
12450030R3	40		
12450034	25		
12450034R2	27		
12450034R3	27		
12450050	35		
12450060	35		