

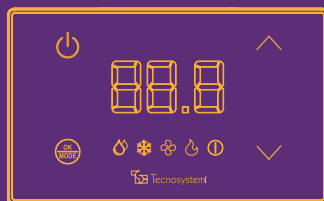

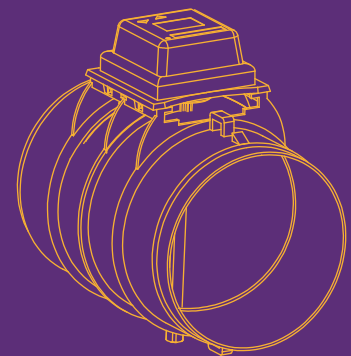

Galaxy

Multi-Zone Air Control System

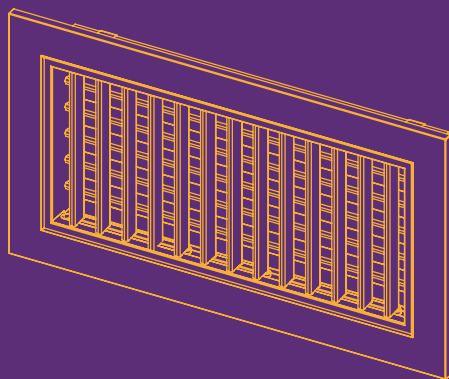
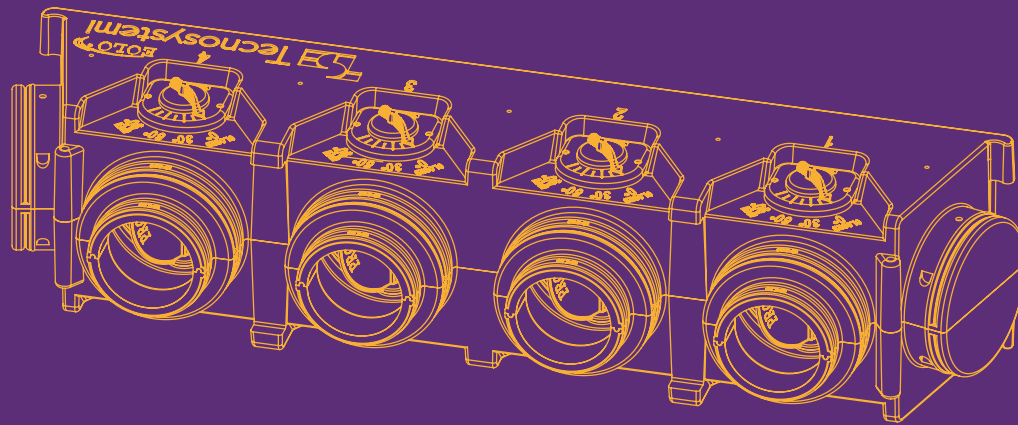

Managing temperatures in homes and offices has never been so easy: as of today, ProAir Multi-Zone, the **Multizone Management System** entirely designed and built by **Tecnosystemi S.p.A.**, is finally available. Communication with the control unit via RF radio frequency or wired programmable thermostats guarantees reliability and precision to your system.

The innovative and practical **APP** both for **Android** or **IOS** operating system allows remote adjustment of each single room by controlling up to 20 systems.

PRODUCT INDEX

10

Control unit with communication protocols, apps, Alexa and Google Home "POLARIS 5X"



14

Wall mounted, programmable thermostat, battery-powered, digital, radio frequency "DISCOVERY 3X"



15

Wall mounted, programmable thermostat, battery-powered, digital, radio frequency "MINI-LED ASTRA"



17

Wall-mounted room probe, battery powered, "LEM 3X RF" radiofrequency



18

Built-in, programmable thermostat wired, digital "STEALTH 3X"



19

Motorised dampers and grilles , relay module for radiant and fan coil systems, window contact and connection cables. Bypass of overpressure



29

How to choose your system
How to choose the right proair pack for you



31

Proair pack RF 2 with eolo plenum
Proair pack RF 2L with insulated metal plenum



33

Proair pack RF 3 Eolo / Eolo mini
Proair pack RF 3L
with insulated metal plenum



35

Proair pack RF 4 Eolo / Eolo mini
Proair pack RF 4L
with insulated metal plenum



37

Proair pack RF 5 Eolo
Proair pack RF 5L
with insulated metal plenum



39

Proair pack RF 6 Eolo
Proair pack RF 6L
with insulated metal plenum



43

Proair pack CAB 2 Eolo
Proair pack CAB 2L
with insulated metal plenum



44

Proair pack CAB 3 Eolo/ Eolo mini
Proair pack CAB 3L
with insulated metal plenum



45

Proair pack CAB 4 Eolo / Eolo mini
Proair pack CAB 4L
with insulated metal plenum

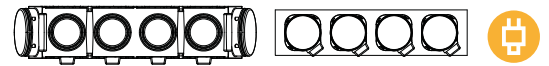

46

Proair pack CAB 5 Eolo
Proair pack CAB 5L
with insulated metal plenum
Proair pack CAB 6L with insulated metal plenum



48

Custom-made insulated plenums
for ducted units in polystyrene
insulated metal sheet and in PAL



50

"Kit rapid" to complete the proair pack
system for the distribution or the air.

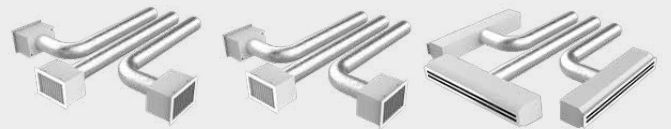

70

Punctual management with motorised
damper and gilles "ALTAIR POINT"



74

Punctual management with motorised
damper "SIRIO 2.0 POINT".
Punctual management "SIRIO 0.10V"



78

Punctual management
"SIRIO 2.0 PACK POINT".
Punctual management
"SIRIO 0.10V PACK"



82

Punctual management with "T" flow diverter
and with motorised damper "SIRIO 3.0 DEVIO POINT"



84

Punctual management with motorised
butterfly damper "SIRIO POINT"



86

Punctual management with motorised
delivery grilles and infrared remote
control for punctual systems "VEGA POINT"



90

"STAR POINT" punctual management
with motorised delivery grilles complete
with plenum. For low head ducted unit





THE IDEAL CLIMATE WHEREVER YOU WANT!

Personalized comfort and optimized energy consumption with ProAir Multizone

Zoning and indoor temperature control systems make it possible to increase living comfort while keeping energy consumption under control. ProAir Multizone is the zoning system designed and developed by Tecnosystemi, which manufactures the components required to install a ducted air conditioning system.

It is a true temperature management system that allows precise control in each room of a home or commercial environment. It can manage the ducted unit and the motorized bypass where necessary, even remotely via an app on a smartphone or tablet.

The zones are independent and controlled by programmable thermostats that constantly monitor the temperature. Thanks to the electronic control unit connected to the motorized dampers, the system is able to achieve the ideal climate for every specific need.



Tecnosystemi

Free App available on
App Store and Google Play

EXAMPLE OF PROAIR SYSTEM APPLICATION

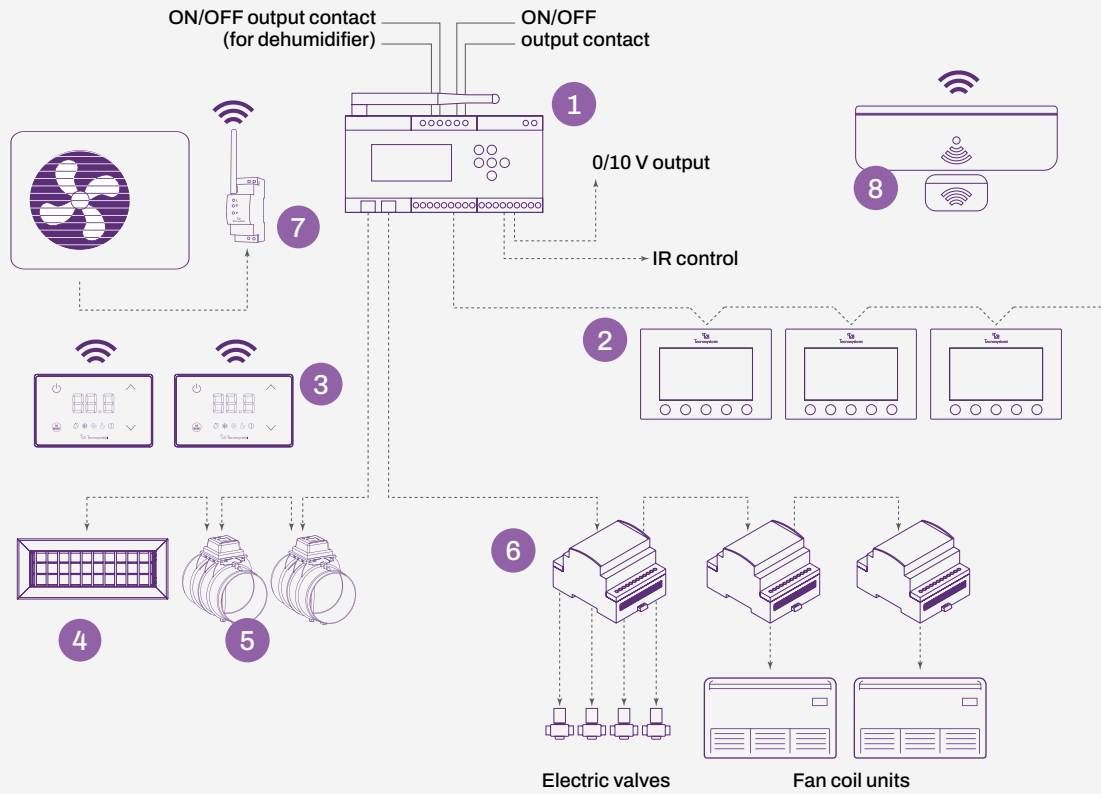

- 1 Control Unit Polaris 5X
- 2 Thermostat
- 3 Mini-led Astra
- 4 ProAir Multizone Grille
- 5 Motorised damper
- 6 Relay Module
- 7 Consumption meter
- 8 Window contact in radio frequency

PLUS OF THE PROAIR ZONING CONTROL SYSTEM

Energy saving

Total design and integration

Plug and Play Solution

Consumption Accounts

Radiant floor control for heating, cooling and fan coils

Programming from App and control via smart speakers such as Alexa and Google Home

Possibility to set the desired temperature in every single room

Control unit with color display, with communication protocols dedicated to the main brands of air conditioners

TRADITIONAL DUCTED SYSTEM

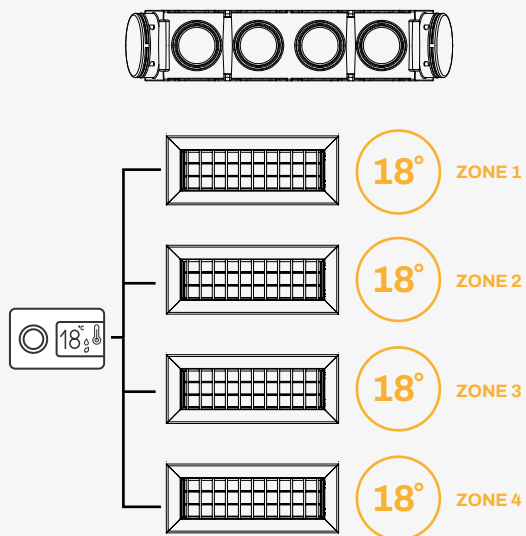

Regulation of the same temperature for all rooms via the remote control or the wire thermostat supplied.

DUCTED SYSTEM WITH DIFFERENTIATED TEMPERATURE MANAGEMENT

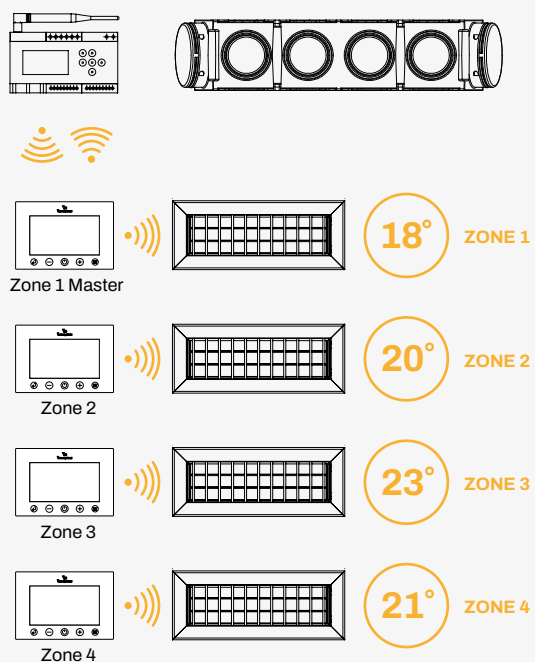

SINGLE CONTROL UNIT WITH COLOUR DISPLAY, COMMUNICATION PROTOCOLS AND ALEXA APP - GOOGLE HOME

TECHNICAL SPECIFICATIONS

- Interface: 2.5" LCD display and keypad
- Wired zone thermostat management
- Radio zone thermostat management
- Zone actuator management
- Communication with radio frequency zone thermostats
- ON/OFF direct expansion ducted management
- 3 Speed direct expansion ducted management
- Direct expansion ducted management via IR (30 integrated protocols)
- Ducted management via 0/10V
- Dehumidification system ON/off control in floor cooling feature
- Control via local or remote WiFi 2.4Ghz via dedicated App and voice assistants
- Digital input for alarm management
- Updating the controller
- Management of up to 16 zones - 32 Actuators
- Ventilation By-Pass control

UNITÉ DE CONTRÔLE UNIQUE AVEC AFFICHAGE COULEUR, PROTOCOLES DE COMMUNICATION ET APPLICATION ALEXA - GOOGLE HOME

CARACTÉRISTIQUES TECHNIQUES

- Interface : Écran LCD 2,5" et clavier
- Gestion de thermostats de zone câblés
- Gestion de thermostats de zone radio
- Gestion des actionneurs de zone
- Communication avec des thermostats de zone en fréquence radio
- Gestion canalisée détente directe ON/OFF
- Gestion canalisée détente directe 3 Vitesses
- Gestion canalisée détente directe via IR (30 protocoles intégrés)
- Gestion canalisée via 0/10 V
- Contrôle ON/OFF du système de déshumidification en fonction du refroidissement au sol
- Contrôle via Wi-Fi local ou à distance 2,4 GHz en utilisant l'application dédiée et des assistants vocaux
- Entrée numérique pour la gestion des alarmes
- Mise à jour de L'unité de commande
- Gestion jusqu'à 16 zones - 32 actionneurs
- Contrôle By-pass ventilation

POLARIS 5X (WLAN) IN-ZELSTEUERGERÄT MIT FARBDISPLAY, KOMMUNIKATIONSPROTOKOLLEN UND ALEXA-APP - GOOGLE HOME

TECHNISCHE EIGENSCHAFTEN

- Schnittstelle: 2,5-Zoll-LCD-Display und Tastatur
- Steuerung der verdrahteten Zonethermostate
- Steuerung der Zonen-Funkthermostate
- Steuerung der Zonen-Stellantriebe
- Kommunikation mit Zonethermostaten im Funkfrequenzbereich
- Kanalisierte Steuerung mit Direktverdampfung ON/OFF
- Kanalisierte Steuerung mit Direktverdampfung 3 Geschwindigkeiten
- Kanalisierte Steuerung mit Direktverdampfung über IR (30 integrierte Protokolle)
- Kanalisierte Steuerung über 0/10V
- Steuerung ON/OFF des Entfeuchtungssystems im Modus Bodenkühlung
- Steuerung über lokales WLAN oder 2.4Ghz-Fernsteuerung über entsprechende App und Sprachassistenten
- Digitaleingang für Alarmmanagement
- Aktualisierung der Steuereinheit
- Steuerung von bis zu 16 Zonen - 32 Stellantrieben
- Kontrolle des Belüftungs-Bypasses

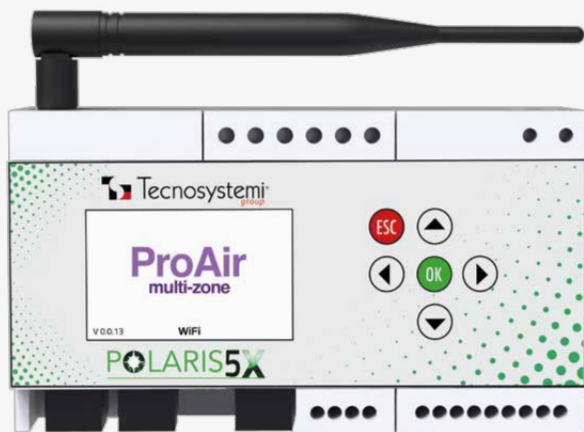

Voice commands available for Alexa and Google Home



With colour display

Over 30 integrated communication protocols



VIRTUAL REALITY



DATASHEET

CODE	DESCRIPTION	U.M.	Pieces per box
GAD100012	CONTROL UNIT WITH COMMUNICATION PROTOCOLS, APP - ALEXA GOOGLE HOME "POLARIS 5X" WI-FI	PCS	1

COMMUNICATION PROTOCOLS FOR CONTROL UNIT

TECHNICAL SPECIFICATIONS

Communication protocols are installed in the Polaris 5X control units to send the main settings to the ducted unit, without using the supplied remote control. In this way, the customer can define, in a single action, the operating modes of both the ducted unit and the ProAir system directly from the master programmable thermostat (Discovery 3X or Stealth 3X) or from the App ProAir Multizone.

Attention: Make sure that the ducted machine provides the infra-red receiver.

Make sure the protocol is available in the control unit.

The protocols dedicated to the main commercially available air conditioning units allow assigning the following functions, depending on the type of ducted unit:

- On / off of ducted unit
- Operating mode: warm - cold - ventilation - dehumidification
- Hot and cold set point
- Fan speed management

Attention! The aforementioned modes may vary according to the model of the ducted unit that has been installed. Using the control unit models 5X complete with communication protocols does not entail the purchase of the interface for on-off remote control.

PROTOCOLES DE COMMUNICATION POUR UNITÉ DE CONTROL

CARACTÉRISTIQUES TECHNIQUES

Les protocoles de communication sont installés dans l'unité de commande Polaris 5X, qui peut envoyer les principaux réglages à l'unité canalisée, sans utiliser la télécommande fournie. De cette façon, le client pourra définir en une seule action les modes de fonctionnement, tant de l'unité canalisée que du système ProAir, directement à partir du thermostat programmable principal (Discovery 3X ou Stealth 3X ou à partir de l'application ProAir Multizone).

Assurez-vous que le protocole est présent dans la centrale.

Selon le type de modèle d'unité canalisée, les protocoles dédiés des principales marques de climatiseurs du marché permettent d'affecter les fonctions suivantes :

- Marche / arrêt de l'unité canalisée
- Modalités de fonctionnement : chaud - froid - ventilation - déshumidification
- Point de consigne chaud et froid
- Gestion de la vitesse du ventilateur

Attention ! Les modalités énoncées ci-dessus peuvent varier selon le modèle de l'unité canalisée installée. L'utilisation de l'unité de commande Polaris 5X complète avec le protocole de communication n'implique pas l'achat de l'interface pour la commande marche-arrêt à distance.

POLARIS 5X (WLAN) IN-ZELSTEUERGERÄT MIT FARBDISPLAY, KOMMUNIKATIONS-PROTOKOLLEN UND ALEXA-APP - GOOGLE HOME

TECHNISCHE EIGENSCHAFTEN

Die Kommunikationsprotokolle, die die wichtigsten Einstellungen an die kanalisierte Einheit senden können, ohne die mitgelieferte Fernbedienung zu verwenden, sind in den Steuergeräten Polaris 5X installiert. Auf diese Weise kann der Kunde die Betriebsarten sowohl des kanalisierten Geräts als auch des ProAir-Systems in einer einzigen Handhabung direkt am Master-Chronothermostat (Discovery 3X oder Stealth 3X oder ProAir Multizone App) definieren.

Stellen Sie sicher, dass das Protokoll in der Steuereinheit vorhanden ist.

Abhängig vom Typ des kanalisierten Gerätemodells erlauben die speziellen **Protokolle der wichtigsten Klimagerätemarken auf dem Markt die Zuordnung der folgenden Funktionen:**

- Ein/Aus der Kanaleinheit
- Betriebsmodus: warm - kalt - Belüftung - Entfeuchtung
- Sollwert beim Kühlen und Heizen
- Verwaltung der Lüfterdrehzahl

Achtung! Die oben genannten Modi können abhängig vom Modell des installierten kanalisierten Geräts variieren. Die Verwendung der Polaris 5X-Steuereinheit einschließlich Kommunikationsprotokoll bedeutet nicht den Kauf der Schnittstelle für die Ein-Aus-Fernbedienung.



DAIKIN

SAMSUNG

PANASONIC

TOSHIBA

Haier

FUJITSU

GREE

Fuji Electric

Hisense

LG

MITSUBISHI HEAVY INDUSTRIES, LTD.

HITACHI

parkair energy solutions

VIESSMANN

AERMEC

GENERAL

ARGO

CLIVET

STORM

SABIANA

tekno point

fiorini

IDEMA

MIDEA

SINCLAIR AIR CONDITIONING

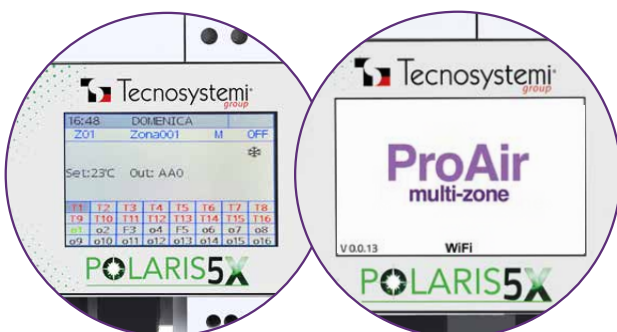

Only available for machines supplied with remote control

WITH THE POLARIS CONTROL UNIT YOU CAN MANAGE THE SYSTEM WITH ALEXA AND GOOGLE HOME



SETS 20°
IN THE KITCHEN

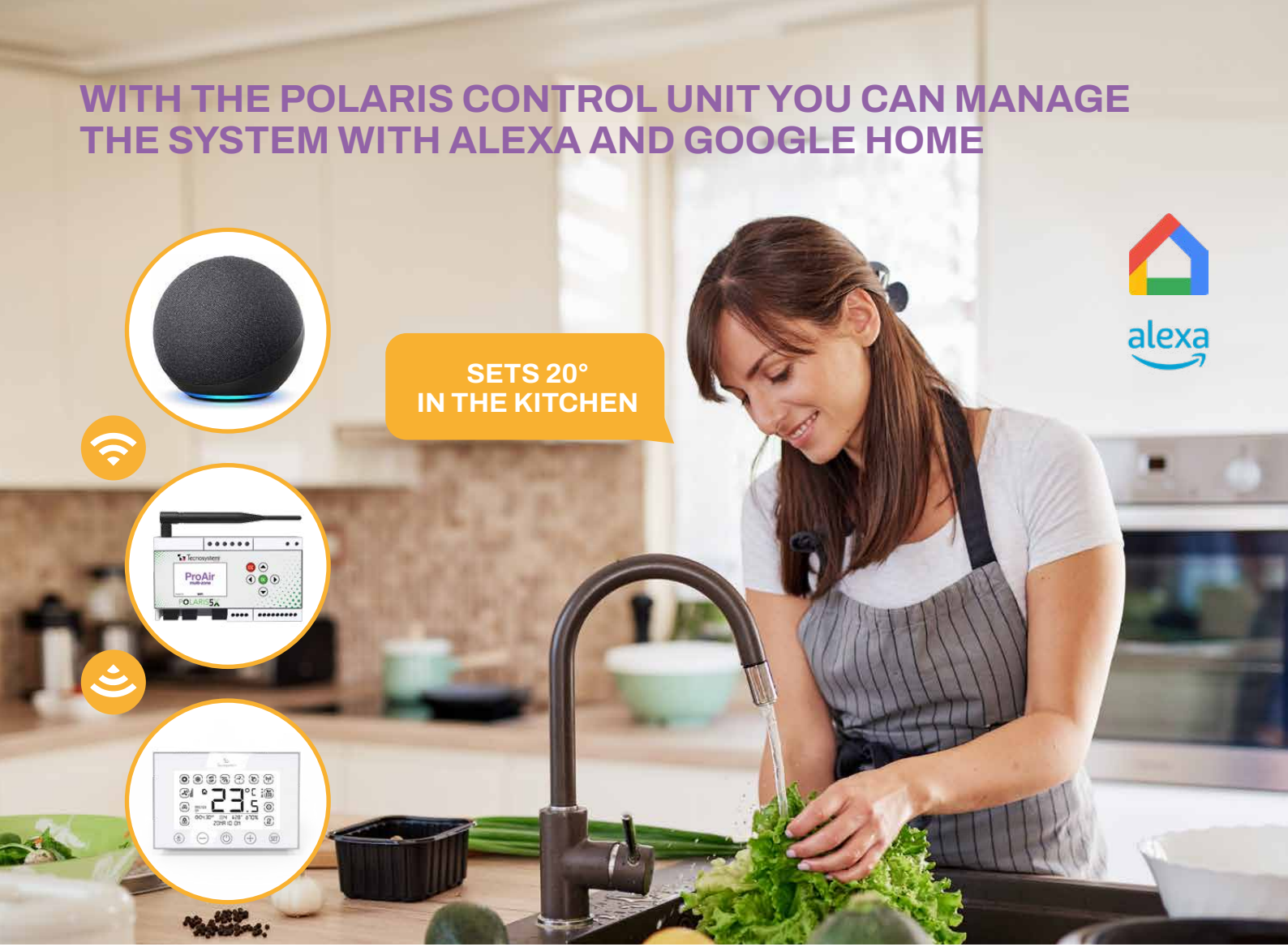

USE THE APP "PROAIR MULTI - ZONE CONTROL SYSTEM" TO CONTROL UP TO 20 UNITS AT ANY TIME, IN ANY PLACE!

To access the control unit functions **use the Tecnosystemi multi-zone control system app**, with which you can monitor and run your system in real time by means of a remote control. Whether you're at home, in the office or travelling, you can remotely control your air conditioning units in a simple, practical way.

Controlling your home's air conditioning is now even easier!

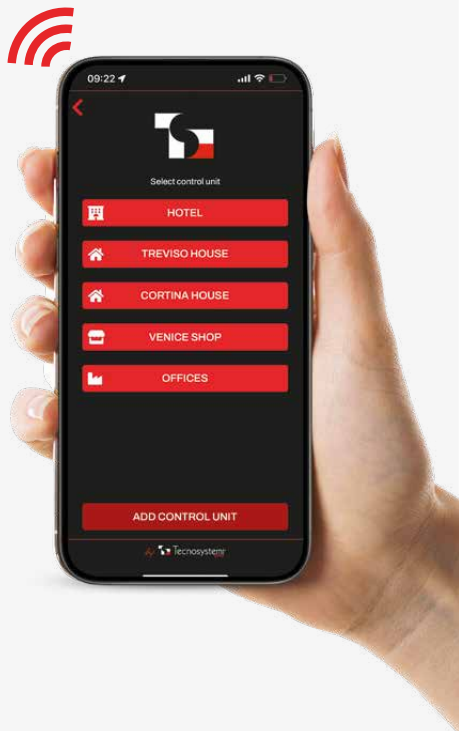

Free app available on:



Tecnosystemi



ELEGANT DESIGN AND INTUITIVE DISPLAY

SUITABLE FOR ANY KIND OF FURNITURE

The range of battery-powered and wired programmable thermostats is characterised by a **quick installation**, making it very easy to use thanks to touch buttons and the **central 4.5" or 2.4" backlit display**.



ON / OFF

Directly from the programmable thermostat or from the App



TIME PROGRAMMING

Programme the time slots and the temperature



PERCENTAGE OF HUMIDITY

Present in the environment
Humidity control with radiant system



ZONE VALVE

For radiators, radiant systems and fan coils



ENERGY SAVING

Comfort function and window contact for zone shutdown



DAMPER MOVEMENTS

Sets the opening position of the motorised damper or grille



RADIOFREQUENCY SIGNAL

Signal reception indication



SUMMER / WINTER

Set the system in cooling or heating

MODELS

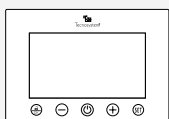

Discovery 3X

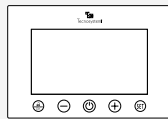

Stealth 3X



Mini Led Astra

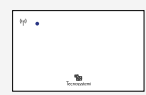

Sonda LEM



WALL-MOUNTED, BACKLIT PROGRAMMABLE THERMOSTAT TOUCH, BATTERY-RUN, RADIO FREQUENCY

TECHNICAL SPECIFICATIONS

- Power supply battery 4 x 1.5 V type AAA (LR03) supplied
- Battery life 18/24 months (normal use)
- 868 Mhz RF data transmission
- RF signal range 50 m maximum in open field between chronothermostat and "Polaris" control unit
- 4.5" backlit LCD display
- Touch keypad
- Timed or manual features
- Automatic or manual adjustment of damper and grille
- Key lock / Button lock
- Temperature scale °C / °F
- Humidity % indication
- AT and Set Point value
- Clock (AM-PM / 24h)
- Weekly and monthly programming
- Mounting: wall installation using template, screws, and plugs provided
- Compatible with POLARIS 5X controller

CHRONOTHERMOSTAT MURAL RÉTROÉCLAIRÉ AVEC BATTERIES À FRÉQUENCE RADIO TACTILE

CARACTÉRISTIQUES TECHNIQUES

- Alimentation par batterie 4 x 1,5 V type AAA (LR03) fournies
- Autonomie de la batterie 18/24 mois (compte tenu de l'utilisation normale)
- Transmission de données RF 868 Mhz
- Portée du signal RF 50 m max en champ libre entre chronothermostat et unité de contrôle « Polaris »
- Écran LCD rétroéclairé de 4,5 po
- Clavier tactile
- Fonctions chronologiques ou manuelles
- Réglage automatique ou manuel du registre et de la buse
- Verrouillage des touches
- Échelle de température °C / °F
- Indication du % d'humidité
- Valeur de TA et point de consigne
- Horloge (AM-PM / 24h)
- Programmation quotidienne et hebdomadaire
- Fixation : au mur à l'aide du gabarit, vis et chevilles fournies
- Compatible avec l'unité de commande POLARIS 5X

WANDMONTIERTES HINTERGRUNDBELEUCHTETES CHRONO-THERMOSTAT MIT BATTERIE, RADIOFREQUENZ, TOUCHDISPLAY

TECHNISCHE EIGENSCHAFTEN

- Versorgung mit Batterie 4 x 1,5 V Typ AAA (LR03) im Lieferumfang enthalten
- Batterielaufzeit 18/24 Monate (unter Berücksichtigung eines normalen Gebrauchs)
- HF-Datenübertragung mit 868 MHz
- RF-Signalreichweite max. 50 m im freien Feld zwischen Chronothermostat und "Polaris"-Steuerung
- 4,5-Zoll-LCD-Display hinterleuchtet
- Touch-Tastatur
- Chronologische oder manuelle Funktionen
- Automatische oder manuelle Verstellung von Klappe und Luftgitter
- Tastensperre
- Temperaturskala °C / °F
- Anzeige der Luftfeuchtigkeit (%)
- TA- und Sollwert
- Uhr (AM-PM / 24h)
- Tägliche und wöchentliche Programmierung
- Befestigung: Wandmontage mit Schablone, Schrauben und Dübeln im Lieferumfang
- Kompatibel mit Steuereinheit POLARIS 5X

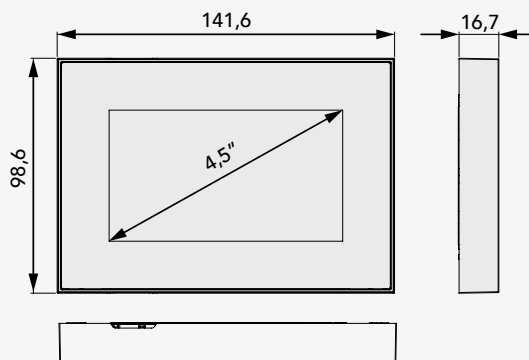

Backlit display

Thermostat Master



CODE	DESCRIPTION	U.M.	Pieces per box
GAD100005	LUMIX WHITE, WALL-MOUNTED, RADIO FREQUENCY PROGRAMMABLE THERMOSTAT - BACKLIT, DISCOVERY 3X	PCS	1



BACK-LIT TOUCH RADIO-FREQUENCY THERMOSTAT, BATTERY-POWERED FOR WALL INSTALLATION FOR PROAIR SYSTEM

TECHNICAL SPECIFICATIONS

- Power supply battery 2 x 1.5 V type AAA (LR03) supplied
- Battery life 18 months (normal use)
- 868 MHz RF radio frequency data transmission
- RF signal capacity 50 m max in open field between the chronothermostat and the "Polaris 5X" controller
- Touch display with white background
- Backlight 5 sec.
- Functions: Chrono or manual
- Timed or manual features
- Automatic or manual adjustment of damper and grille
- Timed thermostat lock
- Temperature scale °C/°F

THERMOSTAT TACTILE RÉTRO-ÉCLAIRÉ À RADIOFRÉQUENCE INSTALLATION MURALE AVEC ALIMENTATION PAR PILES POUR LE SYSTÈME PROAIR

CARACTÉRISTIQUES TECHNIQUES

- Alimentation par batterie 2 x 1,5 V type AAA (LR03) fournies
- Autonomie de la batterie 18 mois (compte tenu de l'utilisation normale)
- Transmission de données radiofréquence RF à 868 MHz
- Portée du signal RF 50 m maxi. en champ ouvert entre le chronothermostat et l'unité de commande « Polaris 5X »
- Afficheur tactile à fond blanc
- Rétroéclairage 5 sec.
- Fonctions chronologiques ou manuelles
- Réglage automatique ou manuel du registre et de la buse
- Bloc chronothermostat
- Temperature scale °C/°F

HOCHFREQUENZ-TOUCH-THERMOSTAT MIT HINTERGRUNDBELEUCHTUNG, FÜR WANDMONTAGE, BATTERIEGESPEIST, FÜR PROAIR-SYSTEME

TECHNISCHE EIGENSCHAFTEN

- Versorgung mit Batterie 2 x 1,5 V Typ AAA (LR03) im Lieferumfang enthalten
- Batterielaufzeit 18 Monate (unter Berücksichtigung des normalen Gebrauchs)
- Hochfrequenz-Datenübertragung mit 868 MHz
- Reichweite des Signals RF max. 50 m auf freiem Feld zwischen Chronothermostat und Steuereinheit „Polaris 5X“
- Touch-Screen-Display mit weißem Hintergrund
- Hintergrundbeleuchtung 5 Sek.
- Chronologische oder manuelle Funktionen
- Automatische oder manuelle Verstellung von Klappe und Luftgitter
- Sperre des Chrono-Thermostats
- Temperature scale °C/°F

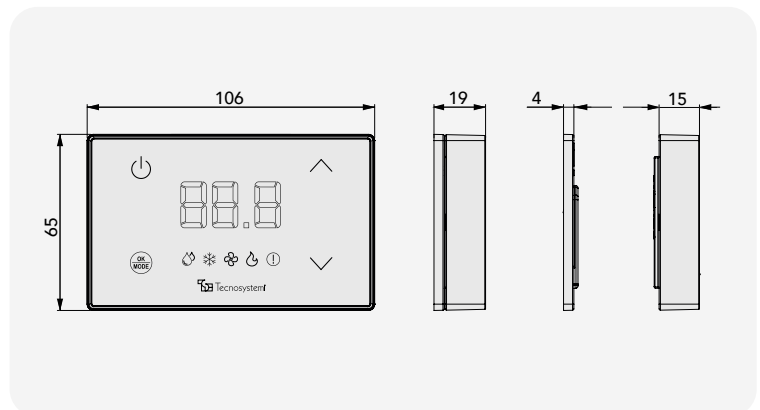

Master / Slave Function

CODE	DESCRIPTION	U.M.	Pieces per box
GAD100016	"MINI-LED ASTRA" THERMOSTAT , TOUCH, IN RADIO FREQUENCY, BATTERY OPERATING, WALL INSTALLATION	PCS	1





WALL-MOUNTED ROOM PROBE WITH RADIO FREQUENCY BATTERIES

TECHNICAL SPECIFICATIONS

- Power supply battery 2 x 1.5 V type AAA (LR03) supplied
- Battery life 18 months
- 868 MHz RF radio frequency data transmission
- RF signal capacity 25 m max in open field between the chronothermostat and the Polaris 5X" controller
- Temperature sensor
- Moisture sensor
- Wall fastening using template, screws and fixing plugs supplied
- Indicator LED
- Wall fastening using template, screws and fixing plugs supplied

SONDE MURALE EN RADIOFRÉQUENCE AVEC BATTERIES

CARACTÉRISTIQUES TECHNIQUES

- Alimentation par batterie 2 x 1,5 V type AAA (LR03) fournies
- Autonomie de la batterie 18 mois
- Transmission de données radiofréquence RF à 868 MHz
- Portée du signal RF 25 m maxi. en champ ouvert entre le chronothermostat et l'unité de commande « Polaris 5X »
- Capteur de température
- Capteur d'humidité
- Montage mural à l'aide du gabarit, des vis et des chevilles fournis
- LED indicateur
- Montage mural à l'aide du gabarit, des vis et des chevilles fournis

WANDMONTIERTE RAUMSONDE HOCHFREQUENZBATTERIEN

TECHNISCHE EIGENSCHAFTEN

- Versorgung mit Batterie 2 x 1,5 V Typ AAA (LR03) im Lieferumfang enthalten
- Batterielaufzeit 18 Monate
- Hochfrequenz-Datenübertragung mit 868 MHz
- Reichweite des Signals RF max. 25 m auf freiem Feld zwischen Chronothermostat und Steuereinheit „Polaris 5X“
- Temperatursensor
- Feuchtigkeitssensor
- Wandmontage mit mitgelieferter Lehre, Schrauben und Dübeln
- Anzeigelampe (LED)
- Wandmontage mit mitgelieferter Lehre, Schrauben und Dübeln

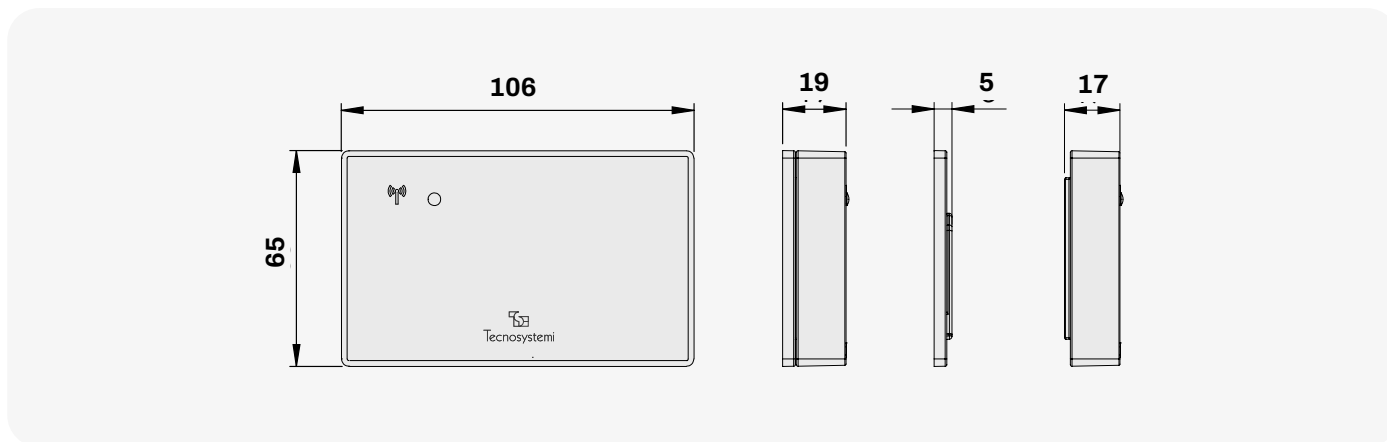
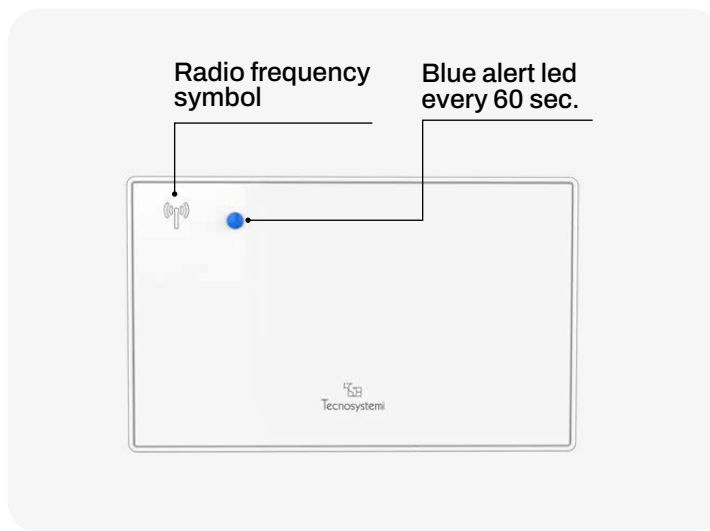

Power supply battery and radio frequency data transmission.

LEM probes must always be combined with a Discovery 3X or Stealth 3X thermostat carrying out the master function.

Slave Function

CODE	DESCRIPTION	U.M.	Pieces per box
GAD100011	"LEM 3X" WALL-FITTED ROOM PROBE WITH BATTERIES ON RADIO FREQUENCY- LUMIX WHITE	PCS	1





BUILT-IN WIRED BACKLIT PROGRAMMABLE THERMOSTAT WITH TOUCH

TECHNICAL SPECIFICATIONS

- Power supply and data transmission: 4-pin cable
- 4.5" LCD display with white backlit background
- Touch keypad
- Timed or manual features
- Automatic or manual adjustment of damper and grille
- Timed thermostat lock
- Temperature scale °C / °F
- Humidity % indication
- AT and set point value
- Clock (AM - PM / 24h)
- Weekly and monthly programming
- Signal range 100 m max between programmable thermostat and POLARIS
- Protrusion from flush wall 14 mm
- Mounting: flush-mounted on E503-type boxes using adapter, screws, and plugs provided
- Compatible with POLARIS 5X controller

CHRONOTHERMOSTAT ENCASTRÉ ET RÉTROÉCLAIRÉ FILAIRE

CARACTÉRISTIQUES TECHNIQUES

- Alimentation et transmission de données : câble à 4 pôles
- Écran LCD 4,5" avec fond blanc rétroéclairé
- Clavier tactile
- Fonctions chronologiques ou manuelles
- Réglage automatique ou manuel du registre et de la buse
- Bloc chronothermostat
- Échelle de température °C / °F
- Indication du % d'humidité
- Valeur de TA et point de consigne
- Horloge (AM - PM / 24h)
- Programmation quotidienne et hebdomadaire
- Plage de signal de 100 m maxi entre le thermostat programmable et l'unité de commande POLARIS
- Protubérance à partir du bord du mur 14 mm
- Fixation : encastrée sur boîtiers type E503 à l'aide d'un adaptateur, vis et chevilles fournies
- Compatible avec l'unité de commande POLARIS 5X

HINTERGRUNDBELEUCHTES EINBAU-CHRONO-THERMOSTAT VERKABELT MIT TOUCHDISPLAY

TECHNISCHE EIGENSCHAFTEN

- Versorgung und Datenübertragung: 4-poliges Kabel
- 4,5-Zoll-LCD-Display weiß hinterleuchtet
- Touch-Tastatur
- Chronologische oder manuelle Funktionen
- Automatische oder manuelle Verstellung von Klappe und Luftgitter
- Sperre des Chrono-Thermostats
- Temperaturskala °C / °F
- Anzeige der Luftfeuchtigkeit (%)
- TA- und Sollwert
- Uhr (AM - PM / 24h)
- Tägliche und wöchentliche Programmierung
- Reichweite des Signals max. 100 m zwischen Chrono-Thermostat und POLARIS
- Überstand von der Wandkante 14 mm
- Befestigung: Einbau in E503-Standarddosen mit Adapter, Schrauben und Dübeln im Lieferumfang enthalten
- Kompatibel mit Steuereinheit POLARIS 5X

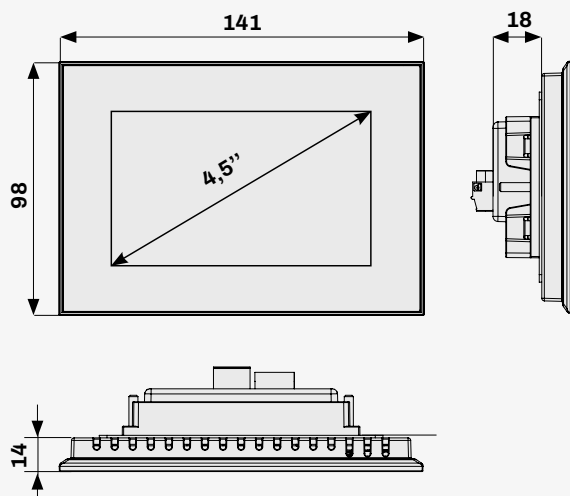

4.5" Backlit LCD display

Power supply and data transmission by wiring.

CODE	DESCRIPTION	U.M.	 Pieces per box
GAD100015	LUMIX WHITE, BUILT-IN, CABLE PROGRAMMABLE THERMOSTAT - BACKLIT, STEALTH 3X	PCS	1



MOTORISED CIRCULAR DAMPER / MOTORISED CIRCULAR BY-PASS FOR SYSTEM

TECHNICAL SPECIFICATIONS

- Electronic actuator with position indicator: 0° - 33° - 66° - 100°
- Made of plastic
- Ensures thermal insulation between the inner and outer surfaces

MADE OF ANTI-CONDENSATION ABS PLASTIC

FERMETURE CIRCULAIRE MOTORISÉE/PASSE CIRCULAIRE MOTORISÉ POUR SYSTÈME

CARACTÉRISTIQUES TECHNIQUES

- Actionneur électronique avec indicateur de position : 0° - 33° - 66° - 100°
- Fabriqué en matière plastique
- Assure l'isolation thermique entre la surface intérieure et la surface extérieure

FABRIQUÉ EN MATIÈRE PLASTIQUE WANTI-CONDENSATION

MOTORISIERTE KREISKLAPPE / MOTORISIERTER KREISBYPASS FÜR SYSTEM

TECHNISCHE EIGENSCHAFTEN

- Elektronischer Stellaktor mit Positionsanzeige: 0° - 33° - 66° - 100°
- Aus Kunststoff
- Gewährleistet die thermische Isolierung zwischen Innen- und Außenfläche

HERGESTELLT AUS ANTIKONDENSATIONS-KUNSTSTOFF

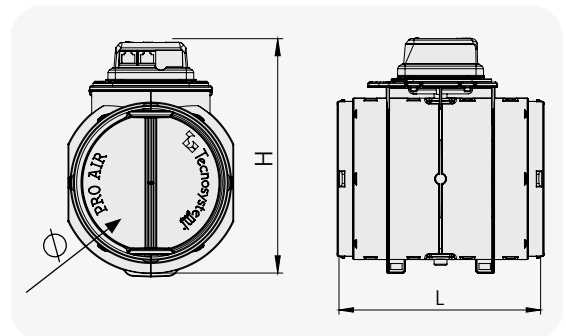

ATTENTION! Use only Tecnosystemi cables - do not use cables other than those indicated in order not to compromise the correct functioning of the system. Always provide an inspection hatch for access to the control unit and dampers. Always install the dampers with the motor facing downwards.



For the airflow and pressure loss curves at the three calibration settings, please refer to the technical data sheet.

CODE	DIMENSIONS [mm]			MAX AIR FLOW RATE m³/h	U.M.	Pieces per box
	Ø COUPLER	H	L			
GAD300019	150	218	190	388	PCS	1
GAD300020	200	268	190	678	PCS	1

FIXING COLLAR ON PLENUM FOR MOTORISED DAMPER Ø 150 - 200

COLLIER DE FIXATION SUR PLÉNUM POUR REGISTRE MOTORISÉ Ø 150 - 200

BEFESTIGUNGSSCHELLE AM PLENUM FÜR MOTORISIERTE Klappe Ø 150 - 200



CODE	Ø [mm]	U.M.	Pieces per box
GAD300021	150	PCS	1
GAD300022	200	PCS	1



UK MOTORISED CIRCULAR DAMPER / MOTORISED CIRCULAR BY-PASS FOR SYSTEM

TECHNICAL SPECIFICATIONS

- Electronic actuator
- Made of plastic
- Ensures thermal insulation between the inner and outer surfaces

MADE OF ANTI-CONDENSATION ABS PLASTIC

FR FERMETURE CIRCULAIRE MOTORISÉE/PASSE CIRCULAIRE MOTORISÉ POUR SYSTÈME

CARACTÉRISTIQUES TECHNIQUES

- Actionneur électronique
- Fabriqué en matière plastique
- Assure l'isolation thermique entre la surface intérieure et la surface extérieure

FABRIQUÉ EN MATIÈRE PLASTIQUE ANTI-CONDENSATION

DE MOTORISIERTE KREISKLAPPE / MOTORISIERTER KREISBYPASS FÜR SYSTEM

TECHNISCHE EIGENSCHAFTEN

- Elektronischer Stellaktor
- Aus Kunststoff
- Gewährleistet die thermische Isolierung zwischen Innen- und Außenfläche

HERGESTELLT AUS ANTIKONDENSATIONS-KUNSTSTOFF

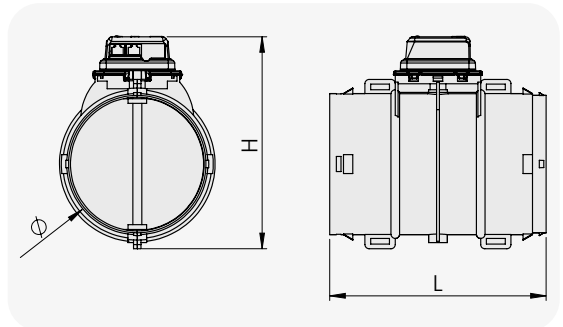

ATTENTION! Use only Tecnosystemi cables - do not use cables other than those indicated in order not to compromise the correct functioning of the system. **Always provide an inspection hatch for access to the control unit and dampers.** Always install the dampers with the motor facing downwards.

CODE	DIMENSIONS			MAX AIR FLOW RATE	U.M.	Pieces per box
	Ø COUPLER [mm]	H [mm]	L [mm]			
11181530	250	330	280	m ³ /h	PCS	1
11181540	300	380	350	m ³ /h	PCS	1



UK FIXING COLLAR ON PLENUM FOR MOTORISED CIRCULAR DAMPER Ø 150 - 200 - 250 - 300

FR COLLIER DE FIXATION SUR PLÉNUM POUR VANNE CIRCULAIRE MOTORISÉE Ø 150 - 200 - 250 - 300

DE BEFESTIGUNGSSCHELLE AM PLENUM FÜR MOTORISIERTEN RUNDKLAPPEN Ø 150 - 200 - 250 - 300



CODE	Ø [mm]	U.M.	Pieces per box
C20000808	250	PCS	1
C20000809	300	PCS	1



 **WHITE MOTORISED DELIVERY GRILLE COMPLETE WITH GASKET FOR THE SYSTEM**

TECHNICAL SPECIFICATIONS

- Electronic actuator
- Mounted using steel clips
- Flaps with rubber gasket for a complete seal

MADE OF WHITE PAINTED ALUMINIUM

 **GRILLE DE REFOULEMENT MOTORISÉE BLANCHE AVEC JOINT POUR SYSTÈME**

CARACTÉRISTIQUES TECHNIQUES

- Actionneur électronique
- Montage à l'aide de clips en acier
- Ailettes avec joint en caoutchouc pour une étanchéité totale

FABRIQUÉS EN ALUMINIUM PEINT EN BLANC

 **WEISSE MOTORISIERTE ZULUFTGITTER EINSCHLIESSLICH DICHTUNG FÜR DAS SYSTEM**

TECHNISCHE EIGENSCHAFTEN

- Elektronischer Stellaktor
- Montage mit Stahlclips
- Klappen mit Gummidichtung für eine vollständige Abdichtung

AUS WEISS LACKIERTEM ALUMINIUM

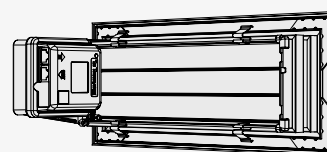

Closed flaps detail

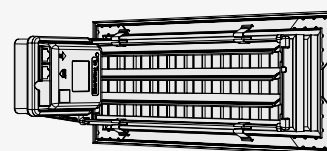

Opened flaps detail

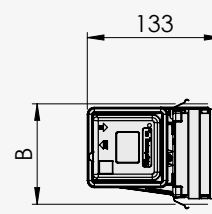
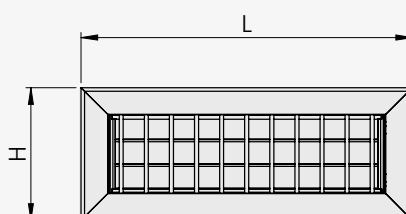
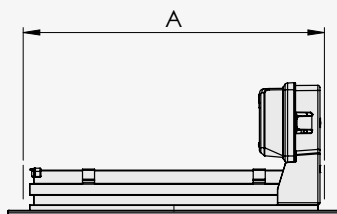

For plenums see page 14 of the PROJECT WIND catalog

ATTENTION! Use only Tecnosystemi cables - do not use cables other than those indicated in order not to compromise the correct functioning of the system.

CODE	DIMENSIONS [mm]				MAX AIR FLOW [m³/h]	MAX SPEED [m/s]	U.M.	 Pieces per box
	A	B	L	H				
11181610	300	100	332	132	350	6.8	PCS	1
11181620	300	150	332	182	550	6.7	PCS	1
11181630	300	200	332	232	760	6.8	PCS	1
11181640	400	100	432	132	490	6.8	PCS	1
11181650	400	150	432	182	760	6.8	PCS	1
11181660	400	200	432	232	1030	6.8	PCS	1
11181670	500	100	532	132	620	6.7	PCS	1
11181680	500	150	532	182	960	6.8	PCS	1



VIDEO



DATASHEET

RELAY MODULE FOR RADIANT SYSTEMS AND FAN COILS

TECHNICAL SPECIFICATIONS

- Connection to system with RJ45 plug connectors for 8-wire cables
- Fastening on DIN rail
- Dimensions 4 modules L 70 x H 90 x D 62
- Powered via data bus through Polaris control unit
- 4 Output relays
- 4 LEDs to indicate the status of the relay
- LEDs for signalling and diagnostics
- Input for external temperature sensor (type ntc 10kΩ at 25°C, not supplied)
- Contact rating:
 - maximum resistive load 8A at 230 VAC

MODULE RELAIS POUR SYSTÈMES RADIANTS ET VENTILATEURS

CARACTÉRISTIQUES TECHNIQUES

- Raccordement au système avec connecteurs RJ45 pour câbles à 8 pôles
- Fixation sur rail DIN
- Dimensions 4 modules L 70 x H 90 x P 62
- Alimentation via bus de données par l'unité de contrôle Polaris
- 4 relais de sortie
- 4 LED pour l'indication de l'état du relais
- LED pour la signalisation et le diagnostic
- Entrée pour capteur de température externe (type ntc 10kΩ à 25°C, non fourni)
- Capacité de contact :
 - 8A à 230 Vac charge résistive maximale

RELAISMODUL FÜR STRAHLUNGSSYSTEME UND LÜFTERSPULEN

TECHNISCHE EIGENSCHAFTEN

- Anschluss an das System mit RJ45-Steckverbindern für 8-polige Kabel
- Befestigung an DIN Führung
- Abmessungen 4 Module B 70 x H 90 x T 62
- Versorgung über Datenbus durch die Polaris-Steuereinheit
- 4 Ausgangsrelais
- 4 LED für Statusanzeige des Relais
- LED für Signalisierung und Diagnose
- Eingang für externen Temperatursensor (Typ ntc 10kΩ bei 25°C, nicht mitgeliefert)
- Kontaktkapazität:
 - 8 A bei 230 Vac maximale ohmsche Last



WIRED CONNECTION EXAMPLES

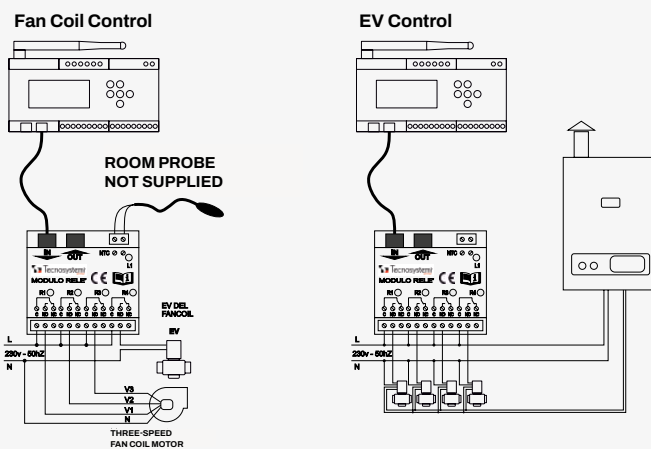

CODE	DESCRIPTION	U.M.	Pieces per box
11181407	RELAY MODULE FOR FAN COIL OR ZONE VALVES	PCS	1



CONSUMPTION METER FOR PROAIR SYSTEM

TECHNICAL SPECIFICATIONS

- 2 modules dimensions W 35 x H 90 x D 62
- Fastening on DIN rail
- Radio frequency transmission only with the "Polaris 5X" controller
- Current sensor supplied
- LEDs for signalling and diagnostics
- Can only be combined with "Polaris 5X" control unit

COMPTEUR DE CONSOMMATION POUR LE SYSTÈME PROAIR

CARACTÉRISTIQUES TECHNIQUES

- 2 modules dimensions L 35 x H 90 x P 62
- Fixation sur rail DIN
- Transmission par radiofréquence uniquement avec la centrale "Polaris 5X"
- Capteur de courant fourni
- LED pour la signalisation et le diagnostic
- Peut être couplé uniquement à l'unité de contrôle « Polaris 5X »

VERBRAUCHSZÄHLER FÜR PROAIR-SYSTEM

TECHNISCHE EIGENSCHAFTEN

- 2 Abmessungen moduls L 35 x H 90 x T 62
- Befestigung an DIN Führung
- Funkübertragung nur mit der Steuereinheit „Polaris 5X“
- Stromsensor im Lieferumfang enthalten
- LED für Signalisierung und Diagnose
- Kann nur mit dem Steuergerät „Polaris 5X“ kombiniert werden



MADE IN ITALY

Only for Polaris 5X control unit

CODE	DESCRIPTION	U.M.	Pieces per box
GAD100014	CONSUMPTION METER FOR PROAIR SYSTEM	PCS	1



WINDOW CONTACT IN RADIO FREQUENCY FOR PROAIR SYSTEM (ALSO PREPARED FOR WIRING)

TECHNICAL SPECIFICATIONS

- Power supply CR2032 battery (supplied as standard)
- RF transmission with "Polaris" control unit
- RF module and magnet
- RF module provided with terminal for management of a wired window contact
- Red window open LED
- Can be configured by the "Polaris" control units for Badge Management
- RF transmitter module dimensions 95 x 29 x 20 mm
- Dimensions of magnet 38 x 19 x 13 mm

CONTACT DE FENÊTRE EN RADIO POUR SYSTÈME PROAIR FRÉQUENCE (ÉGALEMENT PRÉDISPOSÉ POUR LE CÂBLAGE)

CARACTÉRISTIQUES TECHNIQUES

- Alimentation par batterie CR2032 (fournie de série)
- Transmission RF avec l'unité de contrôle « Polaris »
- Composée d'un module RF et d'un aimant
- Module RF muni d'une borne pour la gestion d'un contact de fenêtre câblé
- LED de signalisation rouge à fenêtre ouverte
- Peut être configuré par les unités de contrôle « Polaris » pour la gestion des Badges
- Dimensions du module émetteur RF 95 x 29 x 20 mm
- Taille de l'aimant 38 x 19 x 13 mm

HOCHFREQUENZ-FENSTERKONTAKT FÜR PROAIR-SYSTEM (AUCH FÜR VERDRÄHTUNG AUSGELEGT)

TECHNISCHE EIGENSCHAFTEN

- CR2032 Batterieversorgung (serienmäßig im Lieferumfang enthalten)
- RF-Übertragung mit Steuergerät „Polaris“
- Bestehend aus RF-Modul und Magnet
- RF-Modul mit einem Terminal zur Verwaltung eines verdrahteten Fensterkontakts
- Rote LED Signalisierung offenes Fenster
- Konfigurierbar durch "Polaris" Ausweisverwaltungseinheiten
- Sendermodulmasse RF 95 x 29 x 20 mm
- Masse Magnet 38 x 19 x 13 mm

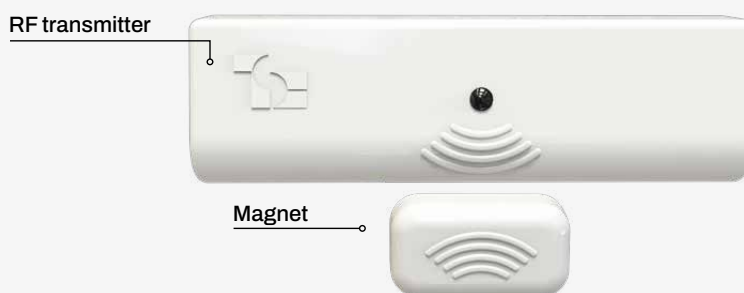

EXAMPLE WITH RF TRANSMITTER MODULE



EXAMPLE WITH RF TRANSMITTER MODULE WITH WIRING



INSTALLATION WITH RF TRANSMITTER

Application recommended for wireless installation. In this mode, the RF transmitter or multiple RF transmitters associated with a zone, transmit directly to the control unit.

WIRED INSTALLATION WITH RF TRANSMITTER

Recommended application when the RF transmitter and the Polaris control unit are out of RF range. A **wired window contact (not supplied by Tecnosystemi)**, will be connected to the terminal board available in the radio module of the RF transmitter which will send the signal for opening or closing of the window via RF to the control unit.

CODE	DESCRIPTION	U.M.	Pieces per box
GAD400254	WINDOW CONTACT FOR PROAIR SYSTEM	PCS	1





LABELLED CONNECTION CABLE FOR PROAIR MULTI-ZONE SYSTEM - 8 POLES

TECHNICAL SPECIFICATIONS

- RJ45 plug connectors
- Lengths from 0.5 - 1 - 3 - 6 - 10 m
- 8-pin flat cable



CÂBLE DE CONNEXION EN TÊTE POUR SYSTÈME PROAIR MULTI-ZONE - 8 PÔLES

CARACTÉRISTIQUES TECHNIQUES

- Connecteurs enfichables RJ45
- Longueurs de 0,5 - 1 - 3 - 6 - 10 m
- Câble plat 8 broches



TERMINIERTES ANSCHLUSSKABEL FÜR PROAIR MULTI-ZONE SYSTEM - 8-POLIG

TECHNISCHE EIGENSCHAFTEN

- RJ45-Steckverbinder
- Längen von 0,5 - 1 - 3 - 6 - 10 m
- 8-poliges Flachkabel



For wiring dampers, motorized grille and relay modules.

ATTENTION! Use only Tecnosystemi cables - do not use cables other than those indicated in order not to compromise the correct functioning of the system.

CODE	DESCRIPTION	U.M.	 Pieces per box
11181710	CONNECTION CABLE WITH CONNECTOR FOR PRO AIR MULTI-ZONE SYSTEMS 0,5m	PCS	1
11181720	CONNECTION CABLE WITH CONNECTOR FOR PRO AIR MULTI-ZONE SYSTEMS 1m	PCS	1
11181730	CONNECTION CABLE WITH CONNECTOR FOR PRO AIR MULTI-ZONE SYSTEMS 3m	PCS	1
11181740	CONNECTION CABLE WITH CONNECTOR FOR PRO AIR MULTI-ZONE SYSTEMS 6m	PCS	1
11181750	CONNECTION CABLE WITH CONNECTOR FOR PRO AIR MULTI-ZONE SYSTEMS 10m	PCS	1



SKEIN CONNECTION CABLE FOR PROAIR MULTI-ZONE SYSTEM - 8 POLES

TECHNICAL SPECIFICATIONS

- 100 m reel
- 8-pin flat cable
- For wiring dampers, motorized outlets, and relay modules



CÂBLE DE CONNEXION À BROCHE POUR SYSTÈME MULTI-ZONE PROAIR - 8 PÔLES

CARACTÉRISTIQUES TECHNIQUES

- Bobine de 100 m
- Câble plat 8 broches
- Pour le câblage des volets, des bouches motorisées et des modules relais



ANSCHLUSSKABEL AUF SPULE FÜR DIE SYSTEME PROAIR MULTI-ZONE - 8-POLIG

TECHNISCHE EIGENSCHAFTEN

- 100 m Strang
- 8-poliges Flachkabel
- Für die Verkabelung von Klappen, motorisierten Auslässen und Relaismodulen



ATTENTION! Use only Tecnosystemi cables - do not use cables other than those indicated in order not to compromise the correct functioning of the system.

CODE	DESCRIPTION	U.M.	 Pieces per box
11181760	CONNECTION CABLE HANK PRO AIR MULTI-ZONE SYSTEM 100m	PCS	1



100 M SKEIN CONNECTION CABLE FOR STEALTH 3X 4-POLE WIRED BUILT-IN PROGRAMMABLE THERMOSTAT

TECHNICAL SPECIFICATIONS

- 4 x 0.22 shielded cable
- 100 m reel
- 4-pole cable

CÂBLE DE CONNEXION EN ÉCHEVEAU 100 M POUR THERMOSTAT PROGRAMMABLE ENCASTRÉ CÂBLE STEALTH 3X - 4 PÔLES

CARACTÉRISTIQUES TECHNIQUES

- Câble 4 x 0,22 blindé
- Bobine de 100 m
- Câble à 4 pôles

ANSCHLUSSKABEL AUF 100-M-SPULE FÜR VERKABELTES EINBAU-CHRONO-THERMOSTAT STEALTH 3X - 4-POLIG

TECHNISCHE EIGENSCHAFTEN

- 4 x 0,22 abgeschirmtes Kabel
- 100 m Strang
- 4-poliges Kabel



For built-in wired backlit Stealth 3X thermostat



CODE	DESCRIPTION	U.M.	Pieces per box
11181764	100m CONNECTION CABLE HANK FOR "STEALTH 2X2 BUILT-IN, CABLED CHRONO-THERMOSTAT	PCS	1



TSTC1

NETWORK CABLE TESTER

TECHNICAL SPECIFICATIONS

- Suitable for testing on RJ45 type cables
- Suitable for coaxial cable testing

TESTEUR DE CÂBLE RÉSEAU TSTC1

CARACTÉRISTIQUES TECHNIQUES

- Convient pour les essais sur les câbles de type RJ45
- Convient pour les essais sur les câbles coaxiaux

TSTC1-NETZWERKKABELTESTER

TECHNISCHE EIGENSCHAFTEN

- Geeignet zum Testen von Kabeln des Typs RJ45
- Geeignet für die Prüfung von Koaxialkabeln



CODE	DESCRIPTION	U.M.	Pieces per box
11132600	TESTER FOR NETWORK CABLES TSTC1	PCS	1



RJ45 CONNECTOR FOR 8-PIN CONNECTION CABLES FOR PROAIR MULTI-ZONE SYSTEM

TECHNICAL SPECIFICATIONS

- 100 Pieces pack
- RJ45 Connector for 8-pin cables for Proair Multi-Zone System

CONNECTEUR RJ45 POUR CÂBLES 8 PÔLES DE RACCORDEMENT POUR SYSTÈME PROAIR MULTI-ZONE

CARACTÉRISTIQUES TECHNIQUES

- Pack de 100 pièces
- Connecteur RJ45 pour câbles à 8 broches pour le système Proair Multi-Zone

RJ45-STECKVERBINDER FÜR 8-POLIGE VERBINDUNGSKABEL FÜR DAS SYSTEM PROAIR MULTI-ZONE

TECHNISCHE EIGENSCHAFTEN

- 100-teiliges Set
- RJ45-Steckverbinder für 8-polige Kabel für das Proair Multi-Zonen-System



CODE	DESCRIPTION	U.M.	Pieces per box
11181770	RJ45 CONNECTOR FOR 8-WIRE CONNECTION CABLES FOR PRO AIR MULTI-ZONE SYSTEM	PCS	1



 **MECHANICAL CIRCULAR BYPASS Ø 200 FOR PLENUM EOLO - EOLO MINI**

 **DÉRIVATION CIRCULAIRE MÉCANIQUE Ø 200 POUR PLÉNUM EOLO- EOLO MINI**

 **MECHANISCHER KREISFÖRMIGER BYPASS Ø 200 FÜR PLENUM EOLO - EOLO MINI**



Suitable for Plenum Eolo - Eolo Mini

CODE	DESCRIPTION	U.M.	 Pieces per box
GAD300006	MECHANICAL ROUND BY-PASS FOR PLENUM "EOLO" - "EOLO MINI" Ø 200	PCS	1



 **MECHANICAL DOOR BYPASS FOR METAL AND POLYURETHANE FOAM (PAL) PLENUMS**

 **DÉRIVATION MÉCANIQUE À PORTE POUR PLÉNUM EN MÉTAL ET EN POLYURÉTHANE EXPANSÉ (PAL)**

 **MECHANISCHER BYPASS MIT Klappe FÜR PLENUM AUS METALL UND POLYURETHANSCHAUM (PAL)**



Or metal and polyurethane foam (PAL) plenums

CODE	DESCRIPTION	U.M.	 Pieces per box
GAD400201	MECHANICAL BY PASS WITH FLAP (KIT FOR INSTALLATION)	PCS	1



 **MECHANICAL BYPASS**

 **DÉRIVATION MÉCANIQUE**

 **MECHANISCHER BYPASS**



RECTANGULAR BYPASS

CODE	LENGTH	HEIGHT	MAX AIR FLOW RATE	U.M.	 Pieces per box
	[mm]	[mm]	[m³/h]		
11161295	400	150	860	PCS	1
11161296	400	200	1150	PCS	1



CIRCULAR BYPASS

CODE	LENGTH	HEIGHT	MAX AIR FLOW RATE	U.M.	 Pieces per box
	[mm]	[mm]	[m³/h]		
11161297	150	250	388	PCS	1
11161298	200	300	670	PCS	1



CONFIGURE YOUR PROAIR PACK



 On the website tecnosystemi.com

Automatically generates **quotations** and **datasheets** for the chosen products



Caution: the configurator includes only ProAir Pack products

CONFIGURE YOUR PROAIR PACK HYDRONIC



 On the website tecnosystemi.com

Automatically generates **quotations** and **datasheets** for the chosen products



CONFIGURE YOUR SYSTEM WITH ALL THE PROAIR SYSTEM LOOSE ELEMENTS

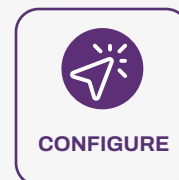

 On the website tecnosystemi.com

Automatically generates **quotations** and **datasheets** for the chosen products



HOW TO CHOOSE YOUR PROAIR PACK

Polaris 5X with colour display, wi-fi communication protocols and Alexa app - Google Home



CHRONO-THERMOSTATS WITH RADIO FREQUENCY

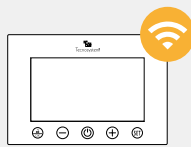

WIRED CHRONO-THERMOSTATS

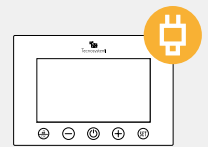

PLENUM EOLO MINI

N° ZONES	Ø COLLAR	PAGE
3	from Ø 125 / 150	33
4	from Ø 125 / 150	35

PLENUM EOLO MINI

N° ZONES	Ø COLLAR	PAGE
3	from Ø 125 / 150	43
4	from Ø 125 / 150	45

PLENUM EOLO

N° ZONES	Ø COLLAR	PAGE
2	from Ø 150 / 200	31
3	from Ø 150 / 200	33
4	from Ø 150 / 200	35
5	from Ø 150 / 200	37
6	from Ø 150 / 200	39

PLENUM EOLO

N° ZONES	Ø COLLAR	PAGE
2	from Ø 150 / 200	43
3	from Ø 150 / 200	44
4	from Ø 150 / 200	45
5	from Ø 150 / 200	46
6	from Ø 150 / 200	on request

METAL SHEET PLENUM / PAL*

N° ZONES	Ø COLLAR	PAGE
2	from Ø 150 / 200	32
3	from Ø 150 / 200	34
4	from Ø 150 / 200	36
5	from Ø 150 / 200	38
6	from Ø 150 / 200	40

METAL SHEET PLENUM / PAL*

N° ZONES	Ø COLLAR	PAGE
2	from Ø 150 / 200	43
3	from Ø 150 / 200	44
4	from Ø 150 / 200	45
5	from Ø 150 / 200	46
6	from Ø 150 / 200	47

* Polyurethane foam PAL available on request

CONTENTS OF "PROAIR-RF" PACK KITS

All ProAir packs are tested and configured, ready to be installed.
Matching between chrono-thermostats and dampers is identified by numbering.

RADIO FREQUENCY (RF) PROAIR PACK PLENUM EOLO / EOLO MINI



PAG. 48

1 PCS.

Sintered polystyrene delivery plenum for ducted units (specify the plenum code when ordering). Mechanical bypass kit to be fastened to right or left side of plenum (includes fastening ring nut and counterweight)

PROAIR PACK RF INSULATED METAL SHEET / POLYURETHANE FOAM (PAL)



PAG. 48

1 PCS.

Insulated inlet plenum for ducted units (specify the plenum code when ordering). Polyurethane foam pal available on request



PAG. 10-11

1 PCS.

Polaris 5x control unit with colour display, incorporated protocols and app, alexa e google home



PAG. 10-11

1 PCS.

Polaris 5x control unit with colour display, incorporated protocols and app, alexa e google home



PAG. 14-18

ACCORDING TO THE QUANTITY OF ZONES

Chrono-thermostats (colour: white)
choose among the proposed solution: A, B,C



PAG. 14-18

ACCORDING TO THE QUANTITY OF ZONES

Chrono-thermostats (colour: white)
choose among the proposed solution: A, B,C



ACCORDING TO THE QUANTITY OF ZONES

Motorized dampers integrated on plenum



ACCORDING TO THE QUANTITY OF ZONES

Motorized dampers integrated on plenum

The proair pack may be customized with dampers having different diameters.

ATTENTION: a clean on/of contact can be used if an infrared receiver is not available (check with the ducted manufacturer whether the machine needs a suitable interface).



2 ZONES WITH PLENUM IN POLYSTYRENE "EOLO"
Ø150/200 mm

With **POLARIS 5X WI-FI** control unit with colour display - Wi-Fi, Alexa, Google Home



NOTE: FOR KIT COMPONENTS LIST SEE PAGE 30

N. 2 DISCOVERY 3X

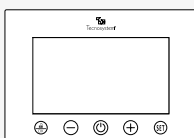

CODE	DESCRIPTION	COUPLING Ø	U.M.	Pieces per box
GAD400359	PROAIR PACK RF RED 2 - WITH PLENUM EOLO IN POLYSTYRENE WITH 2 CHRONOTERMOSTATS DISCOVERY 3X BACKLIT - WITH CONTROL UNIT POLARIS 5X - Ø150/200 mm	150/200mm	PCS	1

N. 2 MINI LED ASTRA



CODE	DESCRIPTION	COUPLING Ø	U.M.	Pieces per box
GAD400493	PROAIR PACK RF RED 2 WITH PLÉNUM IN POLYSTYRENE EOLO WITH 2 THERMOSTATS MINI LED - WITH TROL UNIT POLARIS 5X - 150/200 m	150/200mm	PCS	1

N. 1 DISCOVERY 3X N. 1 ROOM PROBE LEM 3X



CODE	DESCRIPTION	COUPLING Ø	U.M.	Pieces per box
GAD400409	PLÉNUM EOLO IN POLYSTYRENE - WITH 1 CHRONOTERMOSTAT DISCOVERY 3X BACKLIT + 1 PROBE AMBIENTE LEM 3X RF - WITH CONTROL UNIT POLARIS 5X - Ø150/200 mm	150/200mm	PCS	1

The plenum for duct units is included. (Please, in time of order specify code of plenum, see from page 48)



2 ZONES WITH INSULATED METAL SHEET PLENUM

With **POLARIS 5X WI-FI** control unit with colour display - Wi-Fi, Alexa, Google Home



NOTE: FOR KIT COMPONENTS LIST SEE PAGE 30

N. 2 DISCOVERY 3X

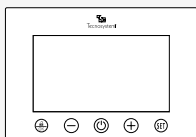

CODE	DESCRIPTION	DAMPERS Ø	U.M.	Pieces per box
GAD400379	PROAIR PACK RF RED 2 L - WITH 2 CHRONOTERMOSTATS DISCOVERY 3X BACKLIT - WITH CONTROL UNIT POLARIS 5X - Ø150 mm	150 mm	PCS	1
GAD400380	PROAIR PACK RF RED 2 L - WITH 2 CHRONOTERMOSTATS DISCOVERY 3X BACKLIT - WITH CONTROL UNIT POLARIS 5X - Ø200 mm	200 mm	PCS	1

N. 2 MINI LED ASTRA



CODE	DESCRIPTION	DAMPERS Ø	U.M.	Pieces per box
GAD400495	PROAIR PACK RF RED 2 L - 2 THERMOSTATS MINI LED - WITH TROL UNIT POLARIS 5X - 150 mm	150 mm	PCS	1
GAD400496	PROAIR PACK RF RED 2 L - 2 THERMOSTATS MINI LED - WITH TROL UNIT POLARIS 5X - 200 mm	200 mm	PCS	1

**N. 1 DISCOVERY 3X
N. 1 ROOM PROBE LEM 3X**



CODE	DESCRIPTION	DAMPERS Ø	U.M.	Pieces per box
GAD400416	PROAIR PACK RF RED 2 L - WITH 1 CHRONOTERMOSTAT DISCOVERY 3X BACKLIT + 1 PROBE AMBIENTE LEM 3X RF - WITH CONTROL UNIT POLARIS 5X - Ø150 mm	150 mm	PCS	1
GAD400417	PROAIR PACK RF RED 2 L - WITH 1 CHRONOTERMOSTAT DISCOVERY 3X BACKLIT + 1 PROBE AMBIENTE LEM 3X RF - WITH CONTROL UNIT POLARIS 5X - Ø200 mm	200 mm	PCS	1

The plenum for duct units is included. **(Please, in time of order specify code of plenum, see from page 48)**

ProAirRF

pack 3 eolo/eolo mini

**3 ZONES WITH PLENUM
IN POLYSTYRENE
"EOLO MINI" Ø125/150 mm**

**3 ZONES WITH PLENUM
IN POLYSTYRENE
"EOLO" Ø150/200 mm**



With **POLARIS 5X WI-FI** control unit with colour display - Wi-Fi, Alexa, Google Home



NOTE: FOR KIT COMPONENTS LIST SEE PAGE 30

N. 3 DISCOVERY 3X

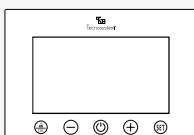

CODE	DESCRIPTION	COUPLING Ø	U.M.	Pieces per box
GAD400361	PROAIR PACK RF BLUE 3 - WITH PLENUM EOLO MINI IN POLYSTYRENE - WITH 3 CHRONOTERMOSTATS DISCOVERY 3X BACKLIT - WITH CONTROL UNIT POLARIS 5X - Ø125/150 mm	125/150 mm	PCS	1
GAD400362	PROAIR PACK RF BLUE 3 - WITH PLENUM EOLO IN POLYSTYRENE WITH 3 CHRONOTERMOSTATS DISCOVERY 3X BACKLIT - WITH CONTROL UNIT POLARIS 5X - Ø150/200 mm	150/200 mm	PCS	1

N. 3 MINI LED ASTRA



CODE	DESCRIPTION	COUPLING Ø	U.M.	Pieces per box
GAD400499	PROAIR PACK RF BLUE 3 - PLENUM IN POLYSTYRENE EOLO MINI - 3 THERMOSTATS MINI LED - WITH TROL UNIT POLARIS 5X - 125/150 mm	125/150 mm	PCS	1
GAD400500	PROAIR PACK RF BLUE 3 - PLENUM IN POLYSTYRENE EOLO WITH 3 THERMOSTATS MINI LED - WITH TROL UNIT POLARIS 5X - 150/200 mm	150/200 mm	PCS	1

N. 1 DISCOVERY 3X N. 2 ROOM PROBE LEM 3X



CODE	DESCRIPTION	COUPLING Ø	U.M.	Pieces per box
GAD400410	PROAIR PACK RF BLUE 3 - PLÉNUM EOLO MINI IN POLYSTYRENE - WITH 1 CHRONOTERMOSTAT DISCOVERY 3X BACKLIT + 2 ROOM PROBES AMBIENTE LEM 3X RF - WITH CONTROL UNIT POLARIS 5X - Ø125/150 mm	125/150 mm	PCS	1
GAD400411	PROAIR PACK RF BLUE 3 - WITH PLENUM EOLO IN POLYSTYRENE - WITH 1 CHRONOTERMOSTAT DISCOVERY 3X BACKLIT + 2 PROBES AMBIENTE LEM 3X RF - WITH CONTROL UNIT POLARIS 5X - Ø150/200 mm	150/200 mm	PCS	1

The plenum for duct units is included. **(Please, in time of order specify code of plenum, see from page 48)**



3 ZONES WITH INSULATED METAL SHEET PLENUM

With **POLARIS 5X WI-FI** control unit with colour display - Wi-Fi, Alexa, Google Home



NOTE: FOR KIT COMPONENTS LIST SEE PAGE 30

N. 3 DISCOVERY 3X

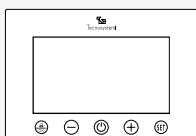

CODE	DESCRIPTION	DAMPERS Ø	U.M.	Pieces per box
GAD400381	PROAIR PACK RF BLUE 3 L - WITH 3 CHRONOTERMOSTATS DISCOVERY 3X BACKLIT - WITH CONTROL UNIT POLARIS 5X - Ø150 mm	150 mm	PCS	1
GAD400382	PROAIR PACK RF BLUE 3 L - WITH 3 CHRONOTERMOSTATS DISCOVERY 3X BACKLIT - WITH CONTROL UNIT POLARIS 5X - Ø200 mm	200 mm	PCS	1

N. 3 MINI LED ASTRA



CODE	DESCRIPTION	DAMPERS Ø	U.M.	Pieces per box
GAD400503	PROAIR PACK RF BLUE 3 L - 3 THERMOSTATS MINI LED - WITH TROL UNIT POLARIS 5X - 150 mm	150 mm	PCS	1
GAD400504	PROAIR PACK RF BLUE 3 L - 3 THERMOSTATS MINI LED - WITH TROL UNIT POLARIS 5X - 200 mm	200 mm	PCS	1

N. 1 DISCOVERY 3X N. 2 ROOM PROBE LEM 3X



CODE	DESCRIPTION	DAMPERS Ø	U.M.	Pieces per box
GAD400418	PROAIR PACK RF BLUE 3 L - WITH 1 CHRONOTERMOSTAT DISCOVERY 3X BACKLIT + 2 PROBES AMBIENTE LEM 3X RF - WITH CONTROL UNIT POLARIS 5X - Ø150 mm	150 mm	PCS	1
GAD400419	PROAIR PACK RF BLUE 3 L - WITH 1 CHRONOTERMOSTAT DISCOVERY 3X BACKLIT + 2 PROBES AMBIENTE LEM 3X RF - WITH CONTROL UNIT POLARIS 5X - Ø200 mm	200 mm	PCS	1

The plenum for duct units is included. **(Please, in time of order specify code of plenum, see from page 48)**

ProAirRF

pack 4 eolo/eolo mini

**4 ZONES WITH PLENUM
IN POLYSTYRENE
"EOLO MINI" Ø125/150 mm**

**4 ZONES WITH PLENUM
IN POLYSTYRENE
"EOLO" Ø150/200 mm**



With **POLARIS 5X WI-FI** control unit with colour display - Wi-Fi, Alexa, Google Home



NOTE: FOR KIT COMPONENTS LIST SEE PAGE 30

N. 4 DISCOVERY 3X

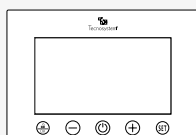

CODE	DESCRIPTION	COUPLING Ø	U.M.	Pieces per box
GAD400365	PROAIR PACK RF AMBRA 4 - WITH PLENUM EOLO MINI IN POLYSTYRENE - WITH 4 CHRONOTERMOSTATS DISCOVERY 3X BACKLIT - WITH CONTROL UNIT POLARIS 5X - Ø125/150 mm	125/150 mm	PCS	1
GAD400366	PROAIR PACK RF AMBRA 4 - WITH PLENUM EOLO IN POLYSTYRENE - WITH 4 CHRONOTERMOSTATS DISCOVERY 3X BACKLIT - WITH CONTROL UNIT POLARIS 5X - Ø150/200 mm	150/200 mm	PCS	1

N. 4 MINI LED ASTRA



CODE	DESCRIPTION	COUPLING Ø	U.M.	Pieces per box
GAD400507	PROAIR PACK RF AMBRA 4 - PLENUM IN POLYSTYRENE EOLO MINI - 4 THERMOSTATS MINI LED - WITH TROL UNIT POLARIS 5X - 125/150 mm	125/150 mm	PCS	1
GAD400508	PROAIR PACK RF AMBRA 4 - PLENUM IN POLYSTYRENE EOLO - 4 THERMOSTATS MINI LED - WITH TROL UNIT POLARIS 5X - 150/200 mm	150/200 mm	PCS	1

N. 1 DISCOVERY 3X N. 3 ROOM PROBE LEM 3X



CODE	DESCRIPTION	COUPLING Ø	U.M.	Pieces per box
GAD400412	PROAIR PACK RF AMBRA 4 - WITH PLENUM EOLO MINI IN POLYSTYRENE - WITH 1 CHRONOTERMOSTAT DISCOVERY 3X BACKLIT + 3 PROBES AMBIENTE LEM 3X RF - WITH CONTROL UNIT POLARIS 5X - Ø125/150 mm	125/150 mm	PCS	1
GAD400413	PROAIR PACK RF AMBRA 4 - WITH PLENUM EOLO IN POLYSTYRENE WITH 1 CHRONOTERMOSTAT DISCOVERY 3X BACKLIT + 3 PROBES AMBIENTE LEM 3X RF - WITH CONTROL UNIT POLARIS 5X - Ø150/200 mm	150/200 mm	PCS	1

The plenum for duct units is included. **(Please, in time of order specify code of plenum, see from page 48)**



4 ZONES WITH INSULATED METAL SHEET PLENUM

With **POLARIS 5X WI-FI** control unit with colour display - Wi-Fi, Alexa, Google Home

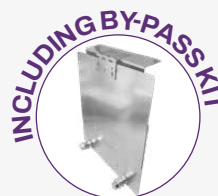

NOTE: FOR KIT COMPONENTS LIST SEE PAGE 30

N. 4 DISCOVERY 3X

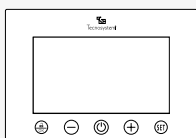

CODE	DESCRIPTION	DAMPERS Ø	U.M.	Pieces per box
GAD400383	PROAIR PACK RF AMBRA 4 L - WITH 4 CHRONOTERMOSTATS DISCOVERY 3X BACKLIT - WITH CONTROL UNIT POLARIS 5X - Ø150 mm	150 mm	PCS	1
GAD400384	PROAIR PACK RF AMBRA 4 L - WITH 4 CHRONOTERMOSTATS DISCOVERY 3X BACKLIT - WITH CONTROL UNIT POLARIS 5X - Ø200 mm	200 mm	PCS	1

N. 4 MINI LED ASTRA



CODE	DESCRIPTION	DAMPERS Ø	U.M.	Pieces per box
GAD400511	PROAIR PACK RF AMBRA 4 L - 4 THERMOSTATS MINI LED - WITH TROL UNIT POLARIS 5X - 150 mm	150 mm	PCS	1
GAD400512	PROAIR PACK RF AMBRA 4 L - 4 THERMOSTATS MINI LED - WITH TROL UNIT POLARIS 5X - 200 mm	200 mm	PCS	1

**N. 1 DISCOVERY 3X
N. 3 ROOM PROBE LEM 3X**

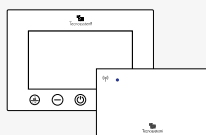

CODE	DESCRIPTION	DAMPERS Ø	U.M.	Pieces per box
GAD400420	PROAIR PACK RF AMBRA 4 L - WITH 1 CHRONOTERMOSTAT DISCOVERY 3X BACKLIT + 3 PROBES AMBIENTE LEM 3X RF - WITH CONTROL UNIT POLARIS 5X - Ø150mm	150 mm	PCS	1
GAD400421	PROAIR PACK RF AMBRA 4 L - WITH 1 CHRONOTERMOSTAT DISCOVERY 3X BACKLIT + 3 PROBES AMBIENTE LEM 3X RF - WITH CONTROL UNIT POLARIS 5X - Ø200 mm	200 mm	PCS	1

The plenum for duct units is included. **(Please, in time of order specify code of plenum, see from page 48)**



5 ZONES WITH PLENUM IN POLYSTYRENE
“EOLO” Ø150/200 mm

With **POLARIS 5X WI-FI** control unit with colour display - Wi-Fi, Alexa, Google Home



NOTE: FOR KIT COMPONENTS LIST SEE PAGE 30

N. 5 DISCOVERY 3X

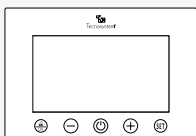

CODE	DESCRIPTION	COUPLING Ø	U.M.	Pieces per box
GAD400369	PLÉNUM EOLO IN POLYSTYRENE - WITH 5 CHRONOTERMOSTATS DISCOVERY 3X BACKLIT - WITH CONTROL UNIT POLARIS 5X - Ø150/200 mm	150/200mm	PCS	1

N. 5 MINI LED ASTRA



CODE	DESCRIPTION	COUPLING Ø	U.M.	Pieces per box
GAD400515	PROAIR PACK RF PINK 5 - PLENUM IN POLYSTYRENE EOLO - 5 THERMOSTATS MINI LED - WITH TROL UNIT POLARIS 5X - 150/200 mm	150/200mm	PCS	1

N. 1 DISCOVERY 3X N. 4 ROOM PROBE LEM 3X



CODE	DESCRIPTION	COUPLING Ø	U.M.	Pieces per box
GAD400414	PROAIR PACK RF PINK 5 - WITH PLENUM EOLO IN POLYSTYRENE - WITH 1 CHRONOTERMOSTAT DISCOVERY 3X BACKLIT + 4 PROBES AMBIENTE LEM 3X RF - WITH CONTROL UNIT POLARIS 5X - Ø150/200 mm	150/200mm	PCS	1

The plenum for duct units is included. **(Please, in time of order specify code of plenum, see from page 48)**



5 ZONES WITH INSULATED METAL SHEET PLENUM

With **POLARIS 5X WI-FI** control unit with colour display - Wi-Fi, Alexa, Google Home



NOTE: FOR KIT COMPONENTS LIST SEE PAGE 30

N. 5 DISCOVERY 3X

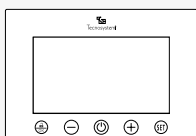

CODE	DESCRIPTION	DAMPERS Ø	U.M.	Pieces per box
GAD400391	PROAIR PACK RF PINK 5 L - WITH 5 CHRONOTERMOSTATS DISCOVERY 3X BACKLIT - WITH CONTROL UNIT POLARIS 5X - Ø150 mm	150 mm	PCS	1
GAD400392	PROAIR PACK RF PINK 5 L - WITH 5 CHRONOTERMOSTATS DISCOVERY 3X - WITH CONTROL UNIT POLARIS 5X - Ø200 mm	200 mm	PCS	1

N. 5 MINI LED ASTRA



CODE	DESCRIPTION	DAMPERS Ø	U.M.	Pieces per box
GAD400517	PROAIR PACK RF PINK 5 L - 5 THERMOSTATS MINI LED - WITH TROL UNIT POLARIS 5X - 150 mm	150 mm	PCS	1
GAD400518	PROAIR PACK RF PINK 5 L - 5 CRONOTHERMOSTATS DISCOVERY 3X - WITH TROL UNIT POLARIS 5X - 200 mm	200 mm	PCS	1

**N. 1 DISCOVERY 3X
N. 4 ROOM PROBE LEM 3X**



CODE	DESCRIPTION	DAMPERS Ø	U.M.	Pieces per box
GAD400422	PROAIR PACK RF PINK 5 L - WITH 1 CHRONOTERMOSTAT DISCOVERY 3X BACKLIT + 4 ROOM PROBES AMBIENTE LEM 3X RF - WITH CONTROL UNIT POLARIS 5X - Ø150 mm	150 mm	PCS	1
GAD400423	PROAIR PACK RF PINK 5 L - WITH 1 CHRONOTERMOSTAT DISCOVERY 3X BACKLIT + 4 ROOM PROBES AMBIENTE LEM 3X RF - WITH CONTROL UNIT POLARIS 5X - Ø200 mm	200 mm	PCS	1

The plenum for duct units is included. **(Please, in time of order specify code of plenum, see from page 48)**



6 ZONES WITH PLENUM IN POLYSTYRENE
“EOLO” Ø150/200 mm

With **POLARIS 5X WI-FI** control unit with colour display - Wi-Fi, Alexa, Google Home



SIDE DAMPER Ø150 ON DEMAND



NOTE: FOR KIT COMPONENTS LIST SEE PAGE 30

N. 6 DISCOVERY 3X

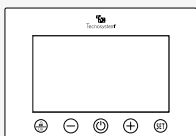

CODE	DESCRIPTION	COUPLING Ø	U.M.	Pieces per box
GAD400371	PROAIR PACK RF BROWN 6 - WITH PLENUM EOLO IN POLYSTYRENE - WITH 6 CHRONOTERMOSTATS DISCOVERY 3X BACKLIT - WITH CONTROL UNIT POLARIS 5X - Ø150/200 mm	150/200mm	PCS	1

N. 6 MINI LED ASTRA



CODE	DESCRIPTION	COUPLING Ø	U.M.	Pieces per box
GAD400521	PROAIR PACK RF BROWN 6 - PLENUM IN POLYSTYRENE EOLO - 6 THERMOSTATS MINI LED - WITH TROL UNIT POLARIS 5X - 150/200 mm	150/200mm	PCS	1

**N. 1 DISCOVERY 3X
 N. 5 ROOM PROBE LEM 3X**

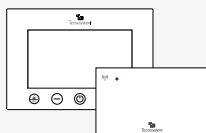

CODE	DESCRIPTION	COUPLING Ø	U.M.	Pieces per box
GAD400415	PROAIR PACK RF BROWN 6 - WITH PLENUM EOLO IN POLYSTYRENE - WITH 1 CHRONOTERMOSTAT DISCOVERY 3X BACKLIT + 5 ROOM PROBES AMBIENTE LEM 3X RF - WITH CONTROL UNIT POLARIS 5X - Ø150/200 mm	150/200mm	PCS	1

The plenum for duct units is included. **(Please, in time of order specify code of plenum, see from page 48)**



6 ZONES WITH INSULATED METAL SHEET PLENUM

With **POLARIS 5X WI-FI** control unit with colour display - Wi-Fi, Alexa, Google Home



NOTE: FOR KIT COMPONENTS LIST SEE PAGE 30

N. 6 DISCOVERY 3X

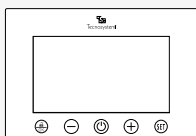

CODE	DESCRIPTION	DAMPERS Ø	U.M.	Pieces per box
GAD400395	PROAIR PACK RF BROWN 6 L - WITH 6 CHRONOTHERMOSTATS DISCOVERY 3X BACKLIT - WITH CONTROL UNIT POLARIS 5X - Ø150 mm	150 mm	PCS	1
GAD400396	PROAIR PACK RF BROWN 6 L - WITH 6 CHRONOTHERMOSTATS DISCOVERY 3X BACKLIT - WITH CONTROL UNIT POLARIS 5X - Ø200 mm	200 mm	PCS	1

N. 6 MINI LED ASTRA



CODE	DESCRIPTION	DAMPERS Ø	U.M.	Pieces per box
GAD400523	PROAIR PACK RF BROWN 6 L - 6 THERMOSTATS MINI LED - WITH TROL UNIT POLARIS 5X - 150 mm	150 mm	PCS	1
GAD400524	PROAIR PACK RF BROWN 6 L - 6 THERMOSTATS MINI LED - WITH TROL UNIT POLARIS 5X - 200 mm	200 mm	PCS	1

**N. 1 DISCOVERY 3X
N. 5 ROOM PROBE LEM 3X**



CODE	DESCRIPTION	DAMPERS Ø	U.M.	Pieces per box
GAD400424	PROAIR PACK RF BROWN 6 L - WITH 1 CHRONOTHERMOSTAT DISCOVERY 3X BACKLIT + 5 PROBES AMBIENTE LEM 3X RF - WITH CONTROL UNIT POLARIS 5X - Ø150 mm	150 mm	PCS	1
GAD400425	PROAIR PACK RF BROWN 6 L - WITH 1 CHRONOTHERMOSTAT DISCOVERY 3X BACKLIT + 5 PROBES AMBIENTE LEM 3X RF - WITH CONTROL UNIT POLARIS 5X - Ø200 mm	200 mm	PCS	1

The plenum for duct units is included. **(Please, in time of order specify code of plenum, see from page 48)**

CONFIGURE YOUR PROAIR PACK



 On the website [tecnosystemi.com](https://www.tecnosystemi.com)

Automatically generates **quotations** and **datasheets** for the chosen products

Caution: the configurator includes only ProAir Pack products



CONFIGURE YOUR PROAIR PACK HYDRONIC

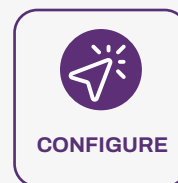

 On the website [tecnosystemi.com](https://www.tecnosystemi.com)

Automatically generates **quotations** and **datasheets** for the chosen products



CONFIGURE YOUR SYSTEM WITH ALL THE PROAIR SYSTEM LOOSE ELEMENTS



 On the website [tecnosystemi.com](https://www.tecnosystemi.com)

Automatically generates **quotations** and **datasheets** for the chosen products



CONTENTS OF "PROAIR-CAB" PACK KITS

All proair packs are tested and configured, ready to be installed.
Matching between chrono-thermostats and dampers is identified by numbering.

RADIO PACK CAB PLENUM EOLO / EOLO MINI



PAG. 48

1 PC.

Sintered polystyrene delivery plenum for ducted units (specify the plenum code when ordering). Mechanical bypass kit to be fastened to right or left side of plenum (includes fastening ring nut and counterweight)

PROAIR PACK CAB INSULATED METAL SHEET / POLYURETHANE FOAM (PAL)



PAG. 48

1 PC.

Insulated inlet plenum for ducted units (specify the plenum code when ordering). Polyurethane foam pal available on request



PAG. 10-11

1 PC.

Polaris 5x control unit with colour display, incorporated protocols and app, alexa e google home



PAG. 10-11

1 PC.

Polaris 5x control unit with colour display, incorporated protocols and app, alexa e google home



PAG. 14-18

ACCORDING TO THE QUANTITY OF ZONES
"Stealth 3x" chrono-thermostat



PAG. 14-18

ACCORDING TO THE QUANTITY OF ZONES
"Stealth 3x" chrono-thermostat



ACCORDING TO THE QUANTITY OF ZONES
Motorized dampers integrated on plenum

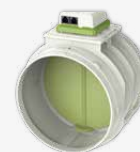

ACCORDING TO THE QUANTITY OF ZONES
Motorized dampers integrated on plenum

ATTENTION: a clean on/of contact can be used if an infrared receiver is not available (check with the ducted manufacturer whether the machine needs a suitable interface).

ProAirCAB

pack 2 eolo

2 ZONES WITH PLENUM IN POLYSTYRENE
"EOLO" Ø150/200 mm



With **POLARIS 5X WI-FI** control unit with colour display - Wi-Fi, Alexa, Google Home



NOTE: FOR KIT COMPONENTS LIST SEE PAGE 42

N. 2
STEALTH 3X

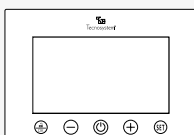

CODE	DESCRIPTION	COUPLING Ø	U.M.	Pieces per box
GAD400373	PROAIR PACK CAB GREEN 2 - WITH PLENUM EOLO IN POLYSTYRENE - WITH 2 CHRONOTERMOSTATS STEALTH 3X - WITH CONTROL UNIT POLARIS 5X - Ø150/200 mm	150/200mm	PCS	1

The plenum for duct units is included.
(Please, in time of order specify code of plenum, see from page 48)

ProAirCAB

pack 2L

2 ZONES WITH INSULATED METAL SHEET PLENUM



With **POLARIS 5X WI-FI** control unit with colour display - Wi-Fi, Alexa, Google Home



NOTE: FOR KIT COMPONENTS LIST SEE PAGE 42

N. 2
STEALTH 3X

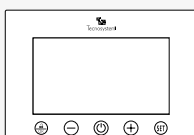

CODE	DESCRIPTION	DAMPERS Ø	U.M.	Pieces per box
GAD400399	PROAIR PACK CAB GREEN 2 - WITH 2 CHRONOTERMOSTATSSTEALTH 3X - WITH CONTROL UNIT POLARIS 5X - Ø150 mm	150 mm	PCS	1
GAD400400	PROAIR PACK CAB GREEN 2 - WITH 2 CHRONOTERMOSTATSSTEALTH 3X - WITH CONTROL UNIT POLARIS 5X - Ø200 mm	200 mm	PCS	1

The plenum for duct units is included. (Please, in time of order specify code of plenum, see from page 48)

ProAirCAB

pack 3 eolo/eolo mini

**3 ZONES WITH PLENUM
IN POLYSTYRENE
"EOLO MINI" Ø125/150 mm**

**3 ZONES WITH PLENUM
IN POLYSTYRENE
"EOLO" Ø150/200 mm**





With **POLARIS 5X WI-FI** control unit with colour display - Wi-Fi, Alexa, Google Home

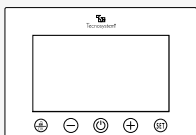

NOTE: FOR KIT COMPONENTS LIST SEE PAGE 42

**N. 3
STEALTH 3X**



CODE	DESCRIPTION	COUPLING Ø	U.M.	 Pieces per box
GAD400374	PROAIR PACK CAB SILVER 3 - WITH PLENUM EOLO MINI IN POLYSTYRENE - WITH 3 CHRONOTERMOSTATS STEALTH 3X - WITH CONTROL UNIT POLARIS 5X - Ø125/150 mm	125/150mm	PCS	1
GAD400375	PROAIR PACK CAB SILVER 3 - WITH PLENUM EOLO IN POLYSTYRENE - WITH 3 CHRONOTERMOSTATS STEALTH 3X - WITH CONTROL UNIT POLARIS 5X - Ø150/200 mm	150/200mm	PCS	1

The plenum for duct units is included. **(Please, in time of order specify code of plenum, see from page 48)**

ProAirCAB

pack 3L

**3 ZONES WITH INSULATED
METAL SHEET PLENUM**





With **POLARIS 5X WI-FI** control unit with colour display - Wi-Fi, Alexa, Google Home

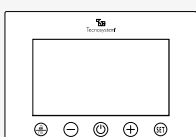

NOTE: FOR KIT COMPONENTS LIST SEE PAGE 42

**N. 3
STEALTH 3X**



CODE	DESCRIPTION	DAMPERS Ø	U.M.	 Pieces per box
GAD400401	PROAIR PACK CAB SILVER 3L - WITH 3 CHRONOTERMOSTATS STEALTH 3X - WITH CONTROL UNIT POLARIS 5X - Ø150 mm	150 mm	PCS	1
GAD400402	PROAIR PACK CAB SILVER 3L - WITH 3 CHRONOTERMOSTATS STEALTH 3X - WITH CONTROL UNIT POLARIS 5X - Ø200 mm	200 mm	PCS	1

The plenum for duct units is included. **(Please, in time of order specify code of plenum, see from page 48)**

ProAirCAB

pack 4 eolo/eolo mini

**4 ZONES WITH PLENUM
IN POLYSTYRENE**
"EOLO MINI" Ø125/150 mm

**4 ZONES WITH PLENUM
IN POLYSTYRENE**
"EOLO" Ø150/200 mm



With **POLARIS 5X WI-FI** control unit with colour display - Wi-Fi, Alexa, Google Home



NOTE: FOR KIT COMPONENTS LIST SEE PAGE 42

**N. 4
STEALTH 3X**

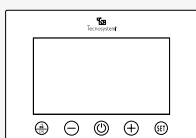

CODE	DESCRIPTION	DAMPERS Ø	U.M.	Pieces per box
GAD400376	PROAIR PACK CAB LILLA 4 - WITH PLENUM EOLO MINI IN POLYSTYRENE - WITH 4 CHRONOTERMOSTATS STEALTH 3X - WITH CONTROL UNIT POLARIS 5X - Ø125/150 mm	125/150 mm	PCS	1
GAD400377	PROAIR PACK CAB LILLA 4 - WITH PLENUM EOLO IN POLYSTYRENE - WITH 4 CHRONOTERMOSTATS STEALTH 3X - WITH CONTROL UNIT POLARIS 5X - Ø150/200 mm	150/200 mm	PCS	1

The plenum for duct units is included. (Please, in time of order specify code of plenum, see from page 48)

ProAirCAB

pack 4L

**4 ZONES WITH INSULATED
METAL SHEET PLENUM**



With **POLARIS 5X WI-FI** control unit with colour display - Wi-Fi, Alexa, Google Home



NOTE: FOR KIT COMPONENTS LIST SEE PAGE 42

**N. 4
STEALTH 3X**

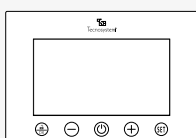

CODE	DESCRIPTION	DAMPERS Ø	U.M.	Pieces per box
GAD400403	PROAIR PACK CAB LILLA 4 L - WITH 4 CHRONOTERMOSTATSSTEALTH 3X - WITH CONTROL UNIT POLARIS 5X - Ø150 mm	150 mm	PCS	1
GAD400404	PROAIR PACK CAB LILLA 4 L - WITH 4 CHRONOTERMOSTATSSTEALTH 3X - WITH CONTROL UNIT POLARIS 5X - Ø200 mm	200 mm	PCS	1

The plenum for duct units is included. (Please, in time of order specify code of plenum, see from page 48)

ProAirCAB

pack 5 eolo



**5 ZONES WITH WITH PLENUM
IN POLYSTYRENE "EOLO" Ø150/200 mm**

With **POLARIS 5X WI-FI** control unit with colour display - Wi-Fi, Alexa, Google Home

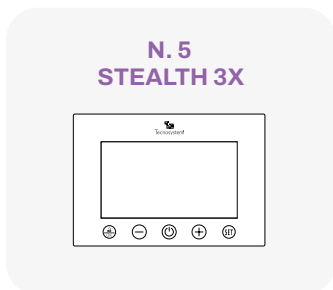

CODE	DESCRIPTION	COUPLING Ø	U.M.	Pieces per box
GAD400378	PROAIR PACK CAB ORANGE 5 - WITH PLENUM EOLO IN POLYSTYRENE - WITH 5 CHRONOTHERMOSTATS STEALTH 3X - WITH CONTROL UNIT POLARIS 5X - Ø150/200 mm	150/200mm	PCS	1

The plenum for duct units is included.
(Please, in time of order specify code of plenum, see from page 48)

ProAirCAB

pack 5L



**5 ZONES WITH INSULATED
METAL SHEET PLENUM**

With **POLARIS 5X WI-FI** control unit with colour display - Wi-Fi, Alexa, Google Home

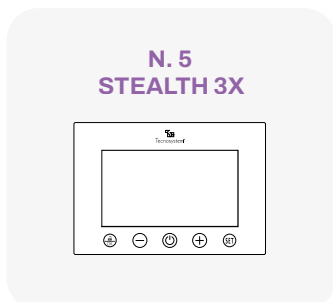

CODE	DESCRIPTION	DAMPERS Ø	U.M.	Pieces per box
GAD400405	PROAIR PACK CAB ORANGE 5 L - WITH 5 CHRONOTHERMOSTATSSTEALTH 3X - WITH CONTROL UNIT POLARIS 5X - Ø150 mm	150 mm	PCS	1
GAD400406	PROAIR PACK CAB ORANGE 5 L - WITH 5 CHRONOTHERMOSTATSSTEALTH 3X - WITH CONTROL UNIT POLARIS 5X - Ø200 mm	200 mm	PCS	1

The plenum for duct units is included.
(Please, in time of order specify code of plenum, see from page 48)



6 ZONES WITH INSULATED METAL SHEET PLENUM

With **POLARIS 5X WI-FI** control unit with colour display - Wi-Fi, Alexa, Google Home

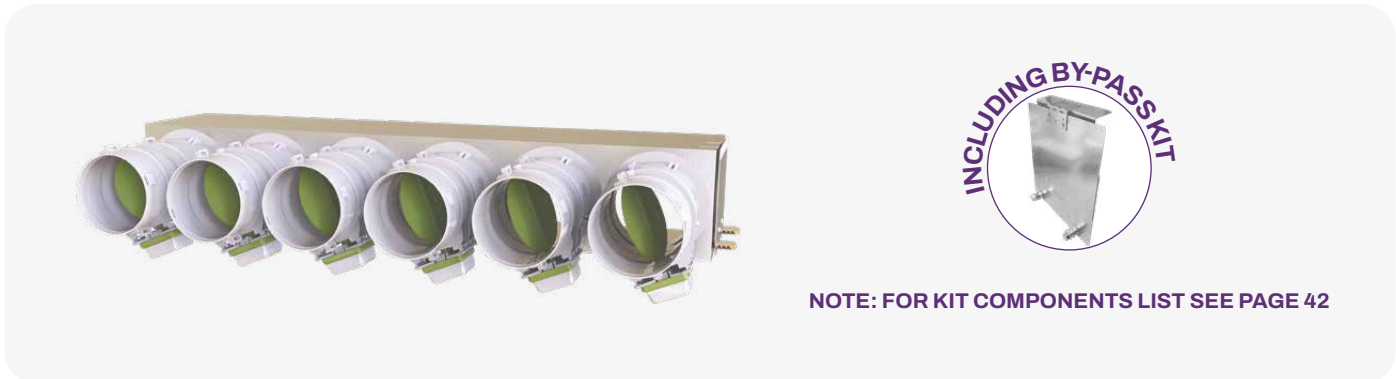

NOTE: FOR KIT COMPONENTS LIST SEE PAGE 42

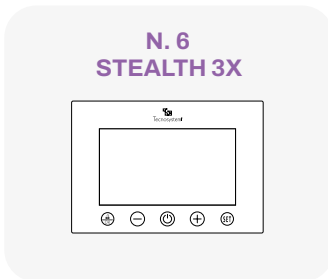

CODE	DESCRIPTION	COUPLING Ø	U.M.	Pieces per box
GAD400407	PROAIR PACK CAB BLACK 6 L - WITH 6 CHRONOTERMOSTATSSTEALTH 3X - WITH CONTROL UNIT POLARIS 5X - Ø150 mm	150 mm	PCS	1
GAD400408	PROAIR PACK CAB BLACK 6 L - WITH 6 CHRONOTERMOSTATSSTEALTH 3X - WITH CONTROL UNIT POLARIS 5X - Ø200 mm	200 mm	PCS	1

The plenum for duct units is included. **(Please, in time of order specify code of plenum, see from page 48)**



BIM TECHNOLOGY

Tecosystemi provides professionals in the mechanical, architectural, and structural design sectors with 3D models of our Proair system for use in BIM (Building Information Modeling).

The components of our PROAIR system can be downloaded free of charge from the following platform:



THE RANGE OF PLENUM FOR DUCTED AIR CONDITIONING UNITS MORE COMPLETE AND AVAILABLE PRESENT ON THE MARKET

The cost of the plenum of the ducted unit* is included in the price of the Proair Pack



IDENTIFY THE BRAND AND MODEL OF YOUR DUCTED MACHINE

Our catalogue contains all the makes and models of ducted air conditioning units currently manu-factured



Material availability within 5 working days from the order entry date.



In some cases, a supply air plenum made of chipboard may be proposed.

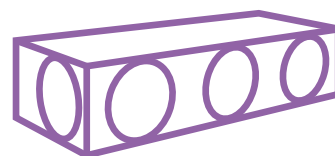

*PAL plenum available on request.

- The information on the composition of each plenum is purely indicative and not binding. It is necessary to check that all elements that make up the plenum are compatible with the design specifications of the system to be built.
- TECNOSYSTEMI S.P.A SOCIETÀ BENEFIT accepts no liability for negligent or improper use of the product.
- The products in this catalogue are designed and manufactured exclusively to our specifications.
- For further information, please contact the technical department.

* Sheet metal plenums are pre-drilled.

* Collars are not included in the supply: for collars, see pages 237-238 Project Wind

COMPLETE KITS INCLUDING ALL COMPONENTS FOR AIR DISTRIBUTION

THE PAGES REFER TO THE PROJECT WIND CATALOGUES

DAIKIN	page 106		page 138
Panasonic	page 108		page 138
TOSHIBA	page 110		page 138
	page 114	Hisense	page 140
SAMSUNG	page 116	EMMETI	page 140
	page 118	UNICAL	page 140
HITACHI	page 120	IDEMA	page 142
Haier	page 120	BAXI	page 142
	page 122		page 142
	page 124	CLIMAVENETA	page 144
	page 124	VAILLANT	page 144
	page 126	MAXA	page 144
	page 126	STELBI	page 146
AERMEC	page 128		page 146
	page 132	TOYOTOMI	page 146
Midea	page 132		page 148
	page 134	CLIMA AUX	page 148
VIESSMANN	page 134	BOSCH	page 148
	page 136	FERROLI	page 150
HOKKAIDO	page 136	IMMERGAS	page 150
		RIELLO	page 150

CONFIGURE YOUR PLENUM



CONFIGURE YOUR PROAIR PACK



 On the website [tecnosystemi.com](https://www.tecnosystemi.com)

Automatically generates **quotations** and **datasheets** for the chosen products.

ProAir 
pack RF-eolo

ProAir 
pack RF-L

ProAir 
pack CAB-eolo

ProAir 
pack CAB-L

The "Kit Rapid" are designed for ProAir pack ventilation systems.

When creating a ducted air conditioning system, the pre-packaged kits facilitate the customer in choosing the items necessary for the distribution of air in the individual environments, **without the possibility of error.**

The "Kit Rapid" are available for the proair pack systems with **2 - 3 - 4 - 5 - 6 zones** with circular connections of Ø 125 / 150 / 200 mm. The possibility of choosing between delivery nozzles with adjustable flaps, with 15° inclined flaps and with linear diffusers with 2 slots, provides everything needed to create and complete the installation of the ducted unit with high quality products, with every detail covered from a technical, functional and aesthetic point of view.

The regulation of the temperature and air flow of the single zone is managed by the ProAir pack system chrono thermostats that are used to achieve the maximum performance and optimum comfort inside homes or offices.

ATTENTION: the plenum is included in the ProAir Pack.

pag. 51-52

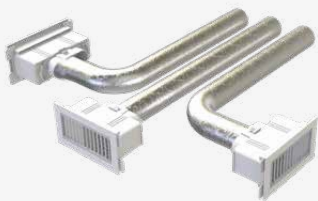

KIT RAPID with Ø 125 connections and grilles with anti-condensation white ABS plastic

pag. 52-54

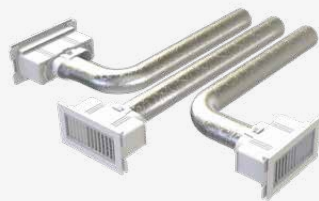

KIT RAPID with Ø 150 connections and grilles with anti-condensation white ABS plastic

pag. 55-57



KIT RAPID with Ø 200 connections and grilles with anti-condensation white ABS plastic

pag. 58-59

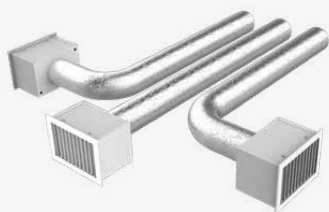

KIT RAPID with Ø 125 connections and adjustable adjustable deflectors

pag. 59-61

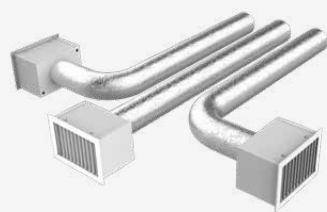

KIT RAPID with Ø 150 connections and adjustable adjustable deflectors

pag. 62-64

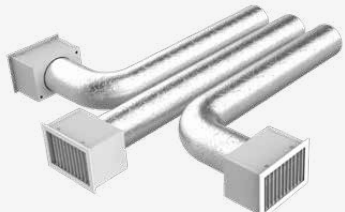

KIT RAPID with Ø 200 connections and adjustable adjustable deflectors

pag. 64-66

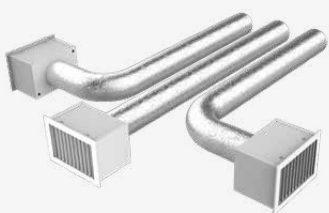

KIT RAPID with Ø 150 connections and adjustable deflectors

pag. 67-69

NEW

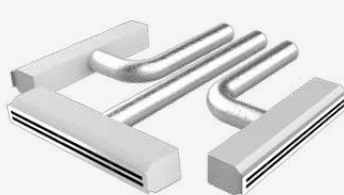

KIT RAPID with Ø 150 connections and linear diffusers

WITH Ø125 CONNECTIONS, GRILLE IN ABS PLASTIC AND ADJUSTABLE DEFLECTORS

Ø125

 **KIT RAPID FOR PROAIR PACK 2 ZONES WITH Ø 125 CONNECTIONS AND GRILLES IN ANTI-CONDENSATION ABS PLASTIC WITH ADJUSTABLE FLAPS**

THE KIT CONSISTS OF:

- 2 ABS plastic supply grilles, installation hole 300 x 100 mm, outer size 334 x 134 mm COD. PWD100016
- 2 insulated plenums with rear coupling for grille (300 x 100) COD. PWD402431
- 1 double-wall aluminium flexible hose Ø 127 mm 10 m COD. 11152127
- 1 white aluminium intake grille with filter installation hole 600 x 400 mm, external measurement 632 x 432 mm COD. WB11161525

 **KIT RAPID POUR COMPLÉTER PROAIR PACK 2 ZONES AVEC FIXATIONS Ø 125 ET GRILLES EN PLASTIQUE ABS ANTI-CONDENSATION À AILETTES RÉGLABLES**

LE KIT SE COMPOSE DE:

- 2 grilles de refoulement en plastique ABS, trou d'installation 300 x 100 mm, dimension extérieure 334 x 134 mm CODE PWD100016
- 2 plénums isolés avec fixation arrière pour grille (300 x 100) CODE PWD402431
- 1 tuyau flexible en aluminium double paroi Ø 127 mm de 10 m CODE 11152127
- 1 grille de récupération en aluminium blanc avec filtre à trou d'installation 600 x 400 mm, taille extérieure 632 x 432 mm code WB11161525

 **KIT RAPID ALS ERGÄNZUNG FÜR PROAIR PACK 2 ZONEN MIT ANSCHLÜSSEN Ø 125 UND LUFTGITTERN AUS ABS-KUNSTSTOFF, KONDENSATSCHUTZ MIT VERSTELLBAREN LAMELLEN**

DER BAUSATZ BESTEHT AUS:

- 2 Zuluftgitter aus ABS-Kunststoff, Einbauöffnung 300 x 100 mm, Außenmaß 334 x 134 mm CODE PWD100016
- 2 gedämmte Plenums mit hinterem Anschluss für Luftgitter (300 x 100) CODE PWD402431
- 1x 10 m Ø 127 mm Aluminium-Doppelwandschlauch CSB. 11152127
- 1 Ansauggitter aus Aluminium weiß lackiert mit Filter, Einbauöffnung 600 x 400 Außenmaß 632 x 432 mm COD. WB11161525



CODE	DESCRIPTION	U.M.	 Pieces per box
GAC500014	KIT RAPID 2 ZONES - (COUPLING Ø 125 MM)	PCS	1

 **KIT RAPID FOR PROAIR PACK 3 ZONES WITH Ø 125 CONNECTIONS AND GRILLES IN ANTI-CONDENSATION ABS PLASTIC WITH ADJUSTABLE FLAPS**

THE KIT CONSISTS OF:

- 3 ABS plastic supply grilles, installation hole 300 x 100 mm, outer size 334 x 134 mm COD. PWD100016
- 3 insulated plenums with rear coupling for grille (300 x 100) COD. PWD402431
- 1 double-wall aluminium flexible hose Ø 127 mm 10 m COD. 11152127
- 1 white aluminium intake grille with filter installation hole 600 x 400 mm, external measurement 632 x 432 mm COD. WB11161525

 **KIT RAPID POUR COMPLÉTER PROAIR PACK 3 ZONES AVEC FIXATIONS Ø 125 ET GRILLES EN PLASTIQUE ABS ANTI-CONDENSATION À AILETTES RÉGLABLES**

LE KIT SE COMPOSE DE:

- 3 grilles de refoulement en plastique ABS, trou d'installation 300 x 100 mm, dimension extérieure 334 x 134 mm CODE PWD100016
- 3 plénums isolés avec fixation arrière pour grille (300 x 100) CODE PWD402431
- 1 tuyau flexible en aluminium double paroi Ø 127 mm de 10 m CODE 11152127
- 1 grille de récupération en aluminium blanc avec filtre à trou d'installation 600 x 400 mm, taille extérieure 632 x 432 mm code WB11161525

 **KIT RAPID ALS ERGÄNZUNG FÜR PROAIR PACK 3 ZONEN MIT ANSCHLÜSSEN Ø 125 UND LUFTGITTERN AUS ABS-KUNSTSTOFF, KONDENSATSCHUTZ MIT VERSTELLBAREN LAMELLEN**

DER BAUSATZ BESTEHT AUS:

- 3 Zuluftgitter aus ABS-Kunststoff, Einbauöffnung 300 x 100 mm, Außenmaß 334 x 134 mm CODE PWD100016
- 3 gedämmte Plenums mit hinterem Anschluss für Luftgitter (300 x 100) CODE PWD402431
- 1x 10 m Ø 127 mm Aluminium-Doppelwandschlauch CSB. 11152127
- 1 Ansauggitter aus Aluminium weiß lackiert mit Filter, Einbauöffnung 600 x 400 Außenmaß 632 x 432 mm COD. WB11161525

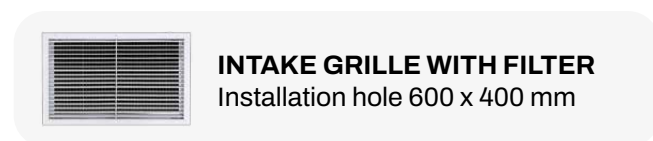
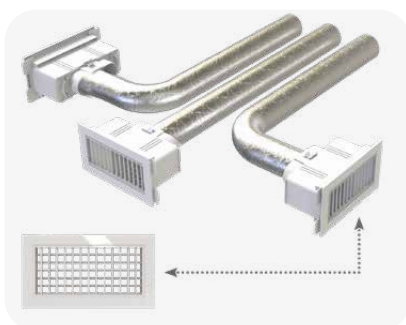

[Customisable on request](#)

CODE	DESCRIPTION	U.M.	 Pieces per box
GAC500015	KIT RAPID 3 ZONES - (COUPLING Ø 125 MM)	PCS	1

**KIT RAPID FOR PROAIR
PACK 4 ZONES WITH Ø 125
CONNECTIONS AND GRILLES
IN ANTI-CONDENSATION ABS
PLASTIC WITH ADJUSTABLE
FLAPS**

THE KIT CONSISTS OF:

- 4 ABS plastic supply grilles, installation hole 300 x 100 mm, outer size 334 x 134 mm COD. PWD100016
- 4 insulated plenums with rear coupling for grille (300 x 100) COD. PWD402431
- 1 double-wall aluminium flexible hose Ø 127 mm 10 m COD. 11152127
- 1 white aluminium intake grille with filter installation hole 600 x 400 mm, external measurement 632 x 432 mm COD. WB11161525

**KIT RAPID POUR COMPLÉTER
PROAIR PACK 4 ZONES AVEC
FIXATIONS Ø 125 ET GRILLES
EN PLASTIQUE ABS ANTI-
CONDENSATION À AILETTES
RÉGLABLES**

LE KIT SE COMPOSE DE:

- 4 grilles de refoulement en plastique ABS, trou d'installation 300 x 100 mm, dimension extérieure 334 x 134 mm CODE PWD100016
- 4 pléniums isolés avec fixation arrière pour grille (300 x 100) CODE PWD402431
- 1 tuyau flexible en aluminium double paroi Ø 127 mm de 10 m CODE 11152127
- 1 grille de récupération en aluminium blanc avec filtre à trou d'installation 600 x 400 mm, taille extérieure 632 x 432 mm code WB11161525

**KIT RAPID ALS ERGÄNZUNG
FÜR PROAIR PACK 4 ZONEN
MIT ANSCHLÜSSEN Ø 125
UND LUFTGITTERN AUS
ABS-KUNSTSTOFF, KONDEN-
SATSCHUTZ MIT VERSTELL-
BAREN LAMELLEN**

DER BAUSATZ BESTEHT AUS:

- 4 Zuluftgitter aus ABS-Kunststoff, Einbauöffnung 300 x 100 mm, Außenmaß 334 x 134 mm CODE PWD100016
- 4 gedämmte Plenums mit hinterem Anschluss für Luftgitter (300 x 100) CODE PWD402431
- 1x 10 m Ø 127 mm Aluminium-Doppelwandschlauch CSB. 11152127
- 1 Ansauggitter aus Aluminium weiß lackiert mit Filter, Einbauöffnung 600 x 400 Außenmaß 632 x 432 mm COD. WB11161525

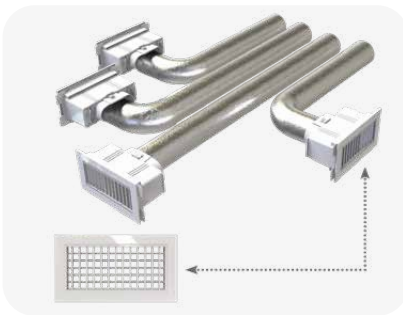

DATASHEET



INTAKE GRILLE WITH FILTER

Installation hole 600 x 400 mm

[Customisable on request](#)

CODE	DESCRIPTION	U.M.	Pieces per box
GAC500016	KIT RAPID 4 ZONES - (COUPLING Ø 125 MM)	PCS	1

**WITH Ø150 CONNECTIONS, GRILLE IN ABS PLASTIC
AND ADJUSTABLE DEFLECTORS**

Ø150

**KIT RAPID FOR PROAIR
PACK 2 ZONES WITH Ø 150
CONNECTIONS AND GRILLES
IN ANTI-CONDENSATION ABS
PLASTIC WITH ADJUSTABLE
FLAPS**

THE KIT CONSISTS OF:

- 2 ABS plastic supply grilles, installation hole 300 x 150 mm, outer size 334 x 184 mm COD. PWD100014
- No. 2 insulated plenums with rear connection for grille (300 x 150), CODE PWD402433
- 1 double-wall aluminium flexible hose Ø 152 mm 10 m COD. 11152152
- 1 white aluminium intake grille with filter installation hole 600 x 400 mm, external measurement 632 x 432 mm COD. WB11161525

**KIT RAPID POUR COMPLÉTER
PROAIR PACK 2 ZONES AVEC
FIXATIONS Ø 150 ET GRILLES
EN PLASTIQUE ABS ANTI-
CONDENSATION À AILETTES
RÉGLABLES**

LE KIT SE COMPOSE DE:

- 2 grilles de refoulement en plastique ABS, trou d'installation 300 x 150 mm, dimension extérieure 334 x 184 mm CODE PWD100014
- N° 2 pléniums isolés avec raccord arrière pour bouche (300 x 150), CODE PWD402433
- 1 tuyau flexible en aluminium double paroi Ø 152 mm de 10 m CODE 11152152
- 1 grille de récupération en aluminium blanc avec filtre à trou d'installation 600 x 400 mm, taille extérieure 632 x 432 mm code WB11161525

**KIT RAPID ALS ERGÄNZUNG
FÜR PROAIR PACK 2 ZONEN
MIT ANSCHLÜSSEN Ø 150
UND LUFTGITTERN AUS
ABS-KUNSTSTOFF, KONDEN-
SATSCHUTZ MIT VERSTELL-
BAREN LAMELLEN**

DER BAUSATZ BESTEHT AUS:

- 2 Zuluftgitter aus ABS-Kunststoff, Einbauöffnung 300 x 150 mm, Außenmaß 334 x 184 mm CODE PWD100014
- 2 isolierte Plenums mit rückseitigem Anschluss für Auslassgitter (300 x 150), CODE PWD402433
- 1x 10 m Ø 152 mm Aluminium-Doppelwandschlauch CSB. 11152152
- 1 Ansauggitter aus Aluminium weiß lackiert mit Filter, Einbauöffnung 600 x 400 Außenmaß 632 x 432 mm COD. WB11161525

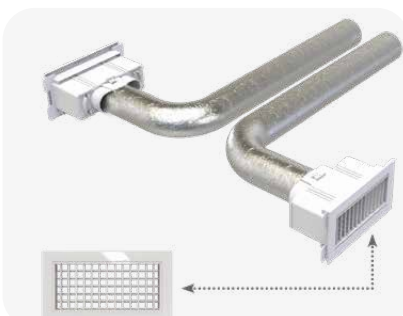

DATASHEET



INTAKE GRILLE WITH FILTER

Installation hole 600 x 400 mm

[Customisable on request](#)

CODE	DESCRIPTION	U.M.	Pieces per box
GAC500017	KIT RAPID 2 ZONES - (COUPLING Ø 150 MM)	PCS	1

KIT RAPID FOR PROAIR PACK 3 ZONES WITH Ø 150 CONNECTIONS AND GRILLES IN ANTI-CONDENSATION ABS PLASTIC WITH ADJUSTABLE FLAPS

THE KIT CONSISTS OF:

- 3 ABS plastic supply grilles, installation hole 300 x 150 mm, outer size 334 x 184 mm COD. PWD100014
- 3 insulated plenums with rear connection for outlet (300 x 150) CODE PWD402433
- 1 double-wall aluminium flexible hose Ø 152 mm 10 m COD. 11152152
- 1 white aluminium intake grille with filter installation hole 600 x 400 mm, external measurement 632 x 432 mm COD. WB11161525

KIT RAPID POUR COMPLÉTER PROAIR PACK 3 ZONES AVEC FIXATIONS Ø 150 ET GRILLES EN PLASTIQUE ABS ANTI-CONDENSATION À AILETTES RÉGLABLES

LE KIT SE COMPOSE DE:

- 3 grilles de refoulement en plastique ABS, trou d'installation 300 x 150 mm, dimension extérieure 334 x 184 mm CODE PWD100014
- 3 plenums isolés avec raccord arrière pour bouche (300 x 150) CODE PWD402433
- 1 tuyau flexible en aluminium double paroi Ø 152 mm de 10 m CODE 11152152
- 1 grille de récupération en aluminium blanc avec filtre à trou d'installation 600 x 400 mm, taille extérieure 632 x 432 mm code WB11161525

KIT RAPID ALS ERGÄNZUNG FÜR PROAIR PACK 3 ZONEN MIT ANSCHLÜSSEN Ø 150 UND LUFTGITTERN AUS ABS-KUNSTSTOFF, KONDENSATSCHUTZ MIT VERSTELLBAREN LAMELLEN

DER BAUSATZ BESTEHT AUS:

- 3 Zuluftgitter aus ABS-Kunststoff, Einbauöffnung 300 x 150 mm, Außenmaß 334 x 184 mm CODE PWD100014
- 3 isolierte Plenums mit Rückanschluss für Auslass (300 x 150) CODE PWD402433
- 1x 10 m Ø 152 mm Aluminium-Doppelwandschlauch CSB. 11152152
- 1 Ansauggitter aus Aluminium weiß lackiert mit Filter, Einbauöffnung 600 x 400 Außenmaß 632 x 432 mm COD. WB11161525

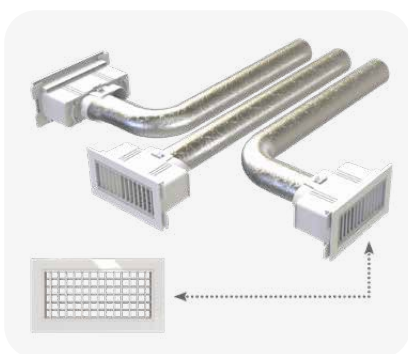

INTAKE GRILLE WITH FILTER
Installation hole 600 x 400 mm

[Customisable on request](#)

CODE	DESCRIPTION	U.M.	Pieces per box
GAC500018	KIT RAPID 3 ZONES - (COUPLING Ø 150 MM)	PCS	1

KIT RAPID FOR PROAIR PACK 4 ZONES WITH Ø 150 CONNECTIONS AND GRILLES IN ANTI-CONDENSATION ABS PLASTIC WITH ADJUSTABLE FLAPS

THE KIT CONSISTS OF:

- 4 ABS plastic supply grilles, installation hole 300 x 150 mm, outer size 334 x 184 mm COD. PWD100014
- 4 insulated plenums with rear connection for outlet (300 x 150) CODE PWD402433
- 1 double-wall aluminium flexible hose Ø 152 mm 10 m COD. 11152152
- 1 white aluminium intake grille with filter installation hole 600 x 400 mm, external measurement 632 x 432 mm COD. WB11161525

KIT RAPID POUR COMPLÉTER PROAIR PACK 4 ZONES AVEC FIXATIONS Ø 150 ET GRILLES EN PLASTIQUE ABS ANTI-CONDENSATION À AILETTES RÉGLABLES

LE KIT SE COMPOSE DE:

- 4 grilles de refoulement en plastique ABS, trou d'installation 300 x 150 mm, dimension extérieure 334 x 184 mm CODE PWD100014
- 4 plenums isolés avec raccord arrière pour bouche (300 x 150) CODE PWD402433
- 1 tuyau flexible en aluminium double paroi Ø 152 mm de 10 m CODE 11152152
- 1 grille de récupération en aluminium blanc avec filtre à trou d'installation 600 x 400 mm, taille extérieure 632 x 432 mm code WB11161525

KIT RAPID ALS ERGÄNZUNG FÜR PROAIR PACK 4 ZONEN MIT ANSCHLÜSSEN Ø 150 UND LUFTGITTERN AUS ABS-KUNSTSTOFF, KONDENSATSCHUTZ MIT VERSTELLBAREN LAMELLEN

DER BAUSATZ BESTEHT AUS:

- 4 Zuluftgitter aus ABS-Kunststoff, Einbauöffnung 300 x 150 mm, Außenmaß 334 x 184 mm CODE PWD100014
- 4 isolierte Plenums mit Rückanschluss für Auslass (300 x 150) CODE PWD402433
- 1x 10 m Ø 152 mm Aluminium-Doppelwandschlauch CSB. 11152152
- 1 Ansauggitter aus Aluminium weiß lackiert mit Filter, Einbauöffnung 600 x 400 Außenmaß 632 x 432 mm COD. WB11161525

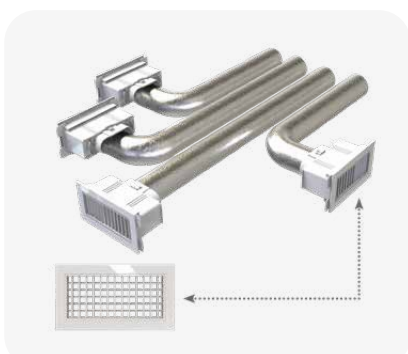

INTAKE GRILLE WITH FILTER
Installation hole 600 x 400 mm

[Customisable on request](#)

CODE	DESCRIPTION	U.M.	Pieces per box
GAC500019	KIT RAPID 4 ZONES - (COUPLING Ø 150 MM)	PCS	1

KIT RAPID FOR PROAIR PACK 5 ZONES WITH Ø 150 CONNECTIONS AND GRILLES IN ANTI-CONDENSATION ABS PLASTIC WITH ADJUSTABLE FLAPS

THE KIT CONSISTS OF:

- 5 ABS supply air outlets, installation opening 300 x 150 mm, external size 334 x 184 mm CODE PWD100014
- 5 insulated plenums with rear connection for outlet (300 x 150) CODE PWD402433
- 2 double-wall aluminium flexible pipes Ø 152 mm 10 m COD. 11152152
- 1 white aluminium intake grille with filter installation hole 1000 x 500 mm, external measurement 632 x 432 mm COD. WB11161525

KIT RAPID POUR COMPLÉTER PROAIR PACK 5 ZONES AVEC FIXATIONS Ø 150 ET GRILLES EN PLASTIQUE ABS ANTI-CONDENSATION À AILETTES RÉGLABLES

LE KIT SE COMPOSE DE:

- 5 bouches de soufflage en ABS, ouverture d'installation 300 x 150 mm, dimensions extérieures 334 x 184 mm CODE PWD100014
- 5 plénums isolés avec raccord arrière pour bouche (300 x 150) CODE PWD402433
- 2 tuyaux flexibles double paroi en aluminium Ø 152 mm 10 m code 11152152
- 1 grille de récupération en aluminium blanc avec filtre à trou d'installation 1000 x 500 mm, taille extérieure 632 x 432 mm code WB11161525

KIT RAPID ALS ERGÄNZUNG FÜR PROAIR PACK 5 ZONEN MIT ANSCHLÜSSEN Ø 150 UND LUFTGITTERN AUS ABS-KUNSTSTOFF, KONDENSATSCHUTZ MIT VERSTELLBAREN LAMELLEN

DER BAUSATZ BESTEHT AUS:

- 5 Zuluftauslässe aus ABS, Einbauloch 300 x 150 mm, Außenmaß 334 x 184 mm CODE PWD100014
- 5 isolierte Plenums mit Rückanschluss für Auslass (300 x 150) CODE PWD402433
- 2 Schläuche doppelwandig, aus Aluminium Ø 152 mm 10 m COD. 11152152
- 1 Ansauggitter aus Aluminium weiß lackiert mit Filter, Einbauöffnung 1000 x 500 Außenmaß 632 x 432 mm COD. WB11161525

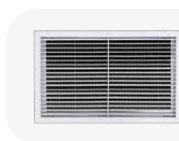
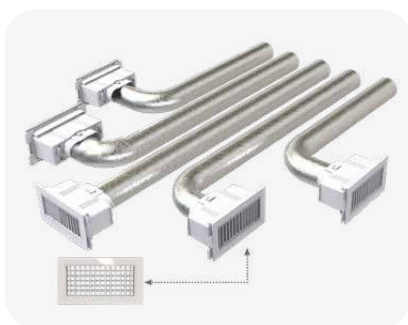

INTAKE GRILLE WITH FILTER
Installation hole 1000 x 500 mm

[Customisable on request](#)

CODE	DESCRIPTION	U.M.	Pieces per box
GAC500020	KIT RAPID 5 ZONES - (COUPLING Ø 150 MM)	PCS	1

KIT RAPID FOR PROAIR PACK 6 ZONES WITH Ø 150 CONNECTIONS AND GRILLES IN ANTI-CONDENSATION ABS PLASTIC WITH ADJUSTABLE FLAPS

THE KIT CONSISTS OF:

- 6 ABS supply air outlets, installation opening 300 x 150 mm, external size 334 x 184 mm CODE PWD100014
- 6 insulated plenums with rear connection for outlet (300 x 150) CODE PWD402433
- 2 double-wall aluminium flexible pipes Ø 152 mm 10 m COD. 11152152
- 1 white aluminium intake grille with filter installation hole 1000 x 500 mm, external measurement 632 x 432 mm COD. WB11161525

KIT RAPID POUR COMPLÉTER PROAIR PACK 6 ZONES AVEC FIXATIONS Ø 150 ET GRILLES EN PLASTIQUE ABS ANTI-CONDENSATION À AILETTES RÉGLABLES

LE KIT SE COMPOSE DE:

- 6 bouches de soufflage en ABS, ouverture d'installation 300 x 150 mm, dimensions extérieures 334 x 184 mm CODE PWD100014
- 6 plénums isolés avec raccord arrière pour bouche (300 x 150) CODE PWD402433
- 2 tuyaux flexibles double paroi en aluminium Ø 152 mm 10 m code 11152152
- 1 grille de récupération en aluminium blanc avec filtre à trou d'installation 1000 x 500 mm, taille extérieure 632 x 432 mm code WB11161525

KIT RAPID ALS ERGÄNZUNG FÜR PROAIR PACK 6 ZONEN MIT ANSCHLÜSSEN Ø 150 UND LUFTGITTERN AUS ABS-KUNSTSTOFF, KONDENSATSCHUTZ MIT VERSTELLBAREN LAMELLEN

DER BAUSATZ BESTEHT AUS:

- 6 Zuluftauslässe aus ABS, Einbauloch 300 x 150 mm, Außenmaß 334 x 184 mm CODE PWD100014
- 6 isolierte Plenums mit Rückanschluss für Auslass (300 x 150) CODE PWD402433
- 2 Schläuche doppelwandig, aus Aluminium Ø 152 mm 10 m COD. 11152152
- 1 Ansauggitter aus Aluminium weiß lackiert mit Filter, Einbauöffnung 1000 x 500 Außenmaß 632 x 432 mm COD. WB11161525

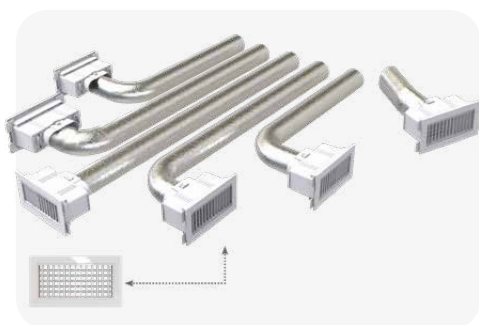

INTAKE GRILLE WITH FILTER
Installation hole 1000 x 500 mm

[Customisable on request](#)

CODE	DESCRIPTION	U.M.	Pieces per box
GAC500021	KIT RAPID 6 ZONES - (COUPLING Ø 150 MM)	PCS	1

WITH Ø200 CONNECTIONS, GRILLE IN ABS PLASTIC AND ADJUSTABLE DEFLECTORS

Ø200

KIT RAPID FOR PROAIR PACK 2 ZONES WITH Ø 200 CONNECTIONS AND GRILLES IN ANTI-CONDENSATION ABS PLASTIC WITH ADJUSTABLE FLAPS

THE KIT CONSISTS OF:

- No. 2 ABS plastic supply grilles, installation opening 300 x 150 mm, external size 334 x 184 mm, CODE PWD100014
- 2 insulated plenums with rear coupling for grille (300 x 150) COD. PWD402433
- 1 double-wall aluminium flexible hose Ø 203 mm 10 m COD. 11152204
- 1 white aluminium intake grille with filter installation hole 600 x 400 mm, external measurement 632 x 432 mm COD. WB11161525

KIT RAPID POUR COMPLÉTER PROAIR PACK 2 ZONES AVEC FIXATIONS Ø 200 ET GRILLES EN PLASTIQUE ABS ANTI-CONDENSATION À AILETTES RÉGLABLES

LE KIT SE COMPOSE DE:

- N° 2 bouches de soufflage en plastique ABS, ouverture d'installation 300 x 150 mm, dimension extérieure 334 x 184 mm, CODE PWD100014
- 2 plénums isolés avec fixation arrière pour grille (300 x 150) CODE PWD402433
- 1 tuyau flexible en aluminium double paroi Ø 203 mm de 10 m CODE 11152204
- 1 grille de récupération en aluminium blanc avec filtre à trou d'installation 600 x 400 mm, taille extérieure 632 x 432 mm code WB11161525

KIT RAPID ALS ERGÄNZUNG FÜR PROAIR PACK 2 ZONEN MIT ANSCHLÜSSEN Ø 200 UND LUFTGITTERN AUS ABS-KUNSTSTOFF, KONDENSATSCHUTZ MIT VERSTELLBAREN LAMELLEN

DER BAUSATZ BESTEHT AUS:

- 2 Ausblasgitter aus ABS-Kunststoff, Einbauöffnung 300 x 150 mm, Außenmaß 334 x 184 mm, CODE PWD100014
- 2 gedämmte Plenums mit hinterem Anschluss für Luftgitter (300 x 150) CODE PWD402433
- 1x 10 m Ø 203 mm Aluminium-Doppelwandschlauch CSB. 11152204
- 1 Ansauggitter aus Aluminium weiß lackiert mit Filter, Einbauöffnung 600 x 400 Außenmaß 632 x 432 mm COD. WB11161525

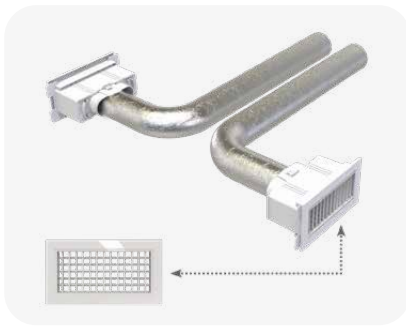

Customisable on request

CODE	DESCRIPTION	U.M.	Pieces per box
GAC500022	KIT RAPID 2 ZONES - (COUPLING Ø 200 MM)	PCS	1

KIT RAPID FOR PROAIR PACK 3 ZONES WITH Ø 200 CONNECTIONS AND GRILLES IN ANTI-CONDENSATION ABS PLASTIC WITH ADJUSTABLE FLAPS

THE KIT CONSISTS OF:

- No. 3 supply nozzles in ABS plastic, installation opening 300 x 150 mm, external size 334 x 184 mm, CODE PWD100014
- 3 insulated plenums with rear coupling for grille (300 x 150) COD. PWD402433
- 1 double-wall aluminium flexible hose Ø 203 mm 10 m COD. 11152204
- 1 white aluminium intake grille with filter installation hole 600 x 400 mm, external measurement 632 x 432 mm COD. WB11161525

KIT RAPID POUR COMPLÉTER PROAIR PACK 3 ZONES AVEC FIXATIONS Ø 200 ET GRILLES EN PLASTIQUE ABS ANTI-CONDENSATION À AILETTES RÉGLABLES

LE KIT SE COMPOSE DE:

- N°3 buses de soufflage en plastique ABS, ouverture d'installation 300 x 150 mm, dimensions extérieures 334 x 184 mm, CODE PWD100014
- 3 plénums isolés avec fixation arrière pour grille (300 x 150) CODE PWD402433
- 1 tuyau flexible en aluminium double paroi Ø 203 mm de 10 m CODE 11152204
- 1 grille de récupération en aluminium blanc avec filtre à trou d'installation 600 x 400 mm, taille extérieure 632 x 432 mm code WB11161525

KIT RAPID ALS ERGÄNZUNG FÜR PROAIR PACK 3 ZONEN MIT ANSCHLÜSSEN Ø 200 UND LUFTGITTERN AUS ABS-KUNSTSTOFF, KONDENSATSCHUTZ MIT VERSTELLBAREN LAMELLEN

DER BAUSATZ BESTEHT AUS:

- Nr. 3 Zuluftdüsen aus ABS-Kunststoff, Einbauöffnung 300 x 150 mm, Außenmaß 334 x 184 mm, CODE PWD100014
- 3 gedämmte Plenums mit hinterem Anschluss für Luftgitter (300 x 150) CODE PWD402433
- 1x 10 m Ø 203 mm Aluminium-Doppelwandschlauch CSB. 11152204
- 1 Ansauggitter aus Aluminium weiß lackiert mit Filter, Einbauöffnung 600 x 400 Außenmaß 632 x 432 mm COD. WB11161525

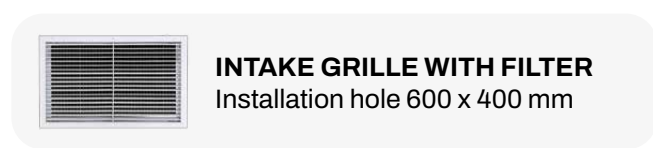
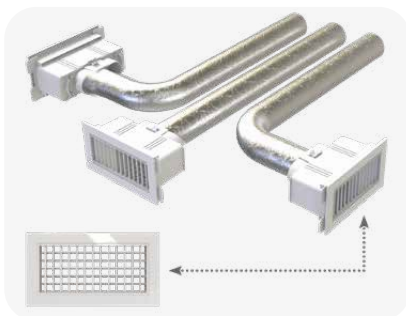

Customisable on request

CODE	DESCRIPTION	U.M.	Pieces per box
GAC500023	KIT RAPID 3 ZONES - (COUPLING Ø 200 MM)	PCS	1

**KIT RAPID FOR PROAIR
PACK 4 ZONES WITH Ø 200
CONNECTIONS AND GRILLES
IN ANTI-CONDENSATION ABS
PLASTIC WITH ADJUSTABLE
FLAPS**

THE KIT CONSISTS OF:

- No. 4 supply nozzles in ABS plastic, installation opening 300 x 150 mm, external size 334 x 184 mm, CODE PWD100014
- 4 insulated plenums with rear coupling for grille (300 x 150) COD. PWD402433
- 1 double-wall aluminium flexible hose Ø 203 mm 10 m COD. 11152204
- 1 white aluminium intake grille with filter installation hole 600 x 400 mm, external measurement 632 x 432 mm COD. WB11161525

**KIT RAPID POUR COMPLÉTER
PROAIR PACK 4 ZONES AVEC
FIXATIONS Ø 200 ET GRILLES
EN PLASTIQUE ABS ANTI-
CONDENSATION À AILETTES
RÉGLABLES**

LE KIT SE COMPOSE DE:

- N°4 buses de soufflage en plastique ABS, ouverture d'installation 300 x 150 mm, dimensions extérieures 334 x 184 mm, CODE PWD100014
- 4 plénums isolés avec fixation arrière pour grille (300 x 150) CODE PWD402433
- 1 tuyau flexible en aluminium double paroi Ø 203 mm de 10 m CODE 11152204
- 1 grille de récupération en aluminium blanc avec filtre à trou d'installation 600 x 400 mm, taille extérieure 632 x 432 mm code WB11161525

**KIT RAPID ALS ERGÄNZUNG
FÜR PROAIR PACK 4 ZONEN
MIT ANSCHLÜSSEN Ø 200
UND LUFTGITTERN AUS
ABS-KUNSTSTOFF, KONDEN-
SATSCHUTZ MIT VERSTELL-
BAREN LAMELLEN**

DER BAUSATZ BESTEHT AUS:

- Nr. 4 Zuluftdüsen aus ABS-Kunststoff, Einbauöffnung 300 x 150 mm, Außenmaß 334 x 184 mm, CODE PWD100014
- 4 gedämmte Plenums mit hinterem Anschluss für Luftgitter (300 x 150) CODE PWD402433
- 1x 10 m Ø 203 mm Aluminium-Doppelwandschlauch CSB. 11152204
- 1 Ansauggitter aus Aluminium weiß lackiert mit Filter, Einbauöffnung 600 x 400 Außenmaß 632 x 432 mm COD. WB11161525



[Customisable on request](#)

CODE	DESCRIPTION	U.M.	Pieces per box
GAC500024	KIT RAPID 4 ZONES - (COUPLING Ø 200 MM)	PCS	1

**KIT RAPID FOR PROAIR
PACK 5 ZONES WITH Ø 200
CONNECTIONS AND GRILLES
IN ANTI-CONDENSATION ABS
PLASTIC WITH ADJUSTABLE
FLAPS**

THE KIT CONSISTS OF:

- 5 ABS supply air outlets, installation opening 300 x 150 mm, external size 334 x 184 mm CODE PWD100014
- 5 insulated plenums with rear coupling for grille (300 x 150) COD. PWD402433
- 2 double-wall aluminium flexible pipes Ø 203 mm 10 m COD. 11152204
- 1 white aluminium intake grille with filter installation hole 1000 x 500 mm, external measurement 632 x 432 mm COD. WB11161525

**KIT RAPID POUR COMPLÉTER
PROAIR PACK 5 ZONES AVEC
FIXATIONS Ø 200 ET GRILLES
EN PLASTIQUE ABS ANTI-
CONDENSATION À AILETTES
RÉGLABLES**

LE KIT SE COMPOSE DE:

- 5 bouches de soufflage en ABS, ouverture d'installation 300 x 150 mm, dimensions extérieures 334 x 184 mm CODE PWD100014
- 5 plénums isolés avec fixation arrière pour grille (300 x 150) CODE PWD402433
- 2 tuyaux flexibles double paroi en aluminium Ø 203 mm 10 m code 11152204
- 1 grille de récupération en aluminium blanc avec filtre à trou d'installation 1000 x 500 mm, taille extérieure 632 x 432 mm code WB11161525

**KIT RAPID ALS ERGÄNZUNG
FÜR PROAIR PACK 5 ZONEN
MIT ANSCHLÜSSEN Ø 200
UND LUFTGITTERN AUS
ABS-KUNSTSTOFF, KONDEN-
SATSCHUTZ MIT VERSTELL-
BAREN LAMELLEN**

DER BAUSATZ BESTEHT AUS:

- 5 Zuluftauslässe aus ABS, Einbauloch 300 x 150 mm, Außenmaß 334 x 184 mm CODE PWD100014
- 5 gedämmte Plenums mit hinterem Anschluss für Luftgitter (300 x 150) CODE PWD402433
- 2 Schläuche doppelwandig, aus Aluminium Ø 203 mm 10 m COD. 11152204
- 1 Ansauggitter aus Aluminium weiß lackiert mit Filter, Einbauöffnung 1000 x 500 Außenmaß 632 x 432 mm COD. WB11161525

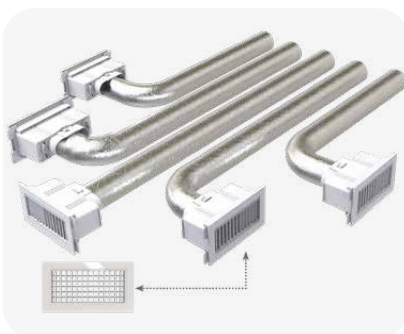

[Customisable on request](#)

CODE	DESCRIPTION	U.M.	Pieces per box
GAC500025	KIT RAPID 5 ZONES - (COUPLING Ø 200 MM)	PCS	1

 **KIT RAPID FOR PROAIR
PACK 6 ZONES WITH Ø 200
CONNECTIONS AND GRILLES
IN ANTI-CONDENSATION ABS
PLASTIC WITH ADJUSTABLE
FLAPS**

THE KIT CONSISTS OF:

- 6 ABS supply air outlets, installation opening 300 x 150 mm, external size 334 x 184 mm CODE PWD100014
- 6 insulated plenums with rear coupling for grille (300 x 150) COD. PWD402433
- 2 double-wall aluminium flexible pipes Ø 203 mm 10 m COD. 11152204
- 1 white aluminium intake grille with filter installation hole 1000 x 500 mm, external measurement 632 x 432 mm COD. WB11161525

 **KIT RAPID POUR COMPLÉTER
PROAIR PACK 6 ZONES AVEC
FIXATIONS Ø 200 ET GRILLES
EN PLASTIQUE ABS ANTI-
CONDENSATION À AILETTES
RÉGLABLES**

LE KIT SE COMPOSE DE:

- 6 bouches de soufflage en ABS, ouverture d'installation 300 x 150 mm, dimensions extérieures 334 x 184 mm CODE PWD100014
- 6 plénums isolés avec fixation arrière pour grille (300 x 150) CODE PWD402433
- 2 tuyaux flexibles double paroi en aluminium Ø 203 mm 10 m code 11152204
- 1 grille de récupération en aluminium blanc avec filtre à trou d'installation 1000 x 500 mm, taille extérieure 632 x 432 mm code WB11161525

 **KIT RAPID ALS ERGÄNZUNG
FÜR PROAIR PACK 6 ZONEN
MIT ANSCHLÜSSEN Ø 200
UND LUFTGITTERN AUS
ABS-KUNSTSTOFF, KONDEN-
SATSCHUTZ MIT VERSTELL-
BAREN LAMELLEN**

DER BAUSATZ BESTEHT AUS:

- 6 Zuluftauslässe aus ABS, Einbauloch 300 x 150 mm, Außenmaß 334 x 184 mm CODE PWD100014
- 6 gedämmte Plenums mit hinterem Anschluss für Luftgitter (300 x 150) CODE PWD402433
- 2 Schläuche doppelwandig, aus Aluminium Ø 203 mm 10 m COD. 11152204
- 1 Ansauggitter aus Aluminium weiß lackiert mit Filter, Einbauöffnung 1000 x 500 Außenmaß 632 x 432 mm COD. WB11161525

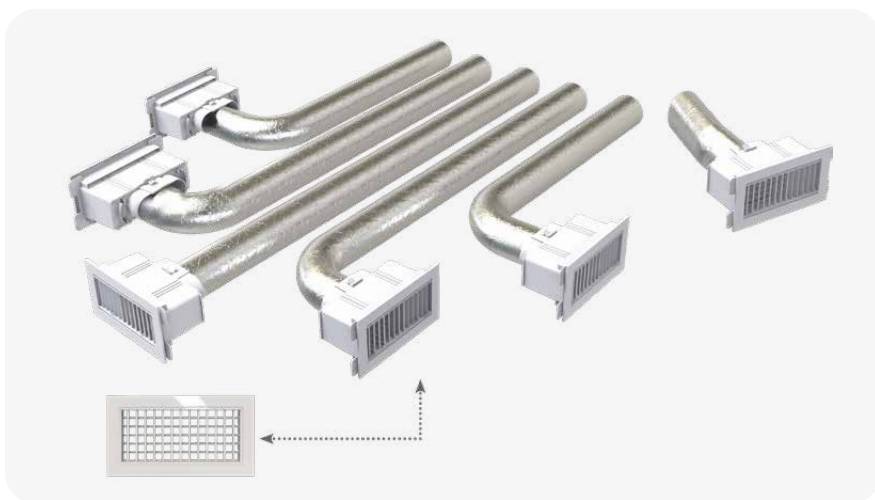

Customisable on request



INTAKE GRILLE WITH FILTER
Installation hole 1000 x 500 mm



CODE	DESCRIPTION	U.M.	Pieces per box
GAC500026	KIT RAPID 6 ZONES - (COUPLING Ø 200 MM)	PCS	1

WITH Ø125 CONNECTIONS, PAINTED ALUMINIUM GRILLES AND ADJUSTABLE DEFLECTORS

Ø125

UK KIT RAPID FOR PROAIR PACK 2 ZONES WITH Ø 125 CONNECTIONS AND ADJUSTABLE FLAP GRILLES

FR KIT RAPID POUR COMPLÉTER PROAIR PACK 2 ZONES AVEC FIXATIONS Ø 125 ET GRILLES À AILETTES RÉGLABLES

DE KIT RAPID ALS ERGÄNZUNG FÜR PROAIR PACK 2 ZONEN MIT ANSCHLÜSSEN Ø 125 UND EINSTELLBAREN LAMELLENLÜFTERN

THE KIT CONSISTS OF:

- 2 white painted aluminium delivery grilles, installation hole 300 x 100 mm, outer size 334 x 134 mm COD. WB11161505
- 2 insulated plenums with rear coupling for grille (300 x 100) COD. PWD100004
- 1 double-wall aluminium flexible hose Ø 127 mm 10 m COD. 11152127
- 1 white aluminium intake grille with filter installation hole 600 x 400 mm, external measurement 632 x 432 mm COD. WB11161525

LE KIT SE COMPOSE DE:

- 2 grilles de refoulement aluminium peint blanc, trou d'installation 300 x 100 mm, dimension extérieure 334 x 134 mm Réf. WB11161505
- 2 plénums isolés avec raccordement arrière pour buse (300 x 100) code PWD100004
- 1 tuyau flexible en aluminium double paroi Ø 127 mm de 10 m CODE 11152127
- 1 grille de récupération en aluminium blanc avec filtre à trou d'installation 600 x 400 mm, taille extérieure 632 x 432 mm code WB11161525

DER BAUSATZ BESTEHT AUS:

- 2 Zufuhrluftgitter aus weiß lackiertem Aluminium, Einbauöffnung 300 x 100 mm, Außenmaß 334 x 134 mm COD. WB11161505
- 2 gedämmte Plenums mit hinterem Anschluss für Luftgitter (300 x 100) COD. PWD100004
- 1x 10 m Ø 127 mm Aluminium-Doppelwandschlauch CSB. 11152127
- 1 Ansauggitter aus Aluminium weiß lackiert mit Filter, Einbauöffnung 600 x 400 Außenmaß 632 x 432 mm COD. WB11161525

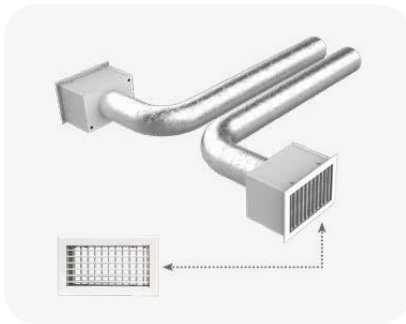

Customisable on request

CODE	DESCRIPTION	U.M.	Pieces per box
GAC500001	KIT RAPID 2 ZONES - (COUPLING Ø 125 mm)	PCS	1



UK KIT RAPID FOR PROAIR PACK 3 ZONES WITH Ø 125 CONNECTIONS AND ADJUSTABLE FLAP GRILLES

FR KIT RAPID POUR COMPLÉTER PROAIR PACK 3 ZONES AVEC FIXATIONS Ø 125 ET GRILLES À AILETTES RÉGLABLES

DE KIT RAPID ALS ERGÄNZUNG FÜR PROAIR PACK 3 ZONEN MIT ANSCHLÜSSEN Ø 125 UND EINSTELLBAREN LAMELLENLÜFTERN

THE KIT CONSISTS OF:

- 3 white painted aluminium delivery grilles, installation hole 300 x 100 mm, outer size 334 x 134 mm COD. WB11161505
- 3 insulated plenums with rear coupling for grille (300 x 100) COD. PWD100004
- 1 double-wall aluminium flexible hose Ø 127 mm 10 m COD. 11152127
- 1 white aluminium intake grille with filter installation hole 600 x 400 mm, external measurement 632 x 432 mm COD. WB11161525

LE KIT SE COMPOSE DE:

- 3 grilles d'alimentation aluminium peint blanc, trou d'installation 300 x 100 mm, dimension extérieure 334 x 134 mm CODE WB11161505
- 3 plénums isolés avec raccordement arrière pour buse (300 x 100) CODE PWD100004
- 1 tuyau flexible en aluminium double paroi Ø 127 mm de 10 m CODE 11152127
- 1 grille de récupération en aluminium blanc avec filtre à trou d'installation 600 x 400 mm, taille extérieure 632 x 432 mm code WB11161525

DER BAUSATZ BESTEHT AUS:

- 3 Zufuhrluftgitter weiß lackiertes Aluminium, Einbauöffnung 300 x 100 mm, Außenmaß 334 x 134 mm COD. WB11161505
- 3 gedämmte Plenums mit hinterem Anschluss für die Luftgitter (300 x 100) COD. PWD100004
- 1x 10 m Ø 127 mm Aluminium-Doppelwandschlauch CSB. 11152127
- 1 Ansauggitter aus Aluminium weiß lackiert mit Filter, Einbauöffnung 600 x 400 Außenmaß 632 x 432 mm COD. WB11161525

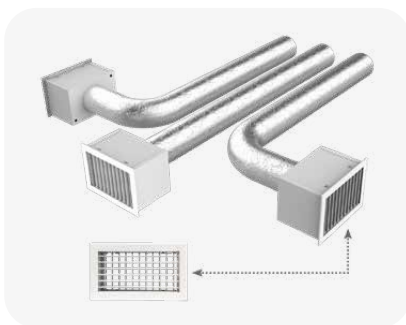

Customisable on request

CODE	DESCRIPTION	U.M.	Pieces per box
GAC500002	KIT RAPID 3 ZONES - (COUPLING Ø 125 mm)	PCS	1



UK **KIT RAPID FOR PROAIR PACK 4 ZONES WITH Ø 125 CONNECTIONS AND ADJUSTABLE FLAP GRILLES**

FR **KIT RAPID POUR COMPLÉTER PROAIR PACK 4 ZONES AVEC FIXATIONS Ø 125 ET GRILLES À AILETTES RÉGLABLES**

DE **KIT RAPID ALS ERGÄNZUNG FÜR PROAIR PACK 4 ZONEN MIT ANSCHLÜSSEN Ø 125 UND EINSTELLBAREN LABELNÜFTERN**

THE KIT CONSISTS OF:

- 4 white painted aluminium delivery grilles, installation hole 300 x 100 mm, outer size 334 x 134 mm COD. WB11161505
- 4 insulated plenums with rear coupling for grille (300 x 100) COD. PWD100004
- 1 double-wall aluminium flexible hose Ø 127 mm 10 m COD. 11152127
- 1 white aluminium intake grille with filter installation hole 600 x 400 mm, external measurement 632 x 432 mm COD. WB11161525

LE KIT SE COMPOSE DE:

- 4 grilles d'alimentation en aluminium peint blanc, trou d'installation 300 x 100 mm, dimension extérieure 334 x 134 mm CODE WB11161505
- 4 plénums isolés avec connexion arrière pour buse (300 x 100) CODE PWD100004
- 1 tuyau flexible en aluminium double paroi Ø 127 mm de 10 m CODE 11152127
- 1 grille de récupération en aluminium blanc avec filtre à trou d'installation 600 x 400 mm, taille extérieure 632 x 432 mm code WB11161525

DER BAUSATZ BESTEHT AUS:

- 4 Zufuhrluftgitter weiß lackiertes Aluminium, Einbauöffnung 300 x 100 mm, Außenmaß 334 x 134 mm COD. WB11161505
- 4 gedämmte Plenums mit hinterem Anschluss für die Luftgitter (300 x 100) COD. PWD100004
- 1x 10 m Ø 127 mm Aluminium-Doppelwandschlauch CSB. 11152127
- 1 Ansauggitter aus Aluminium weiß lackiert mit Filter, Einbauöffnung 600 x 400 Außenmaß 632 x 432 mm COD. WB11161525

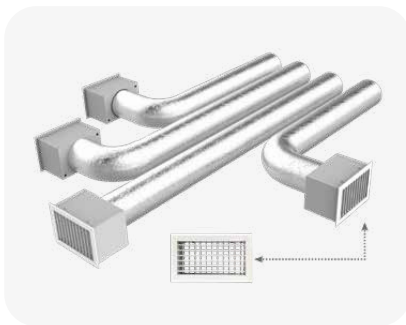

Customisable on request

CODE	DESCRIPTION	U.M.	Pieces per box
GAC500003	KIT RAPID 4 ZONES - (COUPLING Ø 125 mm)	PCS	1



WITH Ø150 CONNECTIONS, PAINTED ALUMINIUM GRILLES AND ADJUSTABLE DEFLECTORS

Ø150

UK **KIT RAPID FOR PROAIR PACK 2 ZONES WITH Ø 150 CONNECTIONS AND ADJUSTABLE FLAP GRILLES**

FR **KIT RAPID POUR COMPLÉTER PROAIR PACK 2 ZONES AVEC FIXATIONS Ø 150 ET GRILLES À AILETTES RÉGLABLES**

DE **KIT RAPID ALS ERGÄNZUNG FÜR PROAIR PACK 2 ZONEN MIT ANSCHLÜSSEN Ø 150 UND EINSTELLBAREN LABELNÜFTERN**

THE KIT CONSISTS OF:

- 2 white painted aluminum supply grilles, installation hole 300 x 150 mm, external dimensions 334 x 184 mm CODE WB11161512
- 2 insulated plenums with rear coupling for grille (300 x 150) COD. PWD100005
- 1 double-wall aluminium flexible hose Ø 152 mm 10 m COD. 11152152
- 1 white aluminium intake grille with filter installation hole 600 x 400 mm, external measurement 632 x 432 mm COD. WB11161525

LE KIT SE COMPOSE DE:

- N°2 grilles de soufflage en aluminium peint blanc, trou d'installation 300 x 150 mm, dimensions extérieures 334 x 184 mm CODE WB11161512
- 2 plénums isolés avec raccordement arrière pour buse (300 x 150) code PWD100005
- 1 tuyau flexible en aluminium double paroi Ø 152 mm de 10 m CODE 11152152
- 1 grille de récupération en aluminium blanc avec filtre à trou d'installation 600 x 400 mm, taille extérieure 632 x 432 mm code WB11161525

DER BAUSATZ BESTEHT AUS:

- Nr. 2 weiße, lackierte Aluminium-Luftgitter, Installationsloch 300 x 150 mm, Außenmaße 334 x 184 mm CODE WB11161512
- 2 gedämmte Plenums mit hinterem Anschluss für Luftgitter (300 x 150) COD. PWD100005
- 1x 10 m Ø 152 mm Aluminium-Doppelwandschlauch CSB. 11152152
- 1 Ansauggitter aus Aluminium weiß lackiert mit Filter, Einbauöffnung 600 x 400 Außenmaß 632 x 432 mm COD. WB11161525

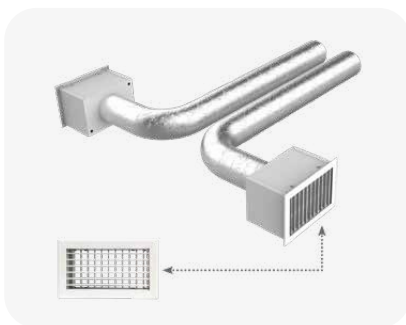

Customisable on request

CODE	DESCRIPTION	U.M.	Pieces per box
11171722	KIT RAPID 2 ZONE (COUPLING Ø 150 mm)	PCS	1



 **KIT RAPID FOR PROAIR
PACK 3 ZONES WITH Ø
150 CONNECTIONS AND
ADJUSTABLE FLAP GRILLES**

THE KIT CONSISTS OF:

- 3 white painted aluminum supply grilles, installation hole 300 x 150 mm, external dimensions 334 x 184mm CODE WB11161512
- 3 insulated plenums with rear coupling for grille (300 x 150) COD. PWD100005
- 1 double-wall aluminium flexible hose Ø 152 mm 10 m COD. 11152152
- 1 white aluminium intake grille with filter installation hole 600 x 400 mm, external measurement 632 x 432 mm COD. WB11161525

 **KIT RAPID POUR COMPLÉTER
PROAIR PACK 3 ZONES AVEC
FIXATIONS Ø 150 ET GRILLES
À AILETTES RÉGLABLES**

LE KIT SE COMPOSE DE:

- N°3 grilles de soufflage en aluminium peint blanc, trou d'installation 300 x 150 mm, dimensions extérieures 334 x 184 mm CODE WB11161512
- 3 plénums isolés avec raccordement arrière pour buse (300 x 150) CODE PWD100005
- 1 tuyau flexible en aluminium double paroi Ø 152 mm de 10 m CODE 11152152
- 1 grille de récupération en aluminium blanc avec filtre à trou d'installation 600 x 400 mm, taille extérieure 632 x 432 mm code WB11161525

 **KIT RAPID ALS ERGÄNZUNG
FÜR PROAIR PACK 3 ZONEN
MIT ANSCHLÜSSEN Ø 150
UND EINSTELLBAREN LAMEL-
LENLÜFTERN**

DER BAUSATZ BESTEHT AUS:

- Auslassdüsen Nr. 3 aus weiß lackiertem Aluminium, Einbauloch 300 x 150 mm, Außenmaße 334 x 184 mm, Art.-Nr. WB11161512
- 3 gedämmte Plenums mit hinterem Anschluss für die Luftgitter (300 x 150) COD. PWD100005
- 1x 10 m Ø 152 mm Aluminium-Doppelwandschlauch CSB. 11152152
- 1 Ansauggitter aus Aluminium weiß lackiert mit Filter, Einbauöffnung 600 x 400 Außenmaß 632 x 432 mm COD. WB11161525

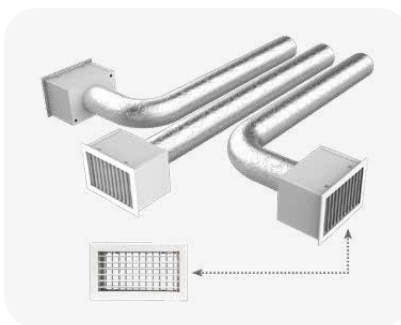

INTAKE GRILLE WITH FILTER
Installation hole 600 x 400 mm

Customisable on request

CODE	DESCRIPTION	U.M.	 Pieces per box
11171723	KIT RAPID 3 ZONE (COUPLING Ø 150 mm)	PCS	1



 **KIT RAPID FOR PROAIR
PACK 4 ZONES WITH Ø
150 CONNECTIONS AND
ADJUSTABLE FLAP GRILLES**

THE KIT CONSISTS OF:

- No. 4 supply vents in white-painted aluminum, installation opening 300 x 150 mm, external size 334 x 184 mm, CODE WB11161512
- 4 insulated plenums with rear coupling for grille (300 x 150) COD. PWD100005
- 1 double-wall aluminium flexible hose Ø 152 mm 10 m COD. 11152152
- 1 white aluminium intake grille with filter installation hole 600 x 400 mm, external measurement 632 x 432 mm COD. WB11161525

 **KIT RAPID POUR COMPLÉTER
PROAIR PACK 4 ZONES AVEC
FIXATIONS Ø 150 ET GRILLES
À AILETTES RÉGLABLES**

LE KIT SE COMPOSE DE:

- N°4 bouches de soufflage en aluminium peint en blanc, ouverture d'installation 300 x 150 mm, dimensions extérieures 334 x 184 mm, CODE WB11161512
- 4 plénums isolés avec connexion arrière pour buse (300 x 150) CODE PWD100005
- 1 tuyau flexible en aluminium double paroi Ø 152 mm de 10 m CODE 11152152
- 1 grille de récupération en aluminium blanc avec filtre à trou d'installation 600 x 400 mm, taille extérieure 632 x 432 mm code WB11161525

 **KIT RAPID ALS ERGÄNZUNG
FÜR PROAIR PACK 4 ZONEN
MIT ANSCHLÜSSEN Ø 150
UND EINSTELLBAREN LAMEL-
LENLÜFTERN**

DER BAUSATZ BESTEHT AUS:

- Nr. 4 Zuluftventile aus weiß lackiertem Aluminium, Einbauöffnung 300 x 150 mm, Außenmaß 334 x 184 mm, CODE WB11161512
- 4 gedämmte Plenums mit hinterem Anschluss für die Luftgitter (300 x 150) COD. PWD100005
- 1x 10 m Ø 152 mm Aluminium-Doppelwandschlauch CSB. 11152152
- 1 Ansauggitter aus Aluminium weiß lackiert mit Filter, Einbauöffnung 600 x 400 Außenmaß 632 x 432 mm COD. WB11161525

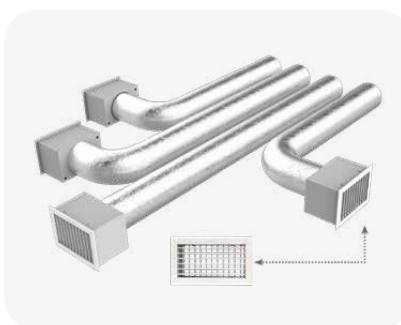

INTAKE GRILLE WITH FILTER
Installation hole 600 x 400 mm

Customisable on request

CODE	DESCRIPTION	U.M.	 Pieces per box
11171724	KIT RAPID 4 ZONE (COUPLING Ø 150 mm)	PCS	1



UK **KIT RAPID FOR PROAIR PACK 5 ZONES WITH Ø 150 CONNECTIONS AND ADJUSTABLE FLAP GRILLES**

THE KIT CONSISTS OF:

- 5 white painted aluminium delivery grilles, installation hole 300 x 100 mm, outer size 334 x 184 mm COD. WB11161512
- 5 isolated plenums with rear coupling for grille (300 x 150) cod. PWD100005
- 2 double-wall aluminium flexible pipes Ø 152 mm 10 m COD. 11152152
- 1 white aluminium intake grille with filter installation hole 1000 x 500 mm, external measurement 632 x 432 mm COD. WB11161525

FR **KIT RAPID POUR COMPLÉTER PROAIR PACK 5 ZONES AVEC FIXATIONS Ø 150 ET GRILLES À AILETTES RÉGLABLES**

LE KIT SE COMPOSE DE:

- 5 grilles d'alimentation en aluminium peint blanc, trou d'installation 300 x 100 mm, dimension extérieure 334 x 184 mm CODE WB11161512
- 5 plénum isolés avec raccordement arrière pour buse (300 x 150) CODE PWD100005
- 2 tuyaux flexibles double paroi en aluminium Ø 152 mm 10 m code 11152152
- 1 grille de récupération en aluminium blanc avec filtre à trou d'installation 1000 x 500 mm, taille extérieure 632 x 432 mm code WB11161525

DE **KIT RAPID ALS ERGÄNZUNG FÜR PROAIR PACK 5 ZONEN MIT ANSCHLÜSSEN Ø 150 UND EINSTELLBAREN LAMELLENLÜFTERN**

DER BAUSATZ BESTEHT AUS:

- 5 Zufuhrluftgitter weiß lackiertes Aluminium, Einbauöffnung 300 x 100 mm, Außenmaß 334 x 184 mm COD. WB11161512
- 5 gedämmte Plenums mit hinterem Anschluss für die Luftgitter (300 x 150) COD. PWD100005
- 2 Schläuche doppelwandig, aus Aluminium Ø 152 mm 10 m COD. 11152152
- 1 Ansauggitter aus Aluminium weiß lackiert mit Filter, Einbauöffnung 1000 x 500 Außenmaß 632 x 432 mm COD. WB11161525

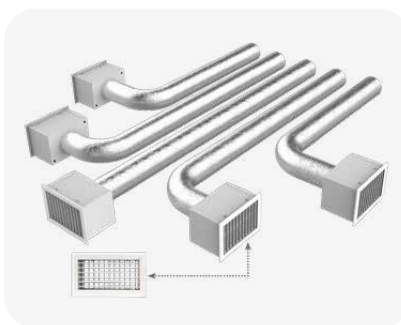

INTAKE GRILLE WITH FILTER
Installation hole 1000 x 500 mm

Customisable on request

CODE	DESCRIPTION	U.M.	Pieces per box
11171725	KIT RAPID 5 ZONE (COUPLING Ø 150 mm)	PCS	1



UK **KIT RAPID FOR PROAIR PACK 6 ZONES WITH Ø 150 CONNECTIONS AND ADJUSTABLE FLAP GRILLES**

THE KIT CONSISTS OF:

- 6 white painted aluminium supply grilles, installation hole 300 x 150 mm, outer size 334 x 184 mm COD. WB11161512
- 6 isolated plenums with rear coupling for grille (300 x 150) cod. PWD100005
- 2 double-wall aluminium flexible pipes Ø 152 mm 10 m COD. 11152152
- 1 white aluminium intake grille with filter installation hole 1000 x 500 mm, external measurement 632 x 432 mm COD. WB11161525

FR **KIT RAPID POUR COMPLÉTER PROAIR PACK 6 ZONES AVEC FIXATIONS Ø 150 ET GRILLES À AILETTES RÉGLABLES**

LE KIT SE COMPOSE DE:

- 6 grilles de refoulement en aluminium peint en blanc, trou d'installation 300 x 150 mm, dimension extérieure 334 x 184 mm CODE WB11161512
- 6 plénum isolés avec raccord arrière pour buse (300x 150) CODE PWD100005
- 2 tuyaux flexibles double paroi en aluminium Ø 152 mm 10 m code 11152152
- 1 grille de récupération en aluminium blanc avec filtre à trou d'installation 1000 x 500 mm, taille extérieure 632 x 432 mm code WB11161525

DE **KIT RAPID ALS ERGÄNZUNG FÜR PROAIR PACK 6 ZONEN MIT ANSCHLÜSSEN Ø 150 UND EINSTELLBAREN LAMELLENLÜFTERN**

DER BAUSATZ BESTEHT AUS:

- 6 Zuluftgitter, weiß lackiertes Aluminium, Einbauöffnung 300 x 150 mm, Außenmaß 334 x 184 mm COD. WB11161512
- 6 gedämmte Plenums mit hinterem Anschluss für die Luftgitter (300 x 150) COD. PWD100005
- 2 Schläuche doppelwandig, aus Aluminium Ø 152 mm 10 m COD. 11152152
- 1 Ansauggitter aus Aluminium weiß lackiert mit Filter, Einbauöffnung 1000 x 500 Außenmaß 632 x 432 mm COD. WB11161525

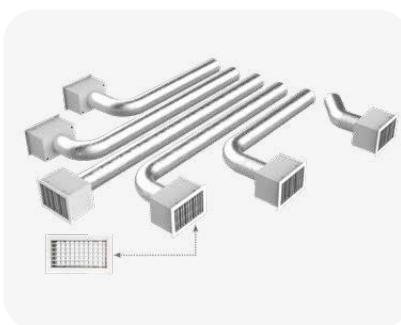

INTAKE GRILLE WITH FILTER
Installation hole 1000 x 500 mm

Customisable on request

CODE	DESCRIPTION	U.M.	Pieces per box
11171726	KIT RAPID 6 ZONE (COUPLING Ø 150 mm)	PCS	1



WITH Ø200 CONNECTIONS, PAINTED ALUMINIUM GRILLES AND ADJUSTABLE DEFLECTORS

Ø200

UK KIT RAPID FOR PROAIR PACK 2 ZONES WITH Ø 200 CONNECTIONS AND ADJUSTABLE FLAP GRILLES

FR KIT RAPID POUR COMPLÉTER PROAIR PACK 2 ZONES AVEC FIXATIONS Ø 200 ET GRILLES À AILETTES RÉGLABLES

DE KIT RAPID ALS ERGÄNZUNG FÜR PROAIR PACK 2 ZONEN MIT ANSCHLÜSSEN Ø 200 UND EINSTELLBAREN LAMELLENLÜFTERN

THE KIT CONSISTS OF:

- 2 white painted aluminium delivery grilles, installation hole 300 x 200 mm, outer size 334 x 234 mm COD. WB11161515
- 2 insulated plenums with rear coupling for grille (300 x 200) COD. PWD100007
- 1 double-wall aluminium flexible hose Ø 203 mm 10 m COD. 11152204
- 1 white aluminium intake grille with filter installation hole 600 x 400 mm, external measurement 632 x 432 mm COD. WB11161525

LE KIT SE COMPOSE DE:

- 2 grilles de refoulement aluminium peint blanc, trou d'installation 300 x 200 mm, dimension extérieure 334 x 234 mm Réf. WB11161515
- 2 plénums isolés avec raccordement arrière pour buse (300 x 200) code PWD100007
- 1 tuyau flexible en aluminium double paroi Ø 203 mm de 10 m CODE 11152204
- 1 grille de récupération en aluminium blanc avec filtre à trou d'installation 600 x 400 mm, taille extérieure 632 x 432 mm code WB11161525

DER BAUSATZ BESTEHT AUS:

- 2 Zufuhrluftgitter aus weiß lackiertem Aluminium, Einbauöffnung 300 x 200 mm, Außenmaß 334 x 234 mm COD. WB11161515
- 2 gedämmte Plenums mit hinterem Anschluss für Luftgitter (300 x 200) COD. PWD100007
- 1x 10 m Ø 203 mm Aluminium-Doppelwandschlauch CSB. 11152204
- 1 Ansauggitter aus Aluminium weiß lackiert mit Filter, Einbauöffnung 600 x 400 Außenmaß 632 x 432 mm COD. WB11161525

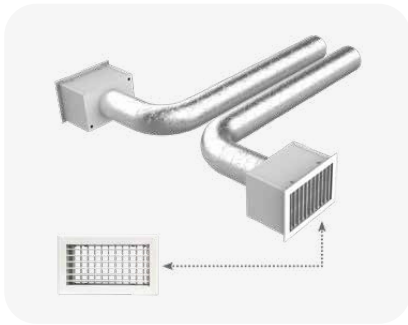

INTAKE GRILLE WITH FILTER
Installation hole 600 x 400 mm

Customisable on request

CODE	DESCRIPTION	U.M.	Pieces per box
11171732	KIT RAPID 2 ZONE (COUPLING Ø 200 mm)	PCS	1



UK KIT RAPID FOR PROAIR PACK 3 ZONES WITH Ø 200 CONNECTIONS AND ADJUSTABLE FLAP GRILLES

FR KIT RAPID POUR COMPLÉTER PROAIR PACK 3 ZONES AVEC FIXATIONS Ø 200 ET GRILLES À AILETTES RÉGLABLES

DE KIT RAPID ALS ERGÄNZUNG FÜR PROAIR PACK 3 ZONEN MIT ANSCHLÜSSEN Ø 200 UND EINSTELLBAREN LAMELLENLÜFTERN

THE KIT CONSISTS OF:

- 3 white painted aluminium delivery grilles, installation hole 300 x 200 mm, outer size 334 x 234 mm COD. WB11161515
- 3 insulated plenums with rear coupling for grille (300x 200) COD. PWD100007
- 1 double-wall aluminium flexible hose Ø 203 mm 10 m COD. 11152204
- 1 white aluminium intake grille with filter installation hole 600 x 400 mm, external measurement 632 x 432 mm COD. WB11161525

LE KIT SE COMPOSE DE:

- 3 grilles d'alimentation aluminium peint blanc, trou d'installation 300 x 200 mm, dimension extérieure 334 x 234 mm CODE WB11161515
- 3 plénums isolés avec raccordement arrière pour buse (300 x 200) CODE PWD100007
- 1 tuyau flexible en aluminium double paroi Ø 203 mm de 10 m CODE 11152204
- 1 grille de récupération en aluminium blanc avec filtre à trou d'installation 600 x 400 mm, taille extérieure 632 x 432 mm code WB11161525

DER BAUSATZ BESTEHT AUS:

- 3 Zufuhrluftgitter weiß lackiertes Aluminium, Einbauöffnung 300 x 200 mm, Außenmaß 334 x 234 mm COD. WB11161515
- 3 gedämmte Plenums mit hinterem Anschluss für die Luftgitter (300 x 200) COD. PWD100007
- 1x 10 m Ø 203 mm Aluminium-Doppelwandschlauch CSB. 11152204
- 1 Ansauggitter aus Aluminium weiß lackiert mit Filter, Einbauöffnung 600 x 400 Außenmaß 632 x 432 mm COD. WB11161525

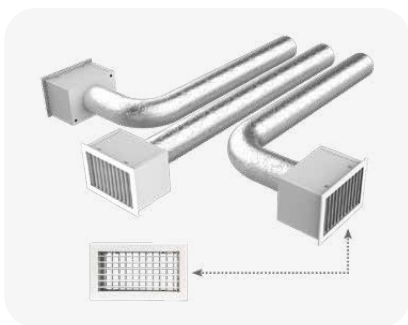

INTAKE GRILLE WITH FILTER
Installation hole 600 x 400 mm

Customisable on request

CODE	DESCRIPTION	U.M.	Pieces per box
11171733	KIT RAPID 3 ZONE (COUPLING Ø 200 mm)	PCS	1



**KIT RAPID FOR PROAIR
PACK 4 ZONES WITH Ø
200 CONNECTIONS AND
ADJUSTABLE FLAP GRILLES**

THE KIT CONSISTS OF:

- 4 white painted aluminium delivery grilles, installation hole 300 x 200 mm, outer size 334 x 234 mm COD. WB11161515
- 4 insulated plenums with rear coupling for grille (300 x 200) COD. PWD100007
- 1 double-wall aluminium flexible hose Ø 203 mm 10 m COD. 11152204
- 1 white aluminium intake grille with filter installation hole 600 x 400 mm, external measurement 632 x 432 mm COD. WB11161525

**KIT RAPID POUR COMPLÉTER
PROAIR PACK 4 ZONES AVEC
FIXATIONS Ø 200 ET GRILLES
À AILETTES RÉGLABLES**

LE KIT SE COMPOSE DE:

- 4 grilles d'alimentation en aluminium peint blanc, trou d'installation 300 x 200 mm, dimension extérieure 334 x 234 mm CODE WB11161515
- 4 plénums isolés avec connexion arrière pour buse (300 x 200) CODE PWD100007
- 1 tuyau flexible en aluminium double paroi Ø 203 mm de 10 m CODE 11152204
- 1 grille de récupération en aluminium blanc avec filtre à trou d'installation 600 x 400 mm, taille extérieure 632 x 432 mm code WB11161525

**KIT RAPID ALS ERGÄNZUNG
FÜR PROAIR PACK 4 ZONEN
MIT ANSCHLÜSSEN Ø 200
UND EINSTELLBAREN LABEL-
LENLÜFTERN**

DER BAUSATZ BESTEHT AUS:

- 4 Zufuhrluftgitter weiß lackiertes Aluminium, Einbauöffnung 300 x 200 mm, Außenmaß 334 x 234 mm COD. WB11161515
- 4 gedämmte Plenums mit hinterem Anschluss für die Luftgitter (300 x 200) COD. PWD100007
- 1x 10 m Ø 203 mm Aluminium-Doppelwandschlauch CSB. 11152204
- 1 Ansauggitter aus Aluminium weiß lackiert mit Filter, Einbauöffnung 600 x 400 Außenmaß 632 x 432 mm COD. WB11161525

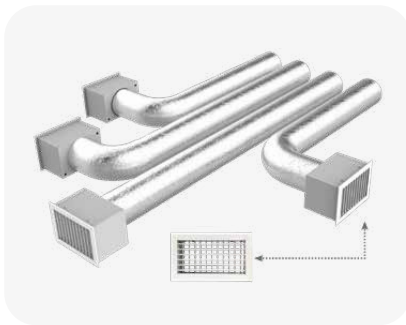

INTAKE GRILLE WITH FILTER
Installation hole 600 x 400 mm

Customisable on request

CODE	DESCRIPTION	U.M.	Pieces per box
11171734	KIT RAPID 4 ZONE (COUPLING Ø 200 mm)	PCS	1



**KIT RAPID FOR PROAIR
PACK 5 ZONES WITH Ø
200 CONNECTIONS AND
ADJUSTABLE FLAP GRILLES**

THE KIT CONSISTS OF:

- 5 white painted aluminium delivery grilles, installation hole 300 x 200 mm, outer size 334 x 234 mm COD. WB11161515
- 5 isolated plenums with rear coupling for grille (300 x 200) cod. PWD100007
- 2 double-wall aluminium flexible pipes Ø 203 mm 10 m COD. 11152204
- 1 white aluminium intake grille with filter installation hole 1000 x 500 mm, external measurement 632 x 432 mm COD. WB11161525

**KIT RAPID POUR COMPLÉTER
PROAIR PACK 5 ZONES AVEC
FIXATIONS Ø 200 ET GRILLES
À AILETTES RÉGLABLES**

LE KIT SE COMPOSE DE:

- 5 grilles d'alimentation en aluminium peint blanc, trou d'installation 300 x 200 mm, dimension extérieure 334 x 234 mm CODE WB11161515
- 5 plénums isolés avec raccordement arrière pour buse (300 x 200) CODE PWD100007
- 2 tuyaux flexibles double paroi en aluminium Ø 203 mm 10 m code 11152204
- 1 grille de récupération en aluminium blanc avec filtre à trou d'installation 1000 x 500 mm, taille extérieure 632 x 432 mm code WB11161525

**KIT RAPID ALS ERGÄNZUNG
FÜR PROAIR PACK 5 ZONEN
MIT ANSCHLÜSSEN Ø 200
UND EINSTELLBAREN LABEL-
LENLÜFTERN**

DER BAUSATZ BESTEHT AUS:

- 5 Zufuhrluftgitter weiß lackiertes Aluminium, Einbauöffnung 300 x 200 mm, Außenmaß 334 x 234 mm COD. WB11161515
- 5 gedämmte Plenums mit hinterem Anschluss für die Luftgitter (300 x 200) COD. PWD100007
- 2 Schläuche doppelwandig, aus Aluminium Ø 203 mm 10 m COD. 11152204
- 1 Ansauggitter aus Aluminium weiß lackiert mit Filter, Einbauöffnung 1000 x 500 Außenmaß 632 x 432 mm COD. WB11161525

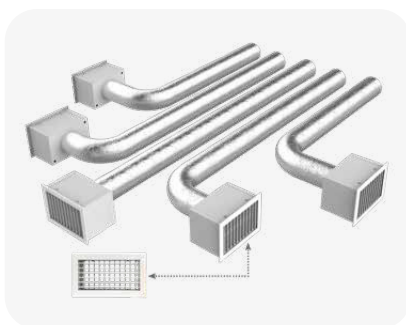

INTAKE GRILLE WITH FILTER
Installation hole 1000 x 500 mm

Customisable on request

CODE	DESCRIPTION	U.M.	Pieces per box
11171735	KIT RAPID 5 ZONE (COUPLING Ø 200 mm)	PCS	1



 **KIT RAPID FOR PROAIR
PACK 6 ZONES WITH Ø
200 CONNECTIONS AND
ADJUSTABLE FLAP GRILLES**

THE KIT CONSISTS OF:

- 6 white painted aluminium delivery grilles, installation hole 300 x 200 mm, outer size 334 x 234 mm COD. WB11161515
- 6 isolated plenums with rear coupling for grille (300 x 200) cod. PWD100007
- 2 double-wall aluminium flexible pipes Ø 203 mm 10 m COD. 11152204
- 1 white aluminium intake grille with filter installation hole 1000 x 500 mm, external measurement 632 x 432 mm COD. WB11161525

 **KIT RAPID POUR COMPLÉTER
PROAIR PACK 6 ZONES AVEC
FIXATIONS Ø 200 ET GRILLES
À AILETTES RÉGLABLES**

LE KIT SE COMPOSE DE:

- 6 grilles d'alimentation en aluminium peint blanc, trou d'installation 300 x 200 mm, dimension extérieure 334 x 234 mm CODE WB11161515
- 6 pléniums isolés avec raccord arrière pour buse (300 x 200) CODE PWD100007
- 2 tuyaux flexibles double paroi en aluminium Ø 203 mm 10 m code 11152204
- 1 grille de récupération en aluminium blanc avec filtre à trou d'installation 1000 x 500 mm, taille extérieure 632 x 432 mm code WB11161525

 **KIT RAPID ALS ERGÄNZUNG
FÜR PROAIR PACK 6 ZONEN
MIT ANSCHLÜSSEN Ø 200
UND EINSTELLBAREN LABEL-
LENLÜFTERN**

DER BAUSATZ BESTEHT AUS:

- 6 Zufuhrluftgitter weiß lackiertes Aluminium, Einbauöffnung 300 x 200 mm, Außenmaß 334 x 234 mm COD. WB11161515
- 6 gedämmte Plenums mit hinterem Anschluss für die Luftgitter (300 x 200) COD. PWD100007
- 2 Schläuche doppelwandig, aus Aluminium Ø 203 mm 10 m COD. 11152204
- 1 Ansauggitter aus Aluminium weiß lackiert mit Filter, Einbauöffnung 1000 x 500 Außenmaß 632 x 432 mm COD. WB11161525

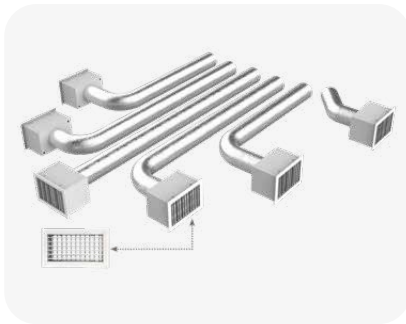

INTAKE GRILLE WITH FILTER
Installation hole 1000 x 500 mm

Customisable on request

CODE	DESCRIPTION	U.M.	Pieces per box
11171736	KIT RAPID 6 ZONE (COUPLING Ø 200 mm)	PCS	1



**WITH Ø150 CONNECTIONS, PAINTED ALUMINIUM GRILLES
AND ADJUSTABLE DEFLECTORS**

Ø150

 **KIT RAPID FOR PROAIR
PACK 2 ZONES WITH Ø 150
CONNECTIONS AND 15°
ADJUSTABLE DEFLECTOR**

THE KIT CONSISTS OF:

- No. 2 white-painted aluminum linear grilles with frame and fixed blades inclined at 15° – installation opening 300 x 150 mm, external size 335 x 185 mm, CODE PWC100106
- 2 insulated plenums with rear coupling for grille (300 x 150) COD. PWD100005
- 1 double-wall aluminium flexible hose Ø 152 mm 10 m COD. 11152152
- 1 white aluminium intake grille with filter installation hole 600 x 400 mm, external measurement 632 x 432 mm COD. WB11161525

 **KIT RAPID POUR COMPLÉTER
PROAIR PACK 2 ZONES AVEC
FIXATIONS Ø 150 ET GRILLES
À AILETTES INCLINÉES À 15°**

LE KIT SE COMPOSE DE:

- N° 2 bouches linéaires en aluminium peint en blanc avec cadre et ailettes fixes inclinées à 15° – ouverture d'installation 300 x 150 mm, dimension extérieure 335 x 185 mm, CODE PWC100106
- 2 pléniums isolés avec raccordement arrière pour buse (300 x 150) code PWD100005
- 1 tuyau flexible en aluminium double paroi Ø 152 mm de 10 m CODE 11152152
- 1 grille de récupération en aluminium blanc avec filtre à trou d'installation 600 x 400 mm, taille extérieure 632 x 432 mm code WB11161525

 **KIT RAPID ALS ERGÄNZUNG
FÜR PROAIR PACK 2 ZONEN
MIT ANSCHLÜSSEN Ø 150 UND
15°-GENEIGTEN SCHRÄG-
FLÜGELDÜSEN**

DER BAUSATZ BESTEHT AUS:

- 2 lineare Auslassgitter aus weiß lackiertem Aluminium mit Rahmen und festen, 15° geneigten Lamellen – Einbauöffnung 300 x 150 mm, Außenmaß 335 x 185 mm, CODE PWC100106
- 2 gedämmte Plenums mit hinterem Anschluss für Luftgitter (300 x 150) COD. PWD100005
- 1x 10 m Ø 152 mm Aluminium-Doppelwandschlauch CSB. 11152152
- 1 Ansauggitter aus Aluminium weiß lackiert mit Filter, Einbauöffnung 600 x 400 Außenmaß 632 x 432 mm COD. WB11161525

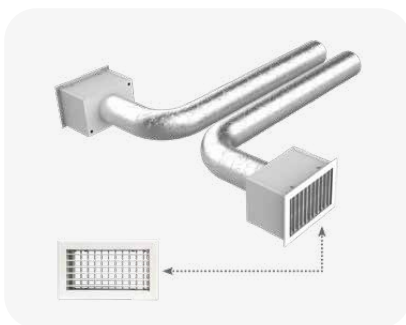

INTAKE GRILLE WITH FILTER
Installation hole 600 x 400 mm

Customisable on request

CODE	DESCRIPTION	U.M.	Pieces per box
GAC500004	KIT RAPID 2 ZONE (COUPLING Ø 150 mm)	PCS	1



**KIT RAPID FOR PROAIR
PACK 3 ZONES WITH Ø 150
CONNECTIONS AND 15°
INCLINED FLAP GRILLES**

THE KIT CONSISTS OF:

- No. 3 linear nozzles in white-painted aluminum with fixed 15° angled fin frame – installation opening 300 x 150 mm, external size 335 x 185 mm, CODE PWC100106
- 3 insulated plenums with rear coupling for grille (300 x 150) COD. PWD100005
- 1 double-wall aluminium flexible hose Ø 152 mm 10 m COD. 11152152
- 1 white aluminium intake grille with filter installation hole 600 x 400 mm, external measurement 632 x 432 mm COD. WB11161525

**KIT RAPID POUR COMPLÉTER
PROAIR PACK 3 ZONES AVEC
FIXATIONS Ø 150 ET GRILLES
À AILETTES INCLINÉES À 15°**

LE KIT SE COMPOSE DE:

- N°3 buses linéaires en aluminium peint en blanc avec cadre à ailettes fixes inclinées à 15° – ouverture d'installation 300 x 150 mm, dimensions extérieures 335 x 185 mm, CODE PWC100106
- 3 plénums isolés avec raccordement arrière pour buse (300 x 150) CODE PWD100005
- 1 tuyau flexible en aluminium double paroi Ø 152 mm de 10 m CODE 11152152
- 1 grille de récupération en aluminium blanc avec filtre à trou d'installation 600 x 400 mm, taille extérieure 632 x 432 mm code WB11161525

**KIT RAPID ALS ERGÄNZUNG
FÜR PROAIR PACK 3 ZONEN
MIT ANSCHLÜSSEN Ø 150 UND
15°-GENEIGTEN SCHRÄG-
FLÜGELDÜSEN**

DER BAUSATZ BESTEHT AUS:

- Nr. 3 lineare Düsen aus weiß lackiertem Aluminium mit feststehenden, 15° geneigten Lamellenrahmen – Einbauöffnung 300 x 150 mm, Außenmaß 335 x 185 mm, CODE PWC100106
- 3 gedämmte Plenums mit hinterem Anschluss für die Luftgitter (300 x 150) COD. PWD100005
- 1x 10 m Ø 152 mm Aluminium-Doppelwandschlauch CSB. 11152152
- 1 Ansauggitter aus Aluminium weiß lackiert mit Filter, Einbauöffnung 600 x 400 Außenmaß 632 x 432 mm COD. WB11161525

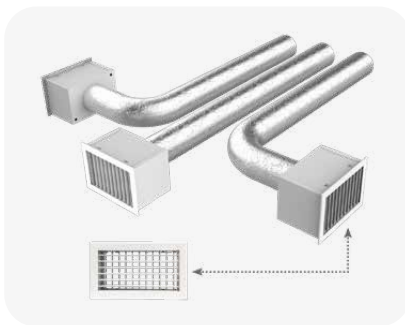

Customisable on request

CODE	DESCRIPTION	U.M.	Pieces per box
GAC500005	KIT RAPID 3 ZONE (COUPLING Ø 150 mm)	PCS	1



**KIT RAPID FOR PROAIR
PACK 4 ZONES WITH Ø 150
CONNECTIONS AND 15°
INCLINED FLAP GRILLES**

THE KIT CONSISTS OF:

- No. 4 linear nozzles in white-painted aluminum with fixed 15° angled fin frame – installation opening 300 x 150 mm, external size 335 x 185 mm, CODE PWC100106
- 4 insulated plenums with rear coupling for grille (300 x 150) COD. PWD100005
- 1 double-wall aluminium flexible hose Ø 152 mm 10 m COD. 11152152
- 1 white aluminium intake grille with filter installation hole 600 x 400 mm, external measurement 632 x 432 mm COD. WB11161525

**KIT RAPID POUR COMPLÉTER
PROAIR PACK 4 ZONES AVEC
FIXATIONS Ø 150 ET GRILLES
À AILETTES INCLINÉES À 15°**

LE KIT SE COMPOSE DE:

- N°4 buses linéaires en aluminium peint en blanc avec cadre à ailettes fixes inclinées à 15° – ouverture d'installation 300 x 150 mm, dimensions extérieures 335 x 185 mm, CODE PWC100106
- 4 plénums isolés avec connexion arrière pour buse (300 x 150) CODE PWD100005
- 1 tuyau flexible en aluminium double paroi Ø 152 mm de 10 m CODE 11152152
- 1 grille de récupération en aluminium blanc avec filtre à trou d'installation 600 x 400 mm, taille extérieure 632 x 432 mm code WB11161525

**KIT RAPID ALS ERGÄNZUNG
FÜR PROAIR PACK 4 ZONEN
MIT ANSCHLÜSSEN Ø 150 UND
15°-GENEIGTEN SCHRÄG-
FLÜGELDÜSEN**

DER BAUSATZ BESTEHT AUS:

- Nr. 4 lineare Düsen aus weiß lackiertem Aluminium mit feststehenden, 15° geneigten Lamellenrahmen – Einbauöffnung 300 x 150 mm, Außenmaß 335 x 185 mm, CODE PWC100106
- 4 gedämmte Plenums mit hinterem Anschluss für die Luftgitter (300 x 150) COD. PWD100005
- 1x 10 m Ø 152 mm Aluminium-Doppelwandschlauch CSB. 11152152
- 1 Ansauggitter aus Aluminium weiß lackiert mit Filter, Einbauöffnung 600 x 400 Außenmaß 632 x 432 mm COD. WB11161525

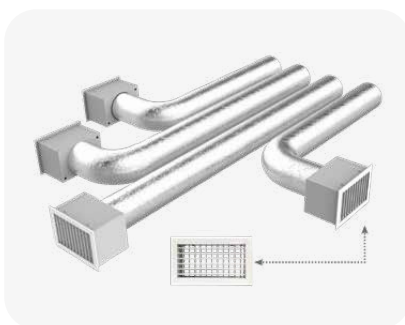

Customisable on request

CODE	DESCRIPTION	U.M.	Pieces per box
GAC500006	KIT RAPID 4 ZONE (COUPLING Ø 150 mm)	PCS	1



**KIT RAPID FOR PROAIR
PACK 5 ZONES WITH Ø 150
CONNECTIONS AND 15°
INCLINED FLAP GRILLES**

THE KIT CONSISTS OF:

- 5 linear white-painted aluminum outlets with frame and fixed blades inclined at 15° – installation opening 300 x 150 mm, external size 335 x 185 mm CODE PWC100106
- 5 isolated plenums with rear coupling for grille (300 x 150) cod. PWD100005
- 2 double-wall aluminium flexible pipes Ø 152 mm 10 m COD. 11152152
- 1 white aluminium intake grille with filter installation hole 1000 x 500 mm, external measurement 632 x 432 mm COD. WB11161525

**KIT RAPID POUR COMPLÉTER
PROAIR PACK 5 ZONES AVEC
FIXATIONS Ø 150 ET GRILLES
À AILETTES INCLINÉES À 15°**

LE KIT SE COMPOSE DE:

- 5 bouches linéaires en aluminium peint en blanc avec cadre et ailettes fixes inclinées à 15° – ouverture d'installation 300 x 150 mm, dimensions extérieures 335 x 185 mm CODE PWC100106
- 5 plénums isolés avec raccordement arrière pour buse (300 x 150) CODE PWD100005
- 2 tuyaux flexibles double paroi en aluminium Ø 152 mm 10 m code 11152152
- 1 grille de récupération en aluminium blanc avec filtre à trou d'installation 1000 x 500 mm, taille extérieure 632 x 432 mm code WB11161525

**KIT RAPID ALS ERGÄNZUNG
FÜR PROAIR PACK 5 ZONEN
MIT ANSCHLÜSSEN Ø 150 UND
15°-GENEIGTEN SCHRÄG-
FLÜGELDÜSEN**

DER BAUSATZ BESTEHT AUS:

- 5 lineare Lüftungsauslässe aus weiß lackiertem Aluminium mit Rahmen und festen Lamellen, 15° geneigt – Einbauloch 300 x 150 mm, Außenmaß 335 x 185 mm CODE PWC100106
- 5 gedämmte Plenums mit hinterem Anschluss für die Luftgitter (300 x 150) COD. PWD100005
- 2 Schläuche doppelwandig, aus Aluminium Ø 152 mm 10 m COD. 11152152
- 1 Ansauggitter aus Aluminium weiß lackiert mit Filter, Einbauöffnung 1000 x 500 Außenmaß 632 x 432 mm COD. WB11161525

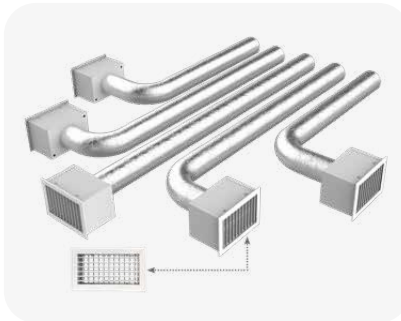

INTAKE GRILLE WITH FILTER
Installation hole 1000 x 500 mm

Customisable on request

CODE	DESCRIPTION	U.M.	Pieces per box
GAC500007	KIT RAPID 5 ZONE (COUPLING Ø 150 mm)	PCS	1



**KIT RAPID FOR PROAIR
PACK 6 ZONES WITH Ø 150
CONNECTIONS AND 15°
INCLINED FLAP GRILLES**

THE KIT CONSISTS OF:

- 6 linear white-painted aluminum outlets with frame and fixed blades inclined at 15° – installation opening 300 x 150 mm, external size 335 x 185 mm CODE PWC100106
- 6 isolated plenums with rear coupling for grille (300 x 150) cod. PWD100005
- 2 double-wall aluminium flexible pipes Ø 152 mm 10 m COD. 11152152
- 1 white aluminium intake grille with filter installation hole 1000 x 500 mm, external measurement 632 x 432 mm COD. WB11161525

**KIT RAPID POUR COMPLÉTER
PROAIR PACK 6 ZONES AVEC
FIXATIONS Ø 150 ET GRILLES
À AILETTES INCLINÉES À 15°**

LE KIT SE COMPOSE DE:

- 6 bouches linéaires en aluminium peint en blanc avec cadre et ailettes fixes inclinées à 15° – ouverture d'installation 300 x 150 mm, dimensions extérieures 335 x 185 mm CODE PWC100106
- 6 plénums isolés avec raccord arrière pour buse (300 x 150) CODE PWD100005
- 2 tuyaux flexibles double paroi en aluminium Ø 152 mm 10 m code 11152152
- 1 grille de récupération en aluminium blanc avec filtre à trou d'installation 1000 x 500 mm, taille extérieure 632 x 432 mm code WB11161525

**KIT RAPID ALS ERGÄNZUNG
FÜR PROAIR PACK 6 ZONEN
MIT ANSCHLÜSSEN Ø 150 UND
15°-GENEIGTEN SCHRÄG-
FLÜGELDÜSEN**

DER BAUSATZ BESTEHT AUS:

- 6 lineare Lüftungsauslässe aus weiß lackiertem Aluminium mit Rahmen und festen Lamellen, 15° geneigt – Einbauloch 300 x 150 mm, Außenmaß 335 x 185 mm CODE PWC100106
- 6 gedämmte Plenums mit hinterem Anschluss für die Luftgitter (300 x 150) COD. PWD100005
- 2 Schläuche doppelwandig, aus Aluminium Ø 152 mm 10 m COD. 11152152
- 1 Ansauggitter aus Aluminium weiß lackiert mit Filter, Einbauöffnung 1000 x 500 Außenmaß 632 x 432 mm COD. WB11161525

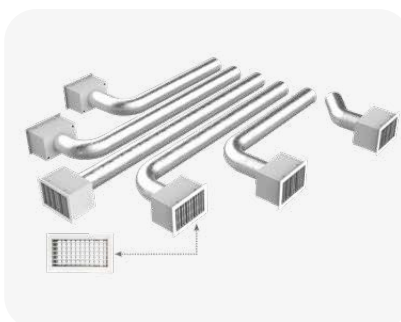

INTAKE GRILLE WITH FILTER
Installation hole 1000 x 500 mm

Customisable on request

CODE	DESCRIPTION	U.M.	Pieces per box
GAC500008	KIT RAPID 6 ZONE (COUPLING Ø 150 mm)	PCS	1



WITH Ø150 CONNECTIONS AND LINEAR DIFFUSERS L 1000 MM, 2 SLOTS

Ø150

NEW

UK **KIT RAPID FOR PROAIR PACK 2 ZONES WITH Ø 150 CONNECTIONS AND LINEAR DIFFUSERS L=1000 MM 2 SLOTS**

THE KIT CONSISTS OF:

- No. 2 linear aluminium diffusers with damper, 2 white slots, length 1000 mm, CODE PWD301634
- 2 insulated universal plenums for linear diffuser 2 slots L 1000 mm COD. PWD4002591
- 1 double-wall aluminium flexible hose Ø 152 mm 10 m COD. 11152152
- 1 white aluminium intake grille with filter installation hole 600 x 400 mm, external measurement 632 x 432 mm COD. WB11161525
- 4 hose clamps

FR **KIT RAPID POUR COMPLÉTER PROAIR PACK 2 ZONES AVEC FIXATIONS Ø 150 ET DIFFUSEURS LINÉAIRES EN PVC L=1000 MM 2 FENTES**

LE KIT SE COMPOSE DE:

- No. 2 linear aluminium diffusers with damper, 2 white slots, length 1000 mm, CODE PWD301634
- 2 plénums universels isolés pour diffuseur linéaire 2 fentes L 1000 mm CODE PWD4002591
- 1 tuyau flexible en aluminium double paroi Ø 152 mm de 10 m CODE 11152152
- 1 grille de récupération en aluminium blanc avec filtre à trou d'installation 600 x 400 mm, taille extérieure 632 x 432 mm code WB11161525
- 4 Colliers de serrage

DE **KIT RAPID ALS ERGÄNZUNG FÜR PROAIR PACK 2 ZONEN MIT ANSCHLÜSSEN Ø 150 UND LINEAREN DIFFUSOREN AUS PVC L= 1000 MM – 2 SCHLITZE**

DER BAUSATZ BESTEHT AUS:

- Nr. 2 lineare Aluminium-Luftauslässe mit Drosselklappe, 2 weiße Schlitze, Länge 1000 mm, CODE PWD301634
- 2 gedämmte Plenums für linearen Luftdurchlass 2 Schlitze L 1000 mm COD. PWD4002591
- 1x 10 m Ø 152 mm Aluminium-Doppelwandschlauch CSB. 11152152
- 1 Ansauggitter aus Aluminium weiß lackiert mit Filter, Einbauöffnung 600 x 400 Außenmaß 632 x 432 mm COD. WB11161525
- 4 Rohrschellen

NEW

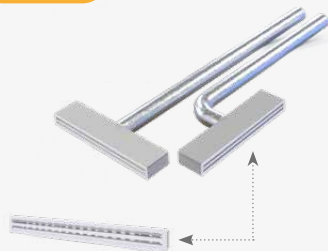

INTAKE GRILLE WITH FILTER
Installation hole 600 x 400 mm

Linear diffuser in PVC on request

Customisable on request

CODICE	DESCRIZIONE	U.M.	Multiplo d'ordine U.M.
GAD500001	RAPID KIT TO COMPLETE THE PROAIR 2 ZONES WITH Ø150 CONNECTIONS AND 1000 MM 2-SLOTS ALUMINIUM LINEAR DIFFUSERS	KIT	1



UK **KIT RAPID FOR PROAIR PACK 3 ZONES WITH Ø 150 CONNECTIONS AND LINEAR DIFFUSERS L=1000 MM 2 SLOTS**

THE KIT CONSISTS OF:

- N° 3 linear aluminum diffusers with damper, 2 slots, white color, L 1000 mm, CODE PWD301634
- 3 insulated universal plenums for linear diffuser 2 slots L 1000 mm COD. PWD4002591
- 1 double-wall aluminium flexible hose Ø 152 mm 10 m COD. 11152152
- 1 white aluminium intake grille with filter installation hole 600 x 400 mm, external measurement 632 x 432 mm COD. WB11161525
- 6 hose clamps

FR **KIT RAPID POUR COMPLÉTER PROAIR PACK 3 ZONES AVEC FIXATIONS Ø 150 ET DIFFUSEURS LINÉAIRES L=1000 MM 2 FENTES**

LE KIT SE COMPOSE DE:

- N°3 diffuseurs linéaires en aluminium avec registre, 2 fentes, couleur blanche, L 1000 mm, CODE PWD301634
- 3 plénums universels isolés pour diffuseur linéaire 2 fentes L 1000 mm CODE PWD4002591
- 1 tuyau flexible en aluminium double paroi Ø 152 mm de 10 m CODE 11152152
- 1 grille de récupération en aluminium blanc avec filtre à trou d'installation 600 x 400 mm, taille extérieure 632 x 432 mm code WB11161525
- 6 colliers de serrage

DE **KIT RAPID ALS ERGÄNZUNG FÜR PROAIR PACK 3 ZONEN MIT ANSCHLÜSSEN Ø 150 UND LINEAREN DIFFUSOREN 1000 MM 2 SCHLITZEN**

DER BAUSATZ BESTEHT AUS:

- Nr. 3 lineare Aluminium-Luftauslässe mit Klappe, 2 Schlitze, weiße Farbe, L 1000 mm, CODE PWD301634
- 3 isolierte Universalkammern für lineare Luftdurchlässe 2 Schlitze L 1000 mm COD. PWD4002591
- 1x 10 m Ø 152 mm Aluminium-Doppelwandschlauch CSB. 11152152
- 1 Ansauggitter aus Aluminium weiß lackiert mit Filter, Einbauöffnung 600 x 400 Außenmaß 632 x 432 mm COD. WB11161525
- 6 Rohrschellen

NEW

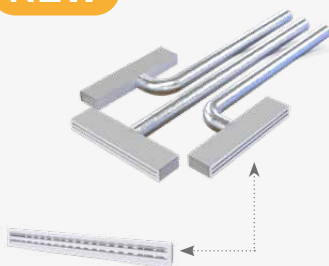

INTAKE GRILLE WITH FILTER
Installation hole 600 x 400 mm

Linear diffuser in PVC on request

Customisable on request

CODICE	DESCRIZIONE	U.M.	Multiplo d'ordine U.M.
GAD500002	RAPID KIT TO COMPLETE THE PROAIR 3 ZONES WITH Ø150 CONNECTIONS AND 1000 MM 2-SLOTS ALUMINIUM LINEAR DIFFUSERS	KIT	1



Galaxy

**KIT RAPID FOR PROAIR
PACK 4 ZONES WITH Ø 150
CONNECTIONS AND LINEAR
DIFFUSERS L=1000 MM 2
SLOTS**

THE KIT CONSISTS OF:

- No. 4 linear aluminum diffusers with damper, 2 white slots, L 1000 mm, CODE PWD301634
- 4 insulated universal plenums for linear diffuser 2 slots L 1000 mm COD. PWD402591
- 1 double-wall aluminium flexible hose Ø 152 mm 10 m COD. 11152152
- 1 white aluminium intake grille with filter installation hole 600 x 400 mm, external measurement 632 x 432 mm COD. WB11161525
- 8 hose clamps

**KIT RAPID POUR COMPLÉTER
PROAIR PACK 4 ZONES
AVEC FIXATIONS Ø 150 ET
DIFFUSEURS LINÉAIRES
L=1000 MM 2 FENTES**

LE KIT SE COMPOSE DE:

- N°4 diffuseurs linéaires en aluminium avec registre, 2 fentes blanches, L 1000 mm, CODE PWD301634
- 4 plénums universels isolés pour diffuseur linéaire 2 fentes L 1000 mm CODE PWD402591
- 1 tuyau flexible en aluminium double paroi Ø 152 mm de 10 m CODE 11152152
- 1 grille de récupération en aluminium blanc avec filtre à trou d'installation 600 x 400 mm, taille extérieure 632 x 432 mm code WB11161525
- 8 Colliers de serrage

**KIT RAPID ALS ERGÄNZUNG
FÜR PROAIR PACK 4 ZONEN
MIT ANSCHLÜSSEN Ø 150 UND
LINEAREN DIFFUSOREN 1000
MM 2 SCHLITZEN**

DER BAUSATZ BESTEHT AUS:

- Nr. 4 lineare Aluminiumdiffusoren mit Klappe, 2 weiße Schlitze, L 1000 mm, CODE PWD301634
- 4 gedämmte Universal-Plenums für lineare Luftdurchlässe 2 Schlitze L 1000 mm COD. PWD402591
- 1x 10 m Ø 152 mm Aluminium-Doppelwandschlauch CSB. 11152152
- 1 Ansauggitter aus Aluminium weiß lackiert mit Filter, Einbauöffnung 600 x 400 Außenmaß 632 x 432 mm COD. WB11161525
- 8 Rohrschellen

NEW

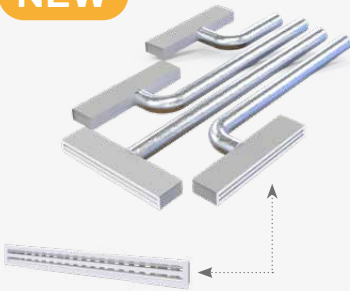

INTAKE GRILLE WITH FILTER
Installation hole 600 x 400 mm

Linear diffuser
in PVC on request

Customisable on request

CODICE	DESCRIZIONE	U.M.	Multiplo d'ordine U.M.
GAD500003	RAPID KIT TO COMPLETE THE PROAIR 4 ZONES WITH Ø150 CONNECTIONS AND 1000 MM 2-SLOTS ALUMINIUM LINEAR DIFFUSERS	KIT	1



**KIT RAPID FOR PROAIR
PACK 5 ZONES WITH Ø 150
CONNECTIONS AND LINEAR
DIFFUSERS L=1000 MM 2
SLOTS**

THE KIT CONSISTS OF:

- No. 5 linear aluminum diffusers with damper, 2 white slots, L 1000 mm, CODE PWD301634
- 5 insulated universal plenums for linear diffuser 2 slots L 1000 mm COD. PWD402591
- 2 double-wall aluminium flexible pipes Ø 152 mm 10 m COD. 11152152
- 1 white aluminium intake grille with filter installation hole 1000 x 500 mm, external measurement 632 x 432 mm COD. WB11161525
- 10 hose clamps

**KIT RAPID POUR COMPLÉTER
PROAIR PACK 5 ZONES
AVEC FIXATIONS Ø 150 ET
DIFFUSEURS LINÉAIRES
L=1000 MM 2 FENTES**

LE KIT SE COMPOSE DE:

- N°5 diffuseurs linéaires en aluminium avec registre, 2 fentes blanches, L 1000 mm, CODE PWD301634
- 5 plénums universels isolés pour diffuseur linéaire 2 fentes L 1000 mm CODE PWD402591
- 2 tuyaux flexibles double paroi en aluminium Ø 152 mm 10 m code 11152152
- 1 grille de récupération en aluminium blanc avec filtre à trou d'installation 1000 x 500 mm, taille extérieure 632 x 432 mm code WB11161525
- 10 colliers de serrage

**KIT RAPID ALS ERGÄNZUNG
FÜR PROAIR PACK 5 ZONEN
MIT ANSCHLÜSSEN Ø 150 UND
LINEAREN DIFFUSOREN 1000
MM 2 SCHLITZEN**

DER BAUSATZ BESTEHT AUS:

- Nr. 5 lineare Aluminiumdiffusoren mit Klappe, 2 weiße Schlitze, L 1000 mm, CODE PWD301634
- 5 gedämmte Universal-Plenums für lineare Luftdurchlässe 2 Schlitze L 1000 mm COD. PWD402591
- 2 Schläuche doppelwandig, aus Aluminium Ø 152 mm 10 m COD. 11152152
- 1 Ansauggitter aus Aluminium weiß lackiert mit Filter, Einbauöffnung 1000 x 500 Außenmaß 632 x 432 mm COD. WB11161525
- 10 Rohrschellen

NEW

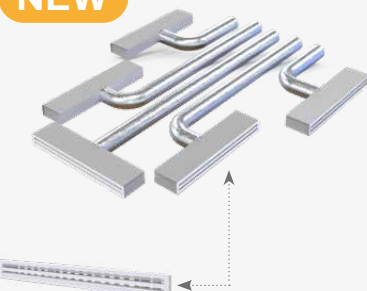

INTAKE GRILLE WITH FILTER
Installation hole 600 x 400 mm

Linear diffuser
in PVC on request

Customisable on request

CODICE	DESCRIZIONE	U.M.	Multiplo d'ordine U.M.
GAD500004	RAPID KIT TO COMPLETE THE PROAIR 5 ZONES WITH Ø150 CONNECTIONS AND 1000 MM 2-SLOTS ALUMINIUM LINEAR DIFFUSERS	KIT	1



UK **KIT RAPID FOR PROAIR
PACK 6 ZONES WITH Ø 150
CONNECTIONS AND LINEAR
DIFFUSERS L=1000 MM 2
SLOTS**

THE KIT CONSISTS OF:

- No. 6 linear aluminium diffusers with damper, 2 white slots, length 1000 mm, CODE PWD301634
- 6 insulated universal plenums for linear diffuser 2 slots L 1000 mm 8OD. PWD402591
- 2 double-wall aluminium flexible pipes Ø 152 mm 10 m COD. 11152152
- 1 white aluminium intake grille with filter installation hole 1000 x 500 mm, external measurement 632 x 432 mm COD. WB11161525
- 12 hose clamps

FR **KIT RAPID POUR COMPLÉTER
PROAIR PACK 6 ZONES
AVEC FIXATIONS Ø 150 ET
DIFFUSEURS LINÉAIRES
L=1000 MM 2 FENTES**

LE KIT SE COMPOSE DE:

- N°6 diffuseurs linéaires en aluminium avec registre, 2 fentes de couleur blanche, longueur 1000 mm, CODE PWD301634
- 6 plénums universels isolés pour diffuseur linéaire 2 fentes L 1000 mm CODE PWD402591
- 2 tuyaux flexibles double paroi en aluminium Ø 152 mm 10 m code 11152152
- 1 grille de récupération en aluminium blanc avec filtre à trou d'installation 1000 x 500 mm, taille extérieure 632 x 432 mm code WB11161525
- 12 colliers de serrage

DE **KIT RAPID ALS ERGÄNZUNG
FÜR PROAIR PACK 6 ZONEN
MIT ANSCHLÜSSEN Ø 150 UND
LINEAREN DIFFUSOREN 1000
MM 2 SCHLITZEN**

DER BAUSATZ BESTEHT AUS:

- Nr. 6 lineare Aluminium-Luftauslässe mit Drosselklappe, 2 weiße Schlitze, Länge 1000 mm, CODE PWD301634
- 6 gedämmte Universal-Plenums für lineare Luftdurchlässe 2 Schlitze L 1000 mm COD. PWD402591
- 2 Schläuche doppelwandig, aus Aluminium Ø 152 mm 10 m COD. 11152152
- 1 Ansauggitter aus Aluminium weiß lackiert mit Filter, Einbauöffnung 1000 x 500 Außenmaß 632 x 432 mm COD. WB11161525
- 12 Rohrschellen

NEW

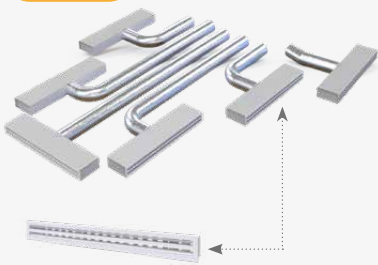

INTAKE GRILLE WITH FILTER
Installation hole 600 x 400 mm

Linear diffuser
in PVC on request

Customisable on request

CODICE	DESCRIZIONE	U.M.	Multiplo d'ordine U.M.
GAD500005	RAPID KIT TO COMPLETE THE PROAIR 6 ZONES WITH Ø150 CONNECTIONS AND 1000 MM 2-SLOTS ALUMINIUM LINEAR DIFFUSERS	KIT	1



KitRapid

HAVEN'T FOUND THE RAPID KIT THAT SUITS YOU?

REQUEST YOUR PERSONALIZED QUOTE THROUGH THE ONLINE FORM.

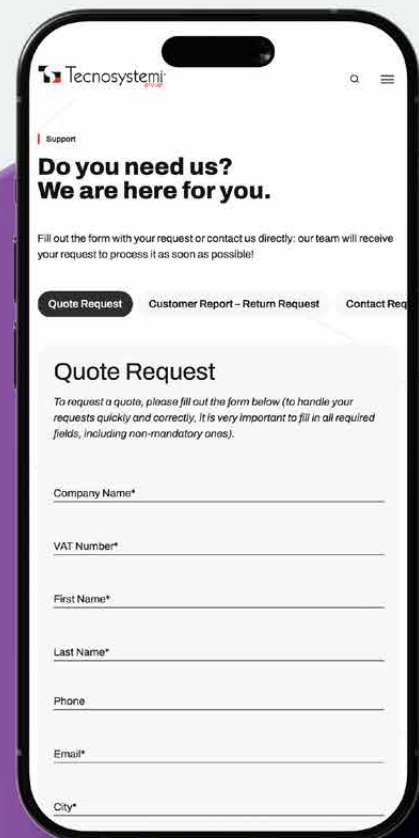

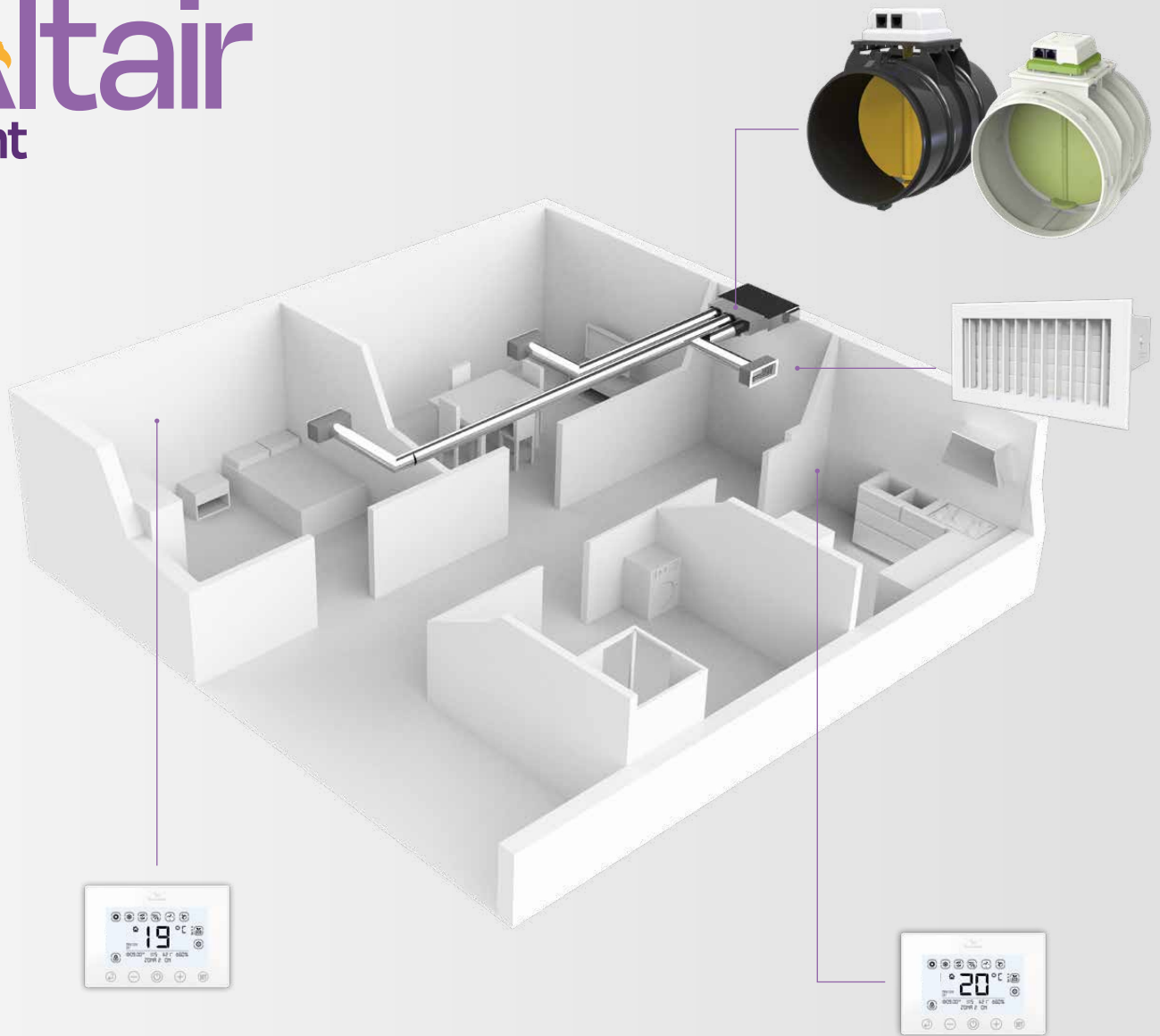

TIMELY TEMPERATURE CONTROL WITH MOTORIZED DAMPER OR GRILLE

The ALTAIR POINT systems allow controlling the temperature in the room without any interaction with the ducted machine or the by-pass system: this is a point-to-point system, which connects a chrono-thermostat to one or more motorized dampers or grilles (up to 10). This solution, that can be implemented in a classic ducted system, allows the customer to control part of these areas by means of an automation.

The installation of a built-in chrono-thermostat from the ALTAIR POINT STEALTH 3X series and of a motorized damper or grille in each of the affected areas will meet the needs of the customer.

GESTION PONCTUELLE DE LA TEMPÉRATURE AVEC REGISTRE OU GRILLE MOTORISÉ

Le système ALTAIR POINT permet de contrôler la température ambiante sans interagir ni avec la machine canalisée ni avec le by-pass : c'est un système point à point, c'est-à-dire directement entre un thermostat programmable et une ou plusieurs fermetures ou grilles motorisées (max 10). Cette solution, applicable à un système canalisé classique, offre au client la possibilité de contrôler une partie de ces zones au moyen d'une automatisation.

L'installation d'un thermostat programmable de la série ALTAIR POINT STEALTH 3X encastré et d'une fermeture ou grille motorisée dans chacune des zones concernées satisfera la demande du client.

ZEITNAHEN STEUERUNG DER TEMPERATUR MIT MOTORISIERTER KLASPE

Das ALTAIR POINT-System ermöglicht die Regelung der Raumtemperatur ohne Interaktion mit dem kanalisierten Gerät oder dem Bypass: Es ist ein Punkt-zu-Punkt-System, d. h. direkt zwischen einem Chrono-Thermostat und einem oder mehreren motorisierten Schiebern oder Lüftungsöffnungen (max 10). Diese Lösung, die auf ein klassisches Kanalsystem anwendbar ist, bietet dem Kunden die Möglichkeit, einen Teil dieser Bereiche mittels einer Automatisierung zu steuern.

Die Installation eines eingebauten Chrono-Thermostats der Serie ALTAIR POINT STEALTH 3X und eines motorisierten Schiebers oder Entlüftung in jedem der betroffenen Bereiche wird dem Wunsch des Kunden gerecht.

INSTALLATION EXAMPLE



1 Altair Point motorised circular damper kit



1 Altair Point motorised delivery grille kit



2 Stealth 3X Altair Point

BUILT-IN WIRED PROGRAMMABLE CHRONOTHERMOSTAT WITH TOUCH STEALTH 3X

TECHNICAL SPECIFICATIONS

- Dimensions W 138 x H 95 x D 40 mm
- Protrusion from flush wall 15 mm
- Built-in mounted on E503 type boxes by means of adapter, screws and fixing plugs supplied
- Power supply and data transmission: 8-pin RJ45 type

THE BUILT-IN POWER SUPPLY IS AVAILABLE ON REQUEST

CHRONOTHERMOSTAT ENCASTRÉ CÂBLE TACTILE STEALTH 3X

CARACTÉRISTIQUES TECHNIQUES

- Dimensions L 138 x H 95 x P 40 mm
- Protubérance à partir du bord du mur 15 mm
- Fixation intégré sur les boîtes de type E503 au moyen d'un adaptateur, de vis et de chevilles fournies

L'ALIMENTATION INTÉGRÉE EST DISPONIBLE SUR DEMANDE

EINBAU-CHRONOTHERMOSTAT VERKABELT MIT TOUCHDISPLAY STEALTH 3X

TECHNISCHE EIGENSCHAFTEN

- Abmessungen B 138 x H 95 x T 40 mm
- Überstand von der Wandkante 15 mm
- Unterputzmontage an Schaltschränken Typ E503 mittels Adapter, Schrauben und Dübel im Lieferumfang enthalten

EINBAU-STROMVERSORGUNG AUF ANFRAGE ERHÄLTICH

Compatible with Altair Point series actuators.

ATTENZIONE!
It is not possible to control air diffusers and dampers simultaneously with the same thermostat. For the connection cables, see page 24 of the Galaxy catalog. Do not use LAN network cables.



CODE	DESCRIPTION	U.M.	Pieces per box
11181454	LUMIX WHITE, BUILT-IN, CABLED, PROGRAMMABLE THERMOSTAT - "STEALTH 3X - POINT"	PCS	1



 **MOTORIZED CIRCULAR DAMPER KIT**

TECHNICAL SPECIFICATIONS

The motorised circular damper is powered directly by the cable-programmable thermostat and controls the throttle adjustment in one of the 4 possible positions: 0%, 33%, 66% and 100%, both in automatic and ON / OFF management.

Made of plastic material, it guarantees thermal insulation between the inner and outer surface avoiding condensation phenomena during summer operation.

MADE OF ANTI-CONDENSATION ABS

 **KIT FERMETURE CIRCULAIRE MOTORISÉE**

CARACTÉRISTIQUES TECHNIQUES

Le registre circulaire motorisé est alimenté directement par le **chronothermostat** et le câble, il commande le réglage du papillon dans l'une des 4 positions possibles : 0%, 33%, 66% et 100%, à la fois en gestion automatique que ON/OFF.

Fabriquée en matière plastique, elle **garantit une isolation thermique** entre la surface intérieure et la surface extérieure en évitant les phénomènes de condensation pendant le fonctionnement d'été.

FABRIQUÉ EN ABS ANTI-CONDENSATION

 **MOTORISIERTE RUNDE Klappe**

TECHNISCHE EIGENSCHAFTEN

Die motorisierte Kreisklappe wird direkt vom kabelprogrammierbaren Thermostat angetrieben und steuert die Drosselklappenverstellung in einer der 4 möglichen Positionen: 0%, 33%, 66% und 100%, sowohl im automatischen als auch im ON /OFF-Verwaltung.

Es besteht aus Kunststoff und gewährleistet eine thermische Isolierung zwischen Innen- und Außenfläche, wodurch Kondensatbildung im Sommerbetrieb vermieden werden.

AUS ANTIKONDENSATIONS-ABS



*Only Ø 150-200

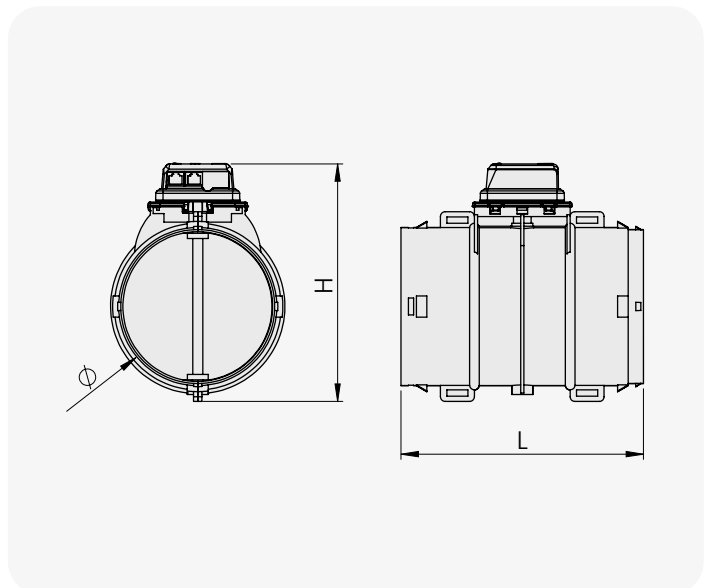

FOR FIXING COLLAR PAGE 19-20

ATTENTION!

- The dampers of the "ALTAIR POINT SYSTEM" only work with built-in "STEALTH 3X" cab touch screen programmable thermostats for altair point (see page 71)
- Use always the 8-wire telephone cable with plug RJ45 6 mt supplied in the kit. Regarding connection cable refer to page 24 of the catalogue Galaxy. Do not use any lan cables.

CODE	Ø COUPLING A	H	LENGHT	MAX AIR FLOW	U.M.	 Pieces per box
	[mm]		[mm]	[m³/h]		
11181551	100	230	360	152	PCS	1
*GAD300019	150	230	230	388	PCS	1
*GAD300020	200	280	250	678	PCS	1
11181566	250	330	280	1060	PCS	1
11181571	300	380	350	1526	PCS	1



**WHITE MOTORISED DELIVERY
GRILLE KIT INCLUDING
GASKET**

TECHNICAL SPECIFICATIONS

The motorised rectangular grille is powered directly by the cable programmable thermostat and controls the adjustment of the horizontal flaps in one of the 4 possible positions: 0%, 33%, 66% and 100%, both in automatic and ON / OFF management.

The soft rubber gasket on each flap ensures maximum air tightness when the air passes with the grille closed, avoiding whistling or noise.

**KIT GRILLE DE DISTRIBUTION
MOTRISÉE BLANCHE AVEC
JOINT**

CARACTÉRISTIQUES TECHNIQUES

La grille rectangulaire motorisée est alimentée directement par le thermostat programmable par câble et commande le réglage des ailettes horizontales dans l'une des 4 positions possibles : 0%, 33%, 66% et 100%, à la fois en gestion automatique que ON/OFF.

Le joint en caoutchouc souple sur chaque ailette assure une étanchéité maximale à l'air lorsque l'air passe avec la grille fermée, évitant ainsi le sifflement ou le bruit.

**WEISSES MOTORISIERTES
ABGABEDÜSENSET MIT
DICHTUNG**

TECHNISCHE EIGENSCHAFTEN

Die motorisierte rechteckige Düse wird direkt vom kabelprogrammierbaren Thermostat angetrieben und steuert die Einstellung der horizontalen Lamellen in einer der 4 möglichen Positionen: 0%, 33%, 66% und 100%, sowohl im automatischen als auch im ON / OFF-Verwaltung.

Die weiche Gummidichtung an jede Lamelle sorgt für maximale Luftdichtigkeit, wenn die Luft bei geschlossener Düse passiert, um Pfeifen oder Lärm zu vermeiden.

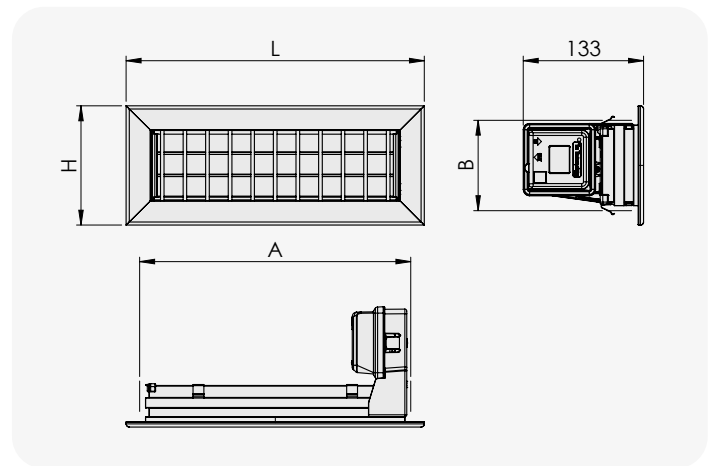

FOR FIXING COLLAR PAGE 19-20

ATTENTION!

- The dampers of the "ALTAIR POINT SYSTEM" only work with built-in "STEALTH 3X" cab touch screen programmable thermostats for altair point (see page 71)
 - Use always the 8-wire telephone cable with plug RJ45 6 mt supplied in the kit. Regarding connection cable refer to page 24 of the catalogue Galaxy.
- Do not use any lan cables.

CODE	DIMENSIONS [mm]				MAX AIR FLOW [m³/h]	SPEED [m/s]	U.M.	Pieces per box
	A	B	L	H				
11181683	300	100	332	132	400	6,9	PCS	1
11181685	300	150	332	182	500	5,8	PCS	1
11181687	300	200	332	232	900	6,2	PCS	1
11181689	400	100	432	132	500	5,8	PCS	1
11181691	400	150	432	182	900	6,2	PCS	1
11181693	400	200	432	232	1200	6,8	PCS	1
11181695	500	100	532	132	700	6,2	PCS	1
11181697	500	150	532	182	1200	6,8	PCS	1



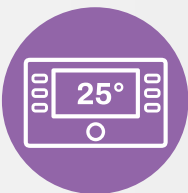
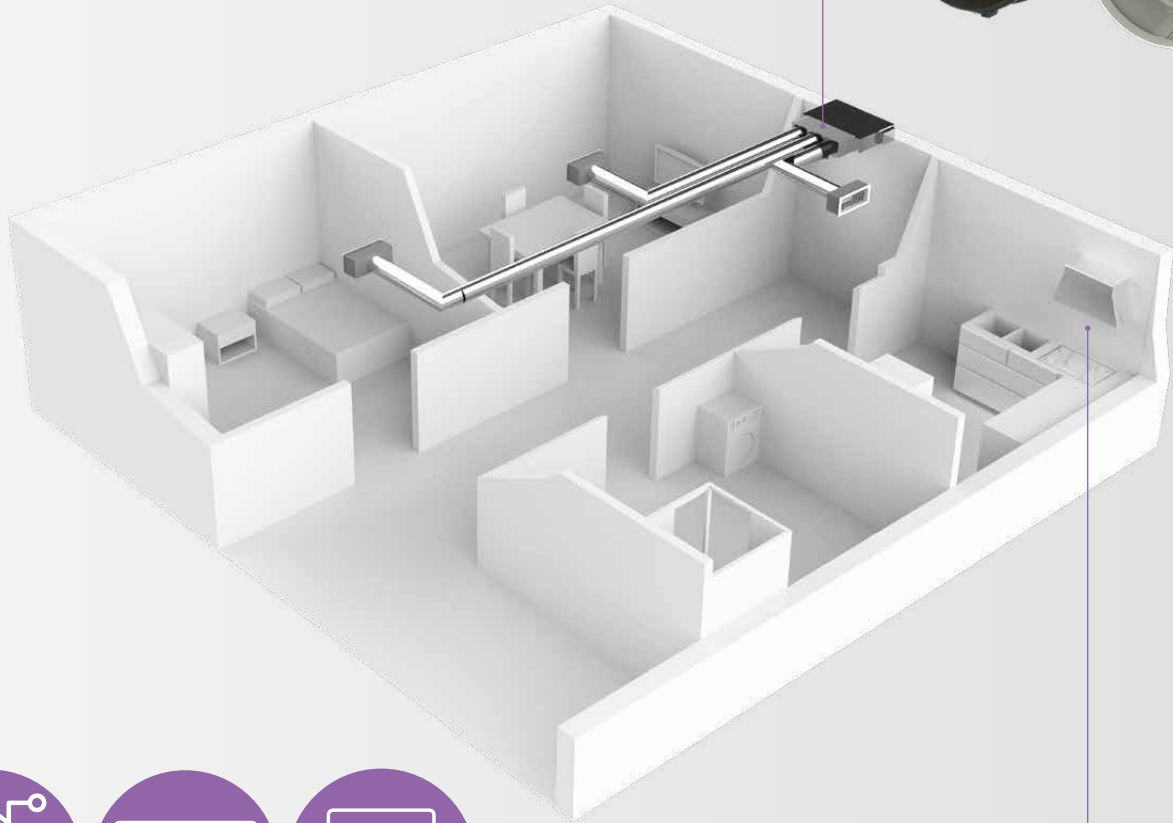

IT WORKS WITH



MOTORIZED BUTTERFLY DAMPER FOR POINT SYSTEM

The SIRIO 2.0 Point allows the management of the temperature or air flow for each room, without the aid of any control unit or a particular command.

The motorised circular damper integrates perfectly with new and existing ducted systems in which it is necessary to manage only part of the ducted system: this solution does not require the installation of any system that manages the switching on/off of the internal unit or the movement of the motorised bypass. It therefore allows management of the air flow in the individual rooms without the aid of an electronic control unit for operation. It is equipped with auxiliary on/off input and output contacts. It can be controlled by thermostats, on/off switches or integration with home automation system by means of open contact.



FERMETURE CIRCULAIRE MOTORISÉE À PAPILLON POUR SYSTÈME PONCTUEL

Le SIRIO 2.0 Point permet la gestion de la température ou du débit d'air par pièce, sans l'aide d'une unité de commande ou d'une commande particulière.

La fermeture circulaire motorisée s'intègre parfaitement aux systèmes de goulottes neufs et existants dans lesquels on ne souhaite gérer qu'une partie du système de goulottes : cette solution ne nécessite l'installation d'aucun système qui gère la mise en marche/arrêt de l'unité intérieure ou le mouvement de la dérivation motorisée. Permet ainsi la gestion du flux d'air dans chaque pièce sans l'aide d'une unité électronique de commande pour le fonctionnement. Il est doté de contacts auxiliaires de type on/off en entrée et sortie. peut être commandé par des thermostats, des interrupteurs marche/arrêt ou l'intégration avec le système domotique au moyen d'un contact propre.



MOTORISIERTE KREISKLAPPE FÜR POINT SYSTEM

Das SIRIO 2.0 Point ermöglicht die Steuerung der Temperatur oder des Luftstroms pro Raum, ohne die Hilfe eines Steuergeräts oder eines bestimmten Befehls.

Der motorisierte Kreisklappen lässt sich perfekt in neue und bestehende Leitungssysteme integrieren, in denen Sie nur einen Teil des Leitungssystems verwalten möchten: diese Lösung erfordert keine Installation eines Systems, welches das Ein-/Ausschalten des Innengeräts oder die Bewegung des motorisierten Bypasses verwaltet. Sie ermöglicht somit die Steuerung des Luftstroms in den einzelnen Räumen ohne Zuhilfenahme einer elektronischen Steuereinheit für den Betrieb. Es ist mit Ein-/Aus-Hilfskontakten im Ein- und Ausgang ausgestattet. Es kann durch Thermostate, Ein-/Ausschalter oder die Integration mit dem Hausautomationssystem durch sauberen Kontakt gesteuert werden.

INSTALLATION EXAMPLE



1 Sirio 2.0 Point motorised circular damper kit



1 on / off switch

MOTORISED BUTTERFLY DAMPER IN PLASTIC MATERIAL

TECHNICAL SPECIFICATIONS

- ABS plastic
- Auxiliary IN/OUT contact
- Power supply: 230 V
- Power supply included ("MASTER" version)
- "SLAVE" version without power supply
- Opening butterfly ON / OFF
- Operating temperature 0°C A +70°C
- Max conveyance length 25 m
- A maximum of 8 dampers can be installed in ducting

FERMETURE CIRCULAIRE MOTORISÉE À PAPILLON EN PLASTIQUE POUR SYSTÈME PONCTUEL

CARACTÉRISTIQUES TECHNIQUES

- Plastique ABS
- Contact auxiliaire ENTRÉE/SORTIE
- Alimentation : 230 V
- Bloc d'alimentation inclus (version « MASTER »)
- Version « SLAVE » sans alimentation électrique
- Ouverture papillon ON / OFF
- Température de fonctionnement 0°C A +70°C
- Longueur maximale de la caténaire 25 m
- 8 registres maximum peuvent être installés dans la caténaire

MOTORISIERTE KREISKLAPPE KUNSTSTOFF FÜR POINT SYSTEM

TECHNISCHE EIGENSCHAFTEN

- ABS-Kunststoff
- Zusätzlicher IN/OUT-Kontakt
- Versorgung: 230 V
- Netzteil im Lieferumfang enthalten (Version "MASTER")
- SLAVE-Version ohne Stromversorgung
- Öffnungsklappe EIN / AUS
- Betriebstemperatur 0°C bis +70°C
- Max. Kettenlinienlänge 25 m
- Es können maximal 8 Klappen in der Kettenlinie installiert werden

FOR FIXING COLLAR PAGE 19-20

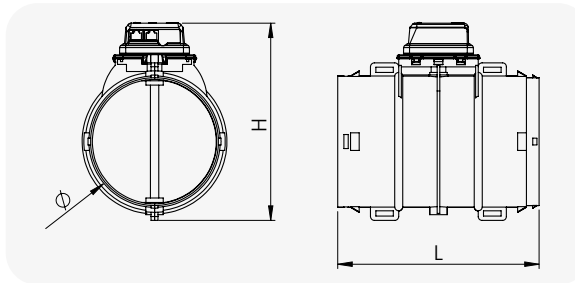

ATTENTION!
Always provide the inspection hatch to access the dampers. For cable connections between "master" and "slave" dampers see page 24

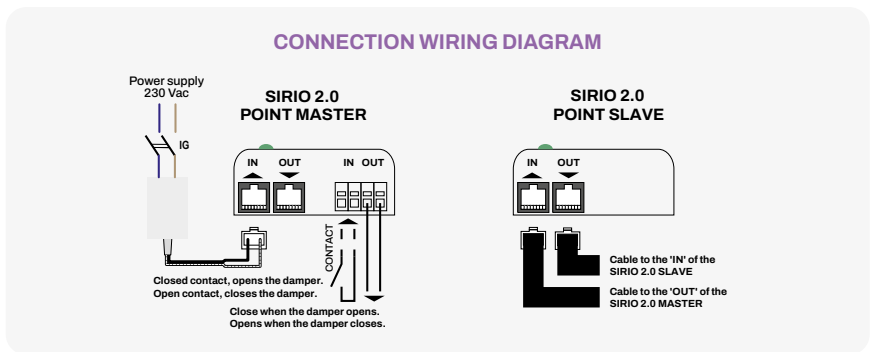

CODE	DESCRIPTION	DIMENSIONS [mm]			MAX AIR FLOW [m³/h]	U.M.	Pieces per box
		H	L	Ø			
GAD300001	ELECTRIC BUTTERFLY "SIRIO 2.0" - Ø 100 - MASTER	230	315	100	152	PCS	1
GAD300002	ELECTRIC BUTTERFLY "SIRIO 2.0" - Ø 150 - MASTER	230	230	150	388	PCS	1
GAD300003	ELECTRIC BUTTERFLY "SIRIO 2.0" - Ø 200 - MASTER	280	250	200	678	PCS	1
GAD300004	ELECTRIC BUTTERFLY "SIRIO 2.0" - Ø 250 - MASTER	330	280	250	106	PCS	1
GAD300005	ELECTRIC BUTTERFLY "SIRIO 2.0" - Ø 300 - MASTER	380	350	300	1526	PCS	1
GAD300007	ELECTRIC BUTTERFLY "SIRIO 2.0" - Ø 100 - SLAVE	230	315	100	152	PCS	1
GAD300008	ELECTRIC BUTTERFLY "SIRIO 2.0" - Ø 150 - SLAVE	230	230	150	388	PCS	1
GAD300009	ELECTRIC BUTTERFLY "SIRIO 2.0" - Ø 200 - SLAVE	280	250	200	678	PCS	1
GAD300010	ELECTRIC BUTTERFLY "SIRIO 2.0" - Ø 250 - SLAVE	330	280	250	1060	PCS	1
GAD300011	ELECTRIC BUTTERFLY "SIRIO 2.0" - Ø 300 - SLAVE	380	350	300	1526	PCS	1



Sirio 0.10v

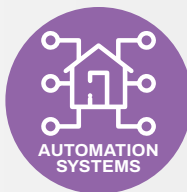
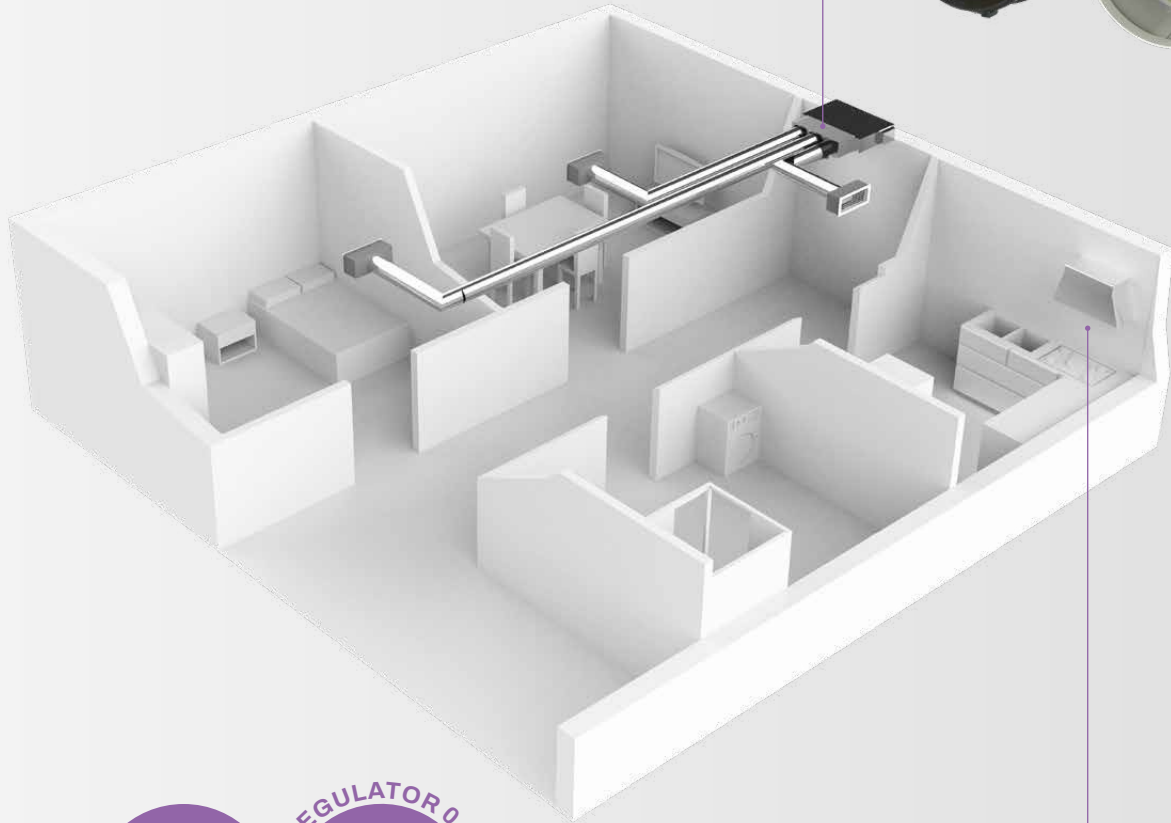

IT WORKS WITH

🇬🇧 MOTORISED BUTTERFLY DAMPER FOR POINT SYSTEM

The SIRIO 0.10V damper allows the management of the temperature or air flow in each individual room, without the aid of any control unit.

The sirio 0.10v point motorised circular damper integrates perfectly with new and existing ducted systems in which only part of the ducted system is to be managed: this solution does not require the installation of any system that manages the switching on / off of the indoor unit or the movement of a motorised bypass. It allows the management of the air flow in the individual rooms by applying a 0-10v regulator (easily available on the market) to each single sirio 0.10v point damper present in the system: to manage the switching on and off of the ducted units, just use the on/off output auxiliary contacts.

🇫🇷 FERMETURE CIRCULAIRE MOTORISÉE À PAPILLON POUR SYSTÈME PONCTUEL

La fermeture SIRIO 0.10V permet la gestion de la température ou du débit d'air d'une seule pièce, sans l'aide d'aucune centrale de commande.

La fermeture circulaire motorisée sirio 0.10v point s'intègre parfaitement dans les systèmes canalisés neufs et existants dans lesquels seule une partie du système canalisé doit être géré : cette solution ne nécessite l'installation d'aucun système gérant l'allumage/extinction de l'unité intérieure ou le mouvement d'un bypass motorisé. permet la gestion du débit d'air dans chaque pièce en appliquant un régulateur 0-10v (facilement disponible sur le marché) à chaque fermeture individuelle sirio 0.10v point présente dans le système : s'il est également destiné à gérer l'allumage et l'arrêt de l'unité canalisée, il suffira d'utiliser les contacts auxiliaires on/off en sortie.

🇩🇪 MOTORISIERTE KREISKLAPPE FÜR POINT SYSTEM

Der Schieber SIRIO 0.10V ermöglicht die Steuerung der Temperatur oder des Luftdurchsatzes für einen einzelnen Raum ohne die Hilfe einer Steuereinheit.

Der motorisierte Rundschieber Sirio 0.10V Point lässt sich perfekt in neue und bestehende Kanalsysteme integrieren, in denen nur ein Teil des Kanalsystems verwaltet werden soll: diese Lösung erfordert keine Installation eines Systems, das das Ein- und Ausschalten des Innengeräts verwaltet oder die Bewegung eines motorisierten Bypasses. Sie ermöglicht die Steuerung des Luftstroms in den einzelnen Räumen durch Anlegen eines Reglers 0-10 V (im Handel erhältlich) und Anlegen an jeden einzelnen in der Anlage vorhandenen Schieber Sirio 0.10V Point: wenn er auch zum Ein- und Ausschalten der gemultiplexten Einheit vorgesehen ist, ist es ausreichend, die Ein/Aus-Hilfskontakte am Ausgang zu verwenden.

INSTALLATION EXAMPLE



1 Sirio 0.10v motorised circular damper

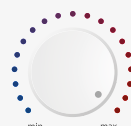

1 Regulator 0.10V

MOTORISED BUTTERFLY DAMPER IN PLASTIC MATERIAL

TECHNICAL SPECIFICATIONS

- ABS plastic
- Built-in power supply included
- OUT contact: ON/OFF (closed, butterfly valve open) (open, butterfly valve closed)
- Input: 0-10V (regulator not supplied and not listed in the catalogue)
- Operating temperature 0°C A +70°C
- Available in 5Ø

FERMETURE CIRCULAIRE MOTORISÉE À PAPILLON EN PLASTIQUE POUR SYSTÈME PONCTUEL

CARACTÉRISTIQUES TECHNIQUES

- Plastique ABS
- Bloc d'alimentation intégré inclus
- Contact OUT : ON/OFF (fermé, papillon ouvert) (ouvert, papillon fermé)
- Entrée : 0-10V (régulateur non fourni et non disponible au catalogue)
- Température de fonctionnement 0°C A +70°C
- Disponible en 5Ø

MOTORISIERTE KREISKLAPPE KUNSTSTOFF FÜR POINT SYSTEM

TECHNISCHE EIGENSCHAFTEN

- ABS-Kunststoff
- Integriertes Netzteil im Lieferumfang enthalten
- OUT-Kontakt: EIN / AUS (geschlossen, Drosselklappe offen) (offen, Drosselklappe geschlossen)
- Eingang: 0-10V (Regler nicht im Lieferumfang enthalten und nicht im Katalog verfügbar)
- Betriebstemperatur 0°C bis +70°C
- Erhältlich in 5Ø

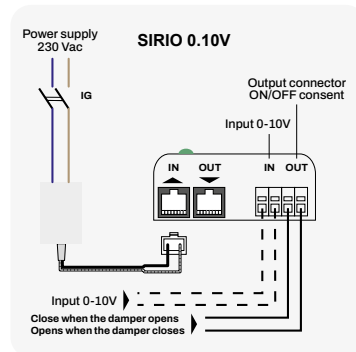
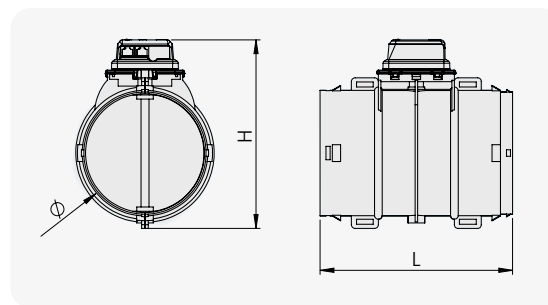

FOR FIXING COLLAR PAGE 19-20

ATTENTION!

Always provide the inspection hatch to access the damper

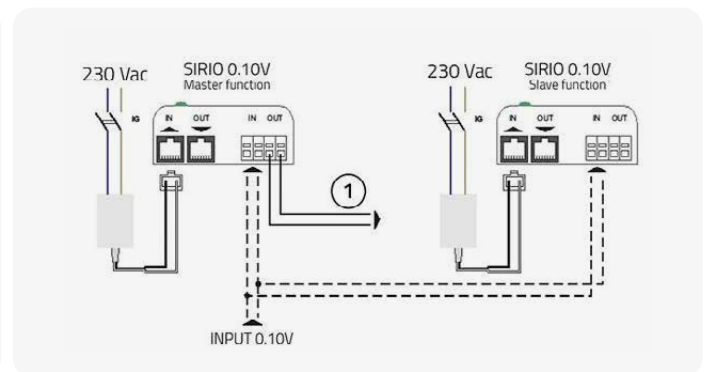
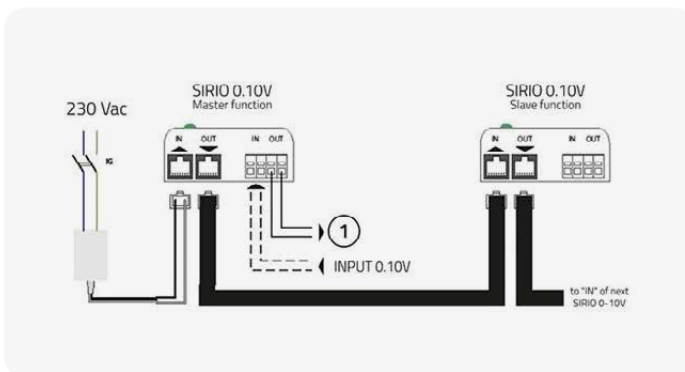

CODE	DESCRIPTION	DIMENSIONS [mm]			MAX AIR FLOW [m³/h]	U.M.	Pieces per box
		H	L	Ø			
GAD300014	MOTORISED CIRCULAR DAMPER SIRIO 0.10V - Ø 100	230	315	100	152	PCS	1
*GAD300015	MOTORISED CIRCULAR DAMPER SIRIO 0.10V - Ø 150	230	230	150	388	PCS	1
*GAD300016	MOTORISED CIRCULAR DAMPER SIRIO 0.10V - Ø 200	280	250	200	678	PCS	1
GAD300017	MOTORISED CIRCULAR DAMPER SIRIO 0.10V - Ø 250	330	280	250	1060	PCS	1
GAD300018	MOTORISED CIRCULAR DAMPER SIRIO 0.10V - Ø 300	380	350	300	1526	PCS	1



Sirio 2.0

pack point

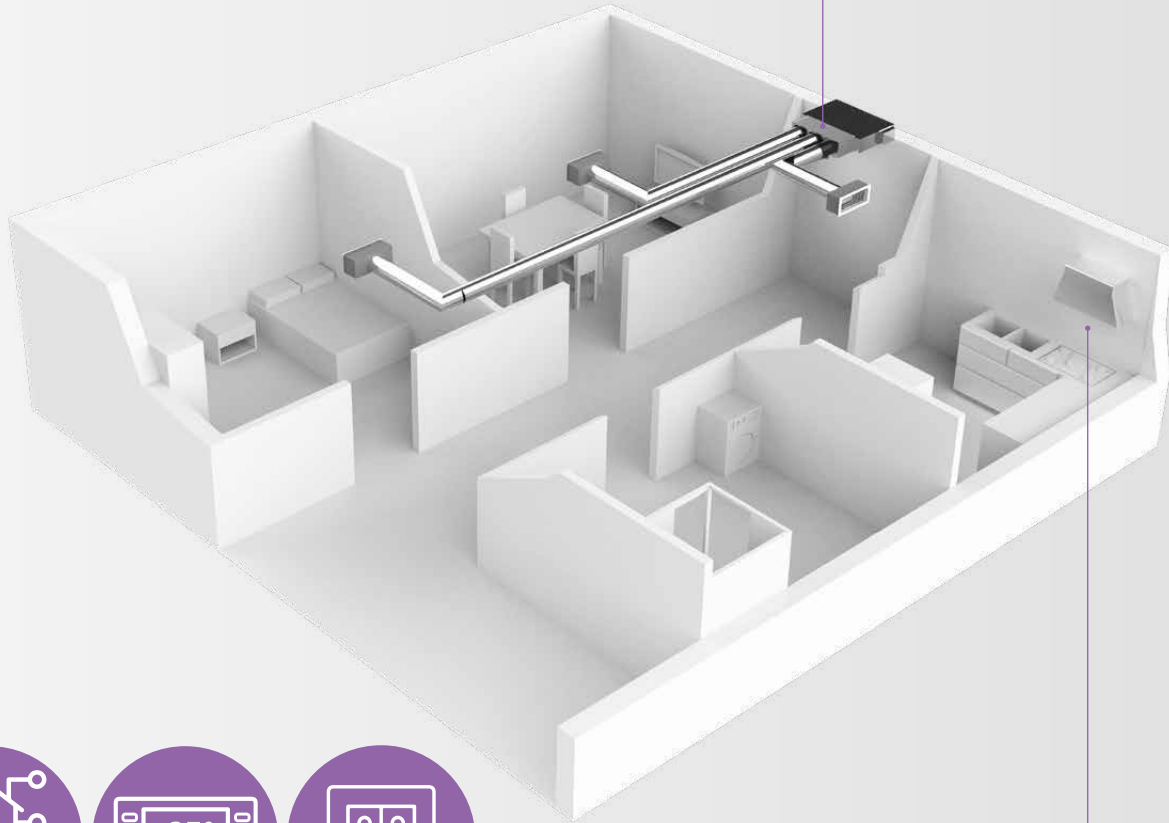

IT WORKS WITH

PLENUM COMPLETE WITH MOTORIZED BUTTERFLY DAMPERS FOR POINT SYSTEM

The SIRIO 2.0 Pack Point dampers applied to plenums for ducted units available in the tecnosystemi catalogue allow management of the air flow and temperature in the rooms where an air conditioning system is installed.

The clean contact on each sirio 2.0 point damper allows the ducts to be switched on and off. The sirio 2.0 pack points include as standard the built-in power supply for each damper and the mechanical bypass to be installed to the right or left of the plenum to avoid possible overpressure situations. The sirio 2.0 pack points can be made with all types of plenums produced by tecnosystemi: eolo mini / eolo, electro-galvanised sheet metal and pal (plenum in pal available on request)

PLÉNUM ÉQUIPÉ DE FERMETURES MOTORISÉES À PAPILLON POUR SYSTÈME PONCTUEL

Les fermeture SIRIO 2.0 Pack Point appliquées aux plenums pour unités canalisées disponibles dans le catalogue tecnosystemi, permettent la gestion du débit d'air et de la température dans les environnements dans lesquels un système de climatisation est installé.

Le contact propre de chaque registre sirio 2.0 point permet d'allumer et d'éteindre les conduits. Les sirio 2.0 pack point comprennent en série l'alimentation électrique intégrée pour chaque registre et la dérivation mécanique à installer à droite ou à gauche du plenum pour éviter d'éventuelles situations de surpression. Les sirio 2.0 pack point peuvent être réalisés avec tous les types de plenums produits par tecnosystemi : eolo mini / eolo, feuille électro-galvanisée et pal (plenum en pal disponible sur demande).

PLENUM EINSCHLIESSLICH MIT MOTORISIERTER DROSSELKlappe FÜR POINT SYSTEM

Die Klappen SIRIO 2.0 Pack Point, die an den im Tecnosystemi-Katalog erhältlichen Luftverteilern für Kanalgeräte angebracht werden, ermöglichen die Steuerung des Luftstroms und der Temperatur in den Räumen, in denen ein Klimasystem installiert ist.

Der potentialfreie Kontakt an jeder Klappe Sirio 2.0 Point ermöglicht das Ein- und Ausschalten der Kanäle. Die Sirio 2.0 Pack Points enthalten standardmäßig die eingebaute Stromversorgung für jede Klappe und den mechanischen Bypass, der rechts oder links vom Plenum installiert wird, um mögliche Überdrucksituationen zu vermeiden. Sirio 2.0 Pack Punkte können mit allen Arten von Plenums von Tecnosystemi realisiert werden: Eolo Mini/Eolo, galvanisiertes Blech und PAL (Plenum in PAL auf Anfrage erhältlich).

INSTALLATION EXAMPLE



1 Plenum Eolo 3 zone motorised damper SIRIO PACK 2.0 POINT



1 on / off switch

MOTORISED CIRCULAR DAMPER IN PLASTIC MATERIAL

ERMETURE CIRCULAIRE MOTORISÉE EN PLASTIQUE

MOTORISIERTE KREISKLAPPE KUNSTSTOFF

TECHNICAL SPECIFICATIONS

- "Eolo Mini" Ø 125/150 mm 3 and 4 zones
- "Eolo Mini" Ø 150/200 mm 2, 3, 4 and 5 zones
- metal sheet Ø 150 mm e Ø 200 mm 2, 3, 4, 5 e 6 zones
- PAL Ø 150 mm and Ø 200 mm zones 2, 3, 4, 5 and 6 (for quotes for PAL plenum boxes call freephone).
- Overpressure bypass supplied but not installed
- Ducted unit ON/off control (check if interface use is required)
- Can be managed using any ON/OFF control for opening and closing the damper

CARACTÉRISTIQUES TECHNIQUES

- « Eolo Mini » Ø 125/150 mm 3 et 4 zones
- « Eolo Mini » Ø 150/200 mm 2, 3, 4 et 5 zones
- Tôle Ø 150 mm e Ø 200 mm 2, 3, 4, 5 e 6 zones
- PAL Ø 150 mm et Ø 200 mm 2, 3, 4, 5 et 6 zones (pour les devis des plenums PAL appelez le numéro sans frais).
- By-pass de surpression fourni mais non installé
- Contrôle marche/arrêt de l'unité gainée (vérifier la nécessité d'utiliser l'interface)
- Il est géré par n'importe quelle commande ON/OFF pour ouvrir et fermer le registre

TECHNISCHE EIGENSCHAFTEN

- „Eolo Mini“ Ø 125/150 mm 3 und 4 Zonen
- „Eolo Mini“ Ø 150/200 mm 2, 3, 4 und 5 Zonen
- Blech Ø 150 mm e Ø 200 mm 2, 3, 4, 5 e 6 zonen
- PAL Ø 150 mm und Ø 200 mm 2, 3, 4, 5 und 6 Zonen (Angebote für PAL-Plenums erhalten Sie unter der kostenlosen Rufnummer).
- Überdruck-Bypass mitgeliefert, aber nicht installiert
- EIN-/AUS Kontrolle der kanalisiertem Einheit (überprüfen, ob die Schnittstelle verwendet werden muss)
- Gesteuert durch eine beliebige ON/OFF-Steuerung zum Öffnen und Schließen der Klappe



The delivery plenum for ducted unit is included in the price (please specify at the moment of order the code of plenum, see this catalog starting from pag.48)

4 ZONE SIRIO 2.0 PACK POINT CONNECTION WIRING DIAGRAM

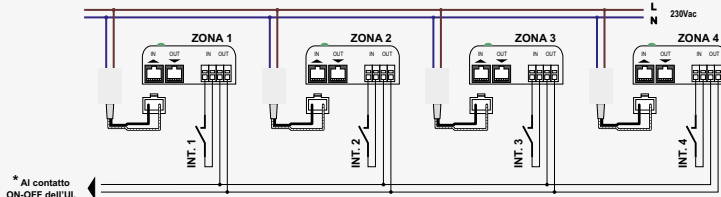

ATTENTION!

The Sirio 2.0 pack point systems include the dampers installed and relative testing. The chronothermostats or push-button panels are not included in the price.

CHRONOTHERMOSTAT NOT INCLUDED

CHRONOTHERMOSTAT INCLUDED

CODE	DESCRIPTION	U.M.	Pieces per box	CODE	DESCRIPTION	U.M.	Pieces per box
GAD600003	SIRIO 2.0 PACK 3 EOLO MINI	PCS	1	GAD600019	SIRIO 2.0 PACK 3 EOLO MINI WITH SMART SIRIO CHRONOTERMOSTAT	PCS	1
GAD600004	SIRIO 2.0 PACK 3 EOLO MINI	PCS	1	GAD600020	SIRIO 2.0 PACK 4 EOLO MINI WITH SMART SIRIO CHRONOTERMOSTAT	PCS	1
GAD600005	SIRIO 2.0 PACK 2 EOLO	PCS	1	GAD600021	SIRIO 2.0 PACK 2 EOLO WITH SMART SIRIO CHRONOTERMOSTAT	PCS	1
GAD600006	SIRIO 2.0 PACK 3 EOLO	PCS	1	GAD600022	SIRIO 2.0 PACK 3 EOLO WITH SMART SIRIO CHRONOTERMOSTAT	PCS	1
GAD600007	SIRIO 2.0 PACK 4 EOLO	PCS	1	GAD600023	SIRIO 2.0 PACK 4 EOLO WITH SMART SIRIO CHRONOTERMOSTAT	PCS	1
GAD600008	SIRIO 2.0 PACK 5 EOLO	PCS	1	GAD600024	SIRIO 2.0 PACK 5 EOLO WITH SMART SIRIO CHRONOTERMOSTAT	PCS	1
GAD600009	SIRIO 2.0 PACK 2 SHEET METAL Ø 150	PCS	1	GAD600025	SIRIO 2.0 PACK 2 Ø150 SHEET WITH SMART SIRIO CHRONOTERMOSTAT	PCS	1
GAD600010	SIRIO 2.0 PACK 3 SHEET METAL Ø 150	PCS	1	GAD600026	SIRIO 2.0 PACK 3 Ø150 SHEET WITH SMART SIRIO CHRONOTERMOSTAT	PCS	1
GAD600011	SIRIO 2.0 PACK 4 SHEET METAL Ø 150	PCS	1	GAD600027	SIRIO 2.0 PACK 4 Ø150 SHEET WITH SMART SIRIO CHRONOTERMOSTAT	PCS	1
GAD600012	SIRIO 2.0 PACK 5 SHEET METAL Ø 150	PCS	1	GAD600028	SIRIO 2.0 PACK 5 Ø150 WITH SMART SIRIO CHRONOTERMOSTAT	PCS	1
GAD600013	SIRIO 2.0 PACK 6 SHEET METAL Ø 150	PCS	1	GAD600029	SIRIO 2.0 PACK 6 Ø150 SHEET WITH SMART SIRIO CHRONOTERMOSTAT	PCS	1
GAD600014	SIRIO 2.0 PACK 2 SHEET METAL Ø 200	PCS	1	GAD600030	SIRIO 2.0 PACK 2 Ø200 SHEET WITH SMART SIRIO CHRONOTERMOSTAT	PCS	1
GAD600015	SIRIO 2.0 PACK 3 SHEET METAL Ø 200	PCS	1	GAD600031	SIRIO 2.0 PACK 2 Ø200 SHEET WITH SMART SIRIO CHRONOTERMOSTAT	PCS	1
GAD600016	SIRIO 2.0 PACK 4 SHEET METAL Ø 200	PCS	1	GAD600032	SIRIO 2.0 PACK 4 Ø200 SHEET WITH SMART SIRIO CHRONOTERMOSTAT	PCS	1
GAD600017	SIRIO 2.0 PACK 5 SHEET METAL Ø 200	PCS	1	GAD600033	SIRIO 2.0 PACK 5 Ø200 SHEET WITH SMART SIRIO CHRONOTERMOSTAT	PCS	1
GAD600018	SIRIO 2.0 PACK 6 SHEET METAL Ø 200	PCS	1	GAD600034	SIRIO 2.0 PACK 6 Ø200 SHEET WITH SMART SIRIO CHRONOTERMOSTAT	PCS	1

Sirio 0.10v pack

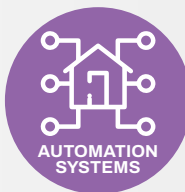
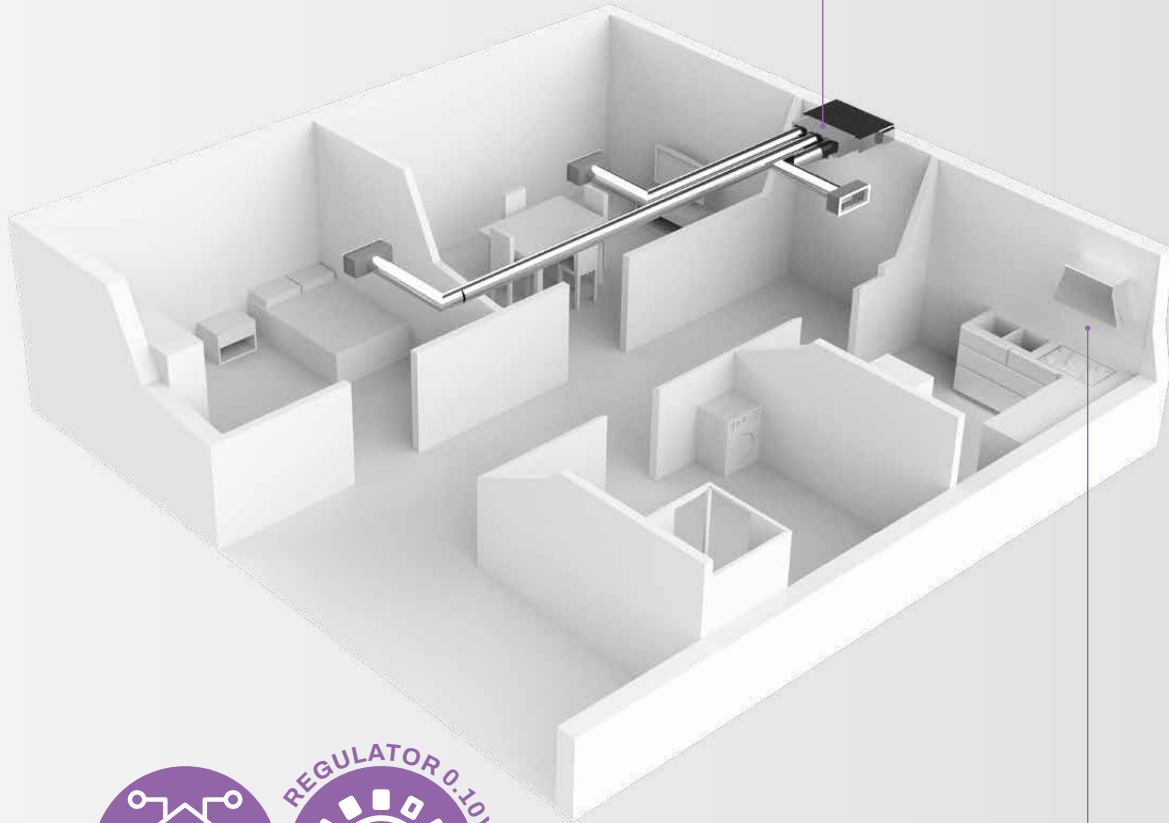

IT WORKS WITH

🇬🇧 PLENUM COMPLETE WITH MOTORISED BUTTERFLY DAMPERS FOR POINT SYSTEM

The SIRIO 0.10V Pack dampers installed on a delivery plenum for ducted units allow the use of the "sirio 0-10v pack point" system, designed for the management of areas within an air conditioning system.

The sirio 0-10v pack point system allows controlling the opening, closing and partialisation of the butterfly valves of the dampers via the 0-10v regulator of a domotic system. If all dampers are closed, the ducted unit may be turned off via the clean contact at output of each motor of the sirio 0-10v point damper. The clean contact on each sirio 0-10v point damper allows adjusting the butterfly valve and turning on and off the ducted unit.

🇫🇷 PLÉNUM ÉQUIPÉ DE FERMETURES MOTORISÉES À PAPILLON POUR SYSTÈME PONCTUEL

Les fermetures SIRIO 0.10V Pack installées sur un plénum de refoulement pour appareils canalisés, permettent d'utiliser le système « sirio 0-10v pack point », destiné à la gestion des zones d'un système de climatisation.

Le système sirio 0.10v pack point permet le contrôle de l'ouverture, de la fermeture et de la partialisation du papillon des fermetures au moyen du régulateur 0-10v d'un système domotique. En cas de fermeture complète de toutes les fermetures, il est possible d'éteindre la machine canalisée à l'aide du contact de sortie propre présent sur chaque moteur du sirio 0-10v point. Le contact propre sur chaque fermeture sirio 0-10v point permet de régler le papillon, l'activation et la désactivation du conduit.

🇩🇪 PLENUM EINSCHLIESSLICH MIT MOTORISIERTER DROSSELKlappe FÜR POINT SYSTEM

Der Schieber SIRIO 0,10 V Pack, die auf einem Druckplenum für Kanalgeräte installiert sind, ermöglichen Ihnen die Verwendung des „Sirio 0-10 V Pack Point“-Systems, das für die Verwaltung der Zonen in einem Klimaanlage system entwickelt wurde.

Das System Sirio 0,10 V Pack Point ermöglicht die Steuerung des Öffnens, Schließens und der Teilung der Drosselklappe des Schiebers mit Hilfe des Reglers 0-10 V eines Hausautomationssystems. Im Falle einer vollständigen Schließung aller Schieber ist es möglich, das kanalisierte Gerät über den sauberen Ausgangskontakt an jedem Motor des Sirio 0-10 V Point auszuschalten. Der potentialfreie Kontakt an jedem Sirio-Schieber 0-10 V Point ermöglicht das Einstellen der Drosselklappe, das Ein- und Ausschalten des Kanals.

INSTALLATION EXAMPLE



1 Sirio 0.10V motorised circular damper

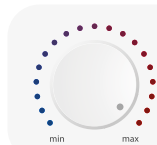

1 Regulator 0.10V

MOTORISED BUTTERFLY DAMPER IN PLASTIC MATERIAL

TECHNICAL SPECIFICATIONS

- ABS plastic
- Built-in power supply included
- OUT contact: ON/OFF (closed, butterfly valve open) (open, butterfly valve closed)
- Input: 0-10V (regulator not supplied and not listed in the catalogue)
- Operating temperature 0°C A +70°C
- Available in 5Ø

FERMETURE CIRCULAIRE MOTORISÉE À PAPILLON EN PLASTIQUE POUR SYSTÈME PONCTUEL

CARACTÉRISTIQUES TECHNIQUES

- Plastique ABS
- Bloc d'alimentation intégré inclus
- Contact OUT : ON/OFF (fermé, papillon ouvert) (ouvert, papillon fermé)
- Entrée : 0-10V (régulateur non fourni et non disponible au catalogue)
- Température de fonctionnement 0°C A +70°C
- Disponible en 5Ø

MOTORISIERTE KREISKLAPPE KUNSTSTOFF FÜR POINT SY-STEM

TECHNISCHE EIGENSCHAFTEN

- ABS-Kunststoff
- Integriertes Netzteil im Lieferumfang enthalten
- OUT-Kontakt: EIN / AUS (geschlossen, Drosselklappe offen) (offen, Drosselklappe geschlossen)
- Eingang: 0-10V (Regler nicht im Lieferumfang enthalten und nicht im Katalog verfügbar)
- Betriebstemperatur 0°C bis +70°C
- Erhältlich in 5Ø

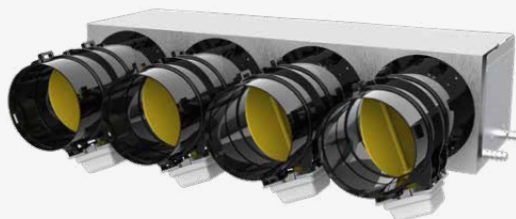

The delivery plenum for ducted unit is included in the price (please specify at the moment of order the code of plenum, see this catalog starting from pag.48)

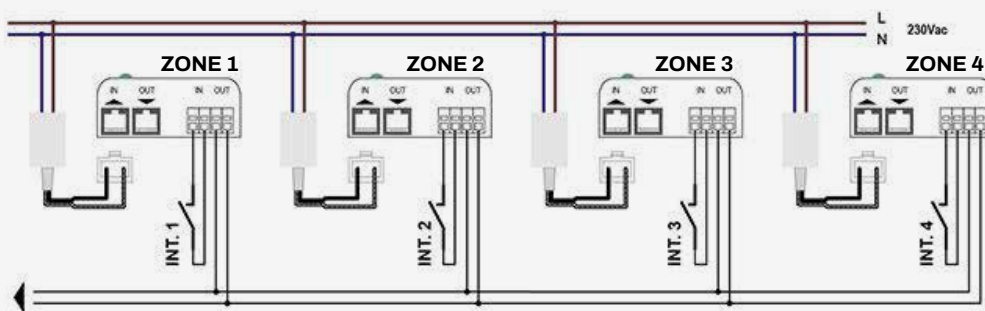

CODE	DESCRIPTION	U.M.	Pieces per box
GAD600035	"SIRIO 0.10V PACK 3 EOLO MINI"	PCS	1
GAD600036	"SIRIO 0.10V PACK 4 EOLO MINI"	PCS	1
GAD600037	"SIRIO 0.10V PACK 2 EOLO"	PCS	1
GAD600038	"SIRIO 0.10V PACK 3 EOLO"	PCS	1
GAD600039	"SIRIO 0.10V PACK 4 EOLO"	PCS	1
GAD600040	"SIRIO 0.10V PACK 5 EOLO"	PCS	1
GAD600041	"SIRIO 0.10V PACK 2 SHEET METAL Ø 150"	PCS	1
GAD600042	"SIRIO 0.10V PACK 3 SHEET METAL Ø 150"	PCS	1
GAD600043	"SIRIO 0.10V PACK 4 SHEET METAL Ø 150"	PCS	1
GAD600044	"SIRIO 0.10V PACK 5 SHEET METAL Ø 150"	PCS	1
GAD600045	"SIRIO 0.10V PACK 6 SHEET METAL Ø 150"	PCS	1
GAD600046	"SIRIO 0.10V PACK 2 SHEET METAL Ø 200"	PCS	1
GAD600047	"SIRIO 0.10V PACK 3 SHEET METAL Ø 200"	PCS	1
GAD600048	"SIRIO 0.10V PACK 4 SHEET METAL Ø 200"	PCS	1
GAD600049	"SIRIO 0.10V PACK 5 SHEET METAL Ø 200"	PCS	1
GAD600050	"SIRIO 0.10V PACK 6 SHEET METAL Ø 200"	PCS	1



ATTENTION! The Sirio 0.10V pack point systems include the dampers installed and relative testing. The chronothermostats or push-button panels are not included in the price.

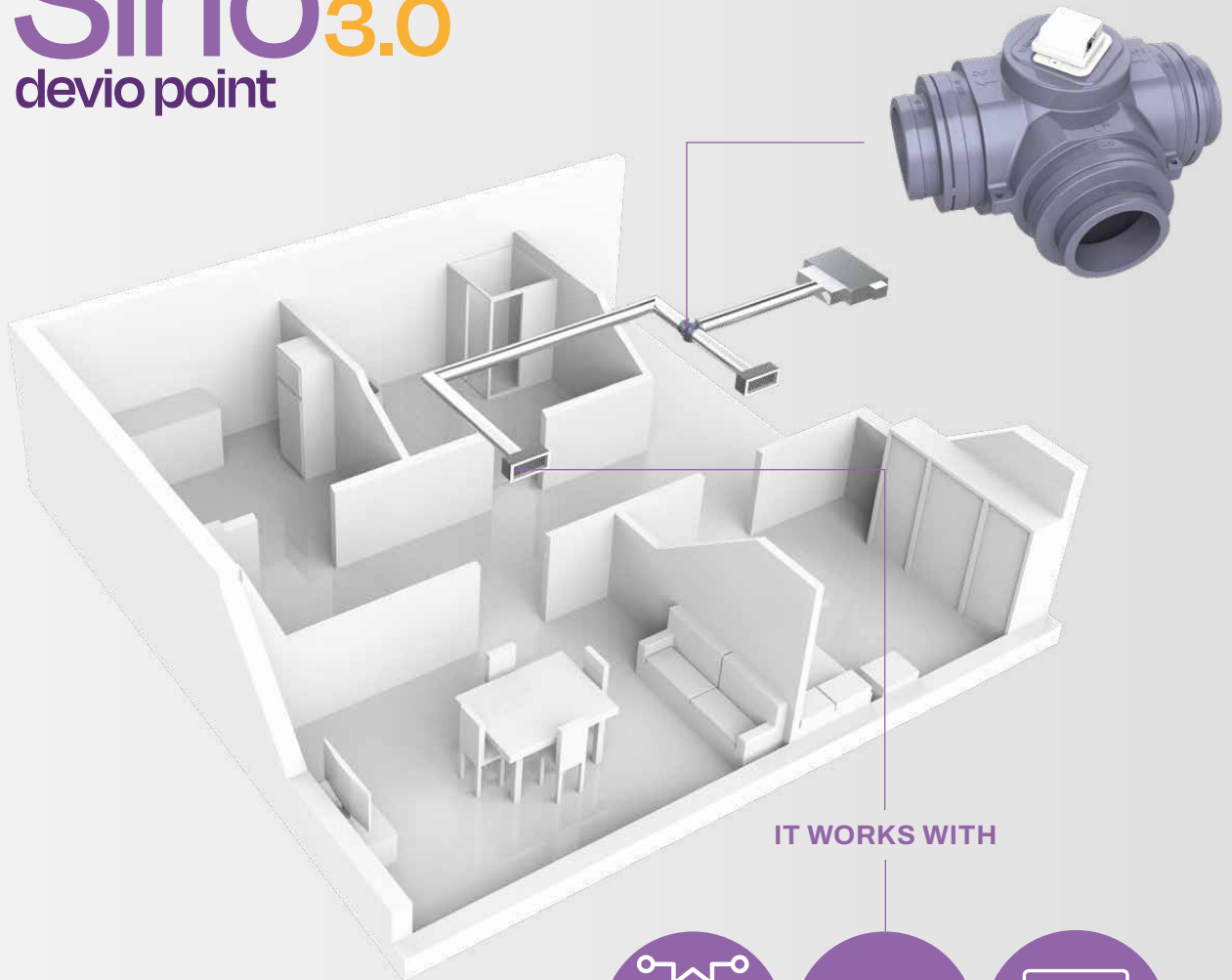

IT WORKS WITH

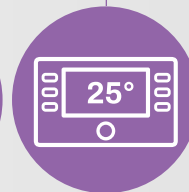
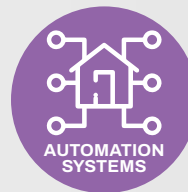

 **"T" FLOW DIVERTER WITH MOTORISED DAMPER FOR POINT SYSTEM**

The SIRIO DEVIO 3.0 Point motorised shunt allows the air flow to be diverted from one environment to another by means of a clean contact of any kind.

For example, in the residential area it is possible to divert the air flow from the living area to the sleeping area and/or vice versa due to a switch.

 **DÉVIEUR DE FLUX EN « T » AVEC REGISTRE MOTORISÉ POUR SYSTÈME PONCTUEL**

La dérivation motorisée SIRIO DEVIO 3.0 Point permet de dévier le flux d'air d'un environnement vers un autre au moyen d'un contact propre de tout type.

Par exemple, dans la zone résidentielle, il est possible de dévier le flux d'air de la zone jour vers la zone nuit et/ou vice versa grâce à un commutateur.

 **STRÖMUNGSUMLENKER "T" MIT MOTORISIERTER KLAPPE FÜR POINT SYSTEM**

Mit dem motorisierten Bypass SIRIO DEVIATION 3.0 Point kann der Luftstrom durch einen sauberen Kontakt aller Art von einer Umgebung in eine andere umgeleitet werden.

Beispielsweise ist es im Wohnbereich möglich, den Luftstrom vom Wohnbereich zum Schlafbereich und/oder umgekehrt durch einen Schalter umzuleiten.

INSTALLATION EXAMPLE



1 "T" flow diverter with motorised damper



1 on / off switch

UK "T" FLOW DIVERTER WITH
MOTORISED DAMPER

TECHNICAL SPECIFICATIONS

- Made of sintered expanded polystyrene
- Auxiliary IN/OUT contact
- Power supply 230 V (unit included)
- Potential free contact control ON/OFF
- L/R throttle movement
- Auxiliary output contact ON/OFF
- Removable, rotatable motor for easy maintenance
- Multi-diameter Ø 200/150 mm
- Suspended hook-on system

FR DÉVIATEUR DE FLUX EN « T »
AVEC REGISTRE MOTORISÉ

CARACTÉRISTIQUES TECHNIQUES

- Fabriqué en polystyrène expansé fritté
- Contact auxiliaire ENTRÉE/SORTIE
- Alimentation 230 V (bloc d'alimentation inclus)
- Commande de contact propre ON/OFF
- Mouvement de l'accélérateur G/D
- Sortie de contact utilitaire ON/OFF
- Moteur amovible et rotatif pour un entretien facile
- Diamètre multiple Ø 200/150 mm
- Système d'accouplement de suspension

DE STRÖMUNGSUMLENKER "T"
MIT MOTORISIERTER KLASPE

TECHNISCHE EIGENSCHAFTEN

- Aus gesinterter expandiertem Polystyrol
- Zusätzlicher IN/OUT-Kontakt
- Stromversorgung 230 V (Netzteil inklusive)
- Steuerung sauberer Kontakt EIN/AUS
- Drosselbewegung links/rechts
- Utility Kontaktausgang EIN/AUS
- Abnehmbarer und drehbarer Motor für einfache Wartung
- Multi-Durchmesser Ø 200/150 mm
- Hängeeinbausystem

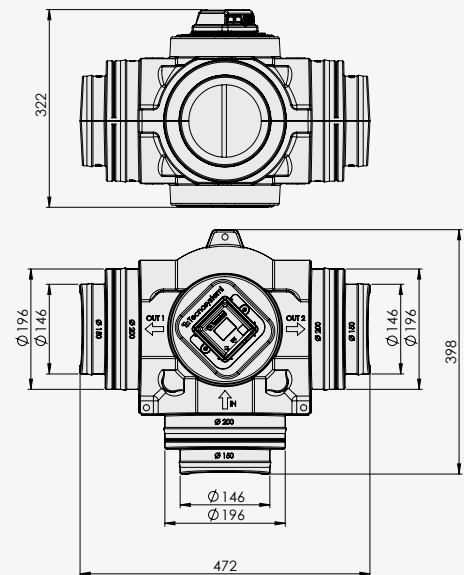

SIRIO DEVIO 3.0

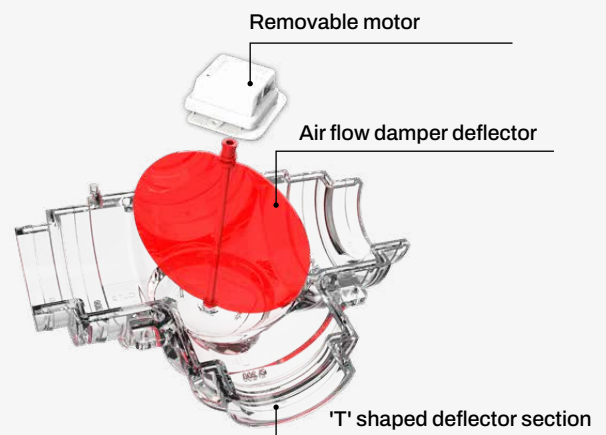
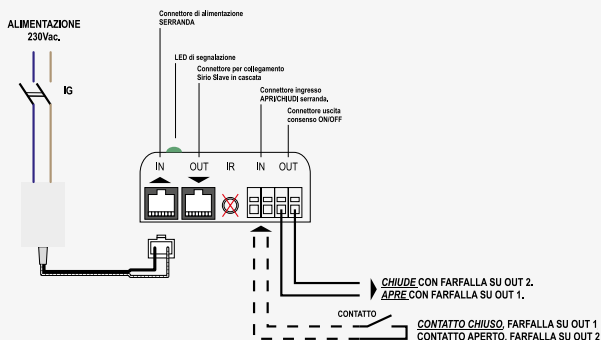

CODE	DESCRIPTION	U.M.	Pieces per box
GAD600001	SIRIO 3.0 POINT "T" SHARED AIR FLOW DEFLECTOR WITH MOTOR-DRIVEN SHUTTER	PCS	1



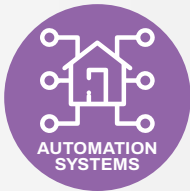
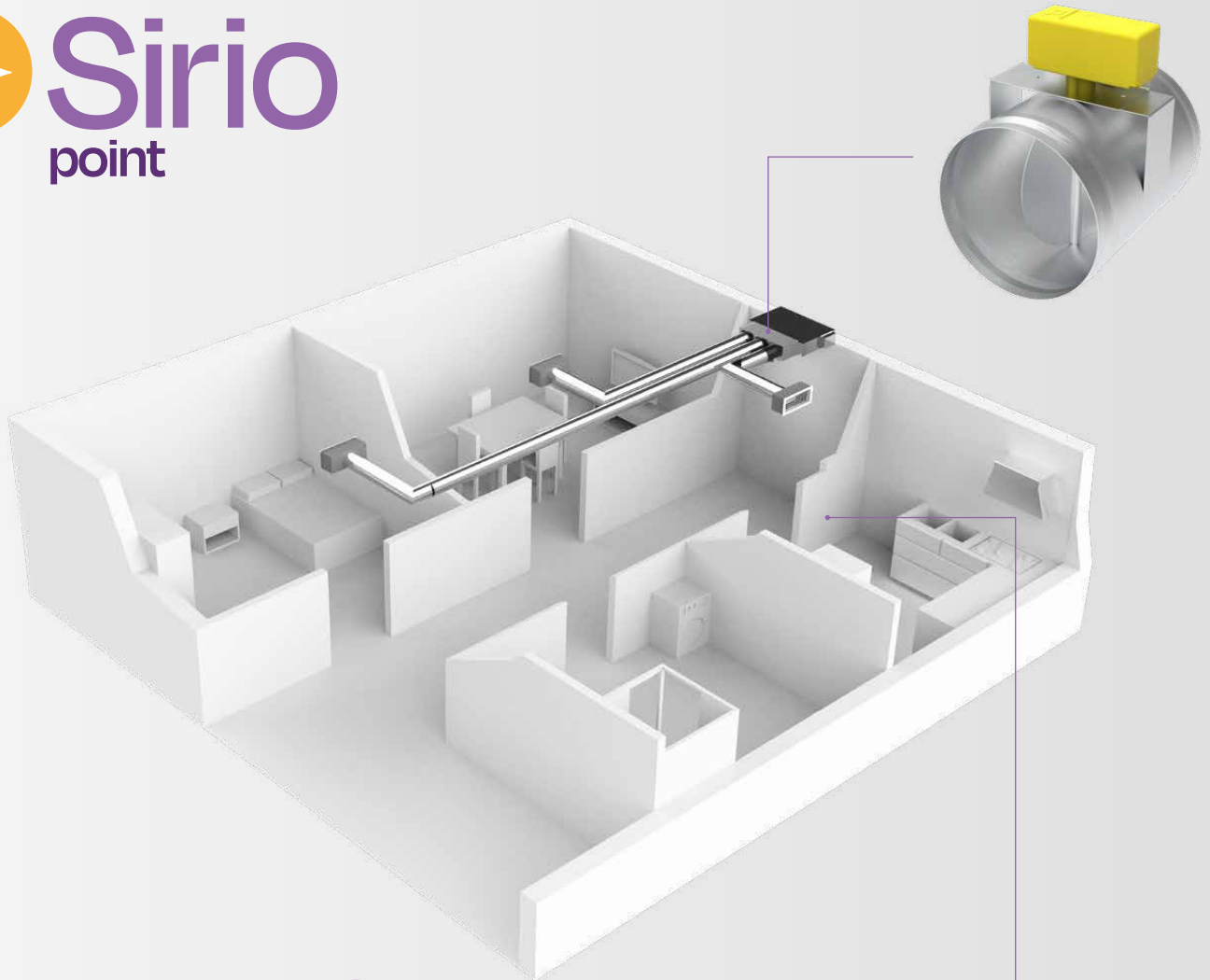

IT WORKS WITH



MOTORIZED BUTTERFLY DAMPER

The sirio butterfly dampers have an end-of-stroke micro contact, which indicates the opening and closing position of the butterfly with a clean on/off contact.

It integrates perfectly into new and existing ducted systems in which it is intended to manage only a part of the ducted system.



FERMETURE MOTORISÉE À PAPILLON

La fermeture à papillon sirio a un micro-contact de fin de course, qui indique la position d'ouverture et de fermeture du papillon avec un contact propre marche/arrêt.

Il s'intègre parfaitement dans les systèmes de goulottes neufs et existants dans lesquels il est prévu de ne gérer qu'une partie du système à goulottes.



MOTORIZIERTE KREISKLAPPE KUNSTSTOFF

Die Sirio-Klappe ist mit einem Mikrokontakt für das Hubende ausgestattet, der mit einem trockenen On/Off-Kontakt die Öffnungs- und Schließstellung der Klappe anzeigt.

Sie lässt sich perfekt in neue und bestehende Leitungssysteme integrieren, in denen nur ein Teil des Leitungssystems verwaltet werden soll.

INSTALLATION EXAMPLE



1 Sirio Point motorised butterfly damper



1 on / off switch

MOTORISED BUTTERFLY DAMPER

TECHNICAL SPECIFICATIONS

- Made from galvanised metal
- Butterfly opening from 0 to 90°
- Operating temperature 0°C to +70°C
- Includes motor (230 V power supply)
- Option of management by means of: wall/built-in regulator, with deflector, with thermostats.

AVAILABLE ON DEMAND SIRIO 2.0 POINT SYSTEM INSTALLED ON PLENUM

FERMETURE MOTORISÉE À PAPILLON

CARACTÉRISTIQUES TECHNIQUES

- Fabriqué en métal galvanisé
- Ouverture papillon de 0 à 90°
- Température de fonctionnement de 0°C à +70°C
- Livré avec moteur (alimentation 230 V)
- Possibilité de gestion par : régulateur mural / encastré, avec aiguillage, avec thermostats.

SYSTÈME SIRIO 2.0 POINT INSTALLÉ SUR PLÉNUM DISPONIBLE SUR DEMANDE

MOTORISIERTE KREISKLAPPE

TECHNISCHE EIGENSCHAFTEN

- Aus verzinktem Metall
- Von 0 bis 90° zu öffnende Klappe
- Betriebstemperatur von 0°C bis +70°C
- Komplett mit Motor (230 V Versorgung)
- Möglichkeit der Verwaltung durch: Wand-/Einbauregler, mit Umleiter, mit Thermostaten.

AUF ANFRAGE IST DAS SIRIO 2.0 POINT SYSTEM AUF DEM PLENUM INSTALLIERT VERFÜGBAR

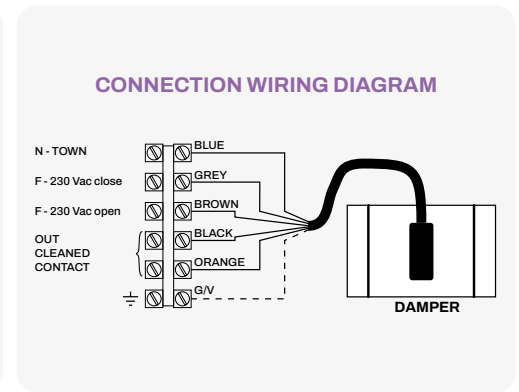
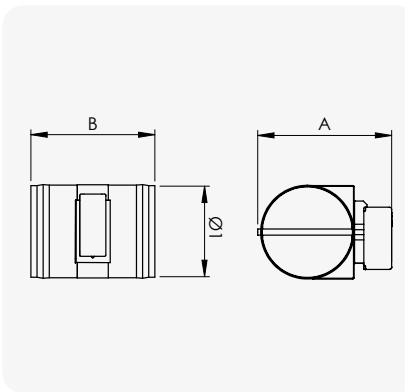
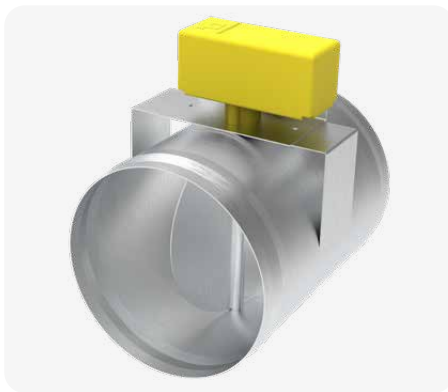

CODE	DESCRIPTION	DIMENSIONS [mm]			U.M.	Pieces per box
		A	B	Ø1		
11161854	MOTORISED BUTTERFLY DAMPER FOR "SIRIO POINT" SYSTEM- Ø120"	190	154	120	PCS	1
11161855	MOTORISED BUTTERFLY DAMPER FOR "SIRIO POINT" SYSTEM- Ø150"	220	154	150	PCS	1
11161856	MOTORISED BUTTERFLY DAMPER FOR "SIRIO POINT" SYSTEM- Ø200"	270	154	200	PCS	1
11161857	MOTORISED BUTTERFLY DAMPER FOR "SIRIO POINT" SYSTEM- Ø250"	320	154	250	PCS	1



BUILT-IN OR WALL-MOUNTED REGULATOR FOR 230 V MOTORISED BUTTERFLY DAMPER

TECHNICAL SPECIFICATIONS

- Power supply 230 V - 50/60 Hz
- Modulating controller
- LED graduated scale

RÉGULATEUR ENCASTRÉ OU MURAL POUR FERMETURE MOTORISÉE À PAPILLON 230 V

CARACTÉRISTIQUES TECHNIQUES

- Alimentation 230 V - 50/60 Hz
- Régulateur modulant
- Échelle graduée à DEL

UNTERPUTZ- ODER AUFPUTZ-SPOTREGLER FÜR MOTORISIERTE ABSPERRKLAPPE 230 V

TECHNISCHE EIGENSCHAFTEN

- Stromversorgung 230 V - 50/60 Hz
- Modulationsregler
- LED-Skala

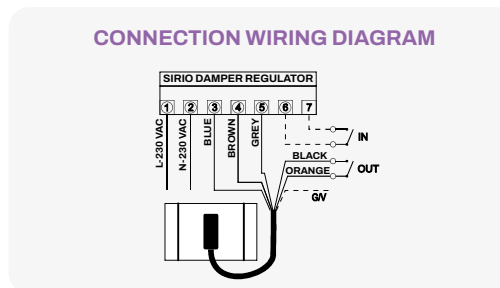

MADE IN ITALY

CODE	DESCRIPTION	U.M.	Pieces per box
11161874	BUILT-IN POINT-POINT CONTROLLER FOR ELECTRIC BUTTERFLY DAMPER 230V	PCS	1
11161875	WALL-MOUNTED POINT-POINT CONTROLLER FOR ELECTRIC BUTTERFLY DAMPER 230V	PCS	1



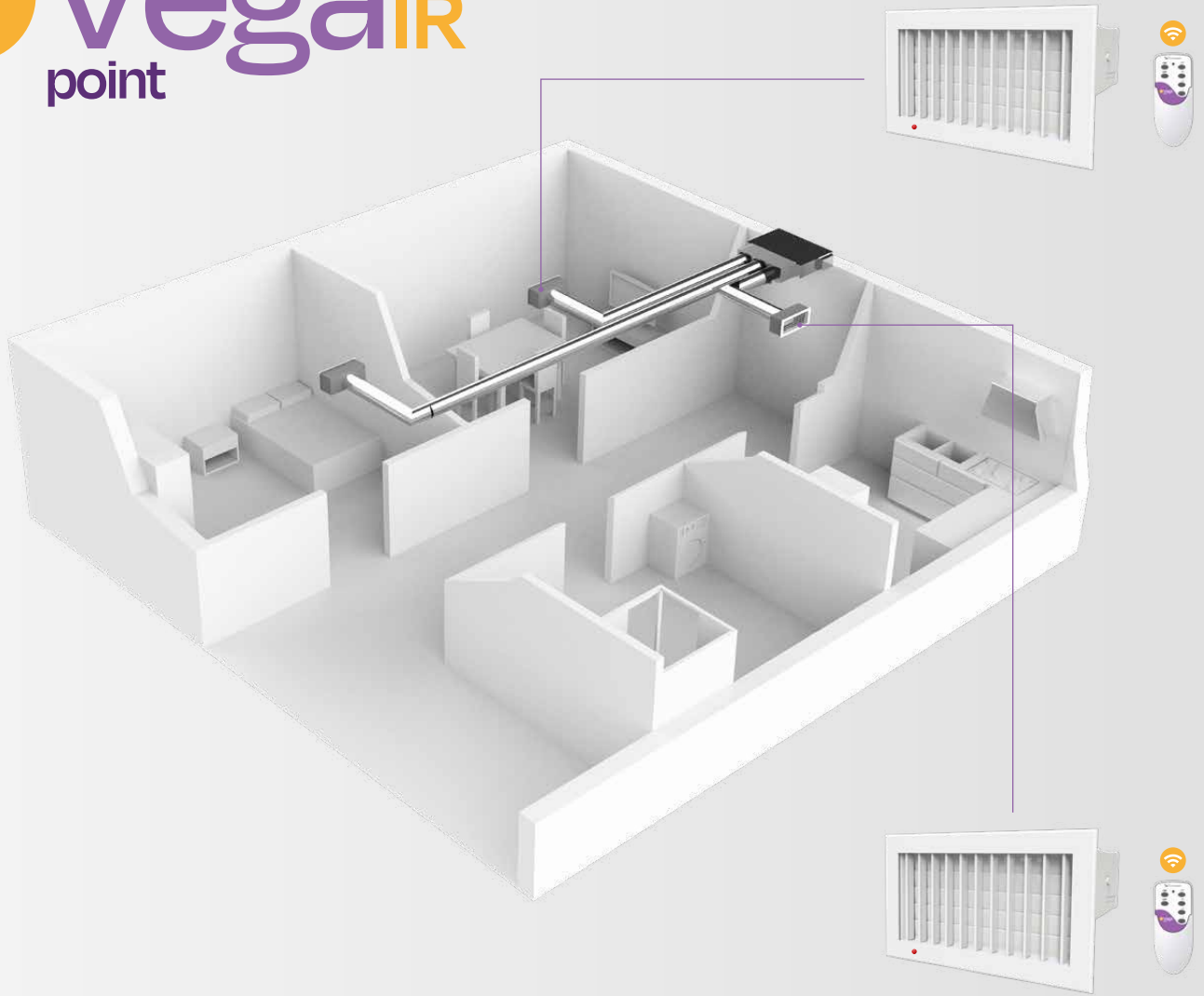

 **WHITE MOTORISED DELIVERY GRILLE WITH REMOTE CONTROL IR**

The motorised grille can be used in new and existing ducted systems. The grille is operated via the supplied ir remote control. The flaps equipped with rubber gasket guarantee tightness to the passage of air with closed grille and avoid noise.





 **GRILLE DE REFOULEMENT MOTORISÉE BLANCHE AVEC TÉLÉCOMMANDE IR**

La grille motorisée peut être utilisée dans des systèmes de goulottes neufs et existants. La grille est actionnée via la télécommande ir fournie. Les ailettes équipées de joint en caoutchouc, garantissent l'étanchéité au passage de l'air avec grille fermée et évitent le bruit.

 **WEISSE MOTORISIERTE ZULUFTÖFFNUNG MIT FERNBEDIENUNG IR**

Die motorisierte Düse kann in neuen und bestehenden Leitungssystemen eingesetzt werden. Die Bedienung der Düse erfolgt über die mitgelieferte IR-Fernbedienung, die mit gummidichtung ausgestatteten Lamellen garantieren die Dichtheit gegen den Luftdurchtritt bei geschlossener Düse und vermeiden Geräusche.

THE GRILLE CAN BE ADJUSTED INTO FOUR POSITIONS:

25% → 1/4	
50% → 2/4	
75% → 3/4	
100% → 4/4 Maximum opening	

INSTALLATION EXAMPLE

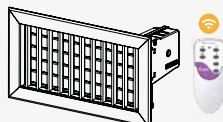
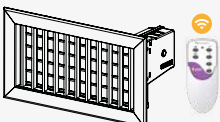

2 white Vega Point motorised delivery grille with remote control IR

WHITE MOTORISED DELIVERY GRILLE WITH REMOTE CONTROL IR

GRILLE DE REFOULEMENT MOTORISÉE BLANCHE AVEC TÉLÉCOMMANDE IR

WEISSE MOTORISIERTE ZU-LUFTGITTER MIT FERNBEDIENUNG IR

TECHNICAL SPECIFICATIONS

- White painted aluminium
- Installation via steel clips
- Remote control and power supply included ("master" version)
- "Slave" version without remote control and power supply
- Auxiliary out contact
- Power supply 230 V
- Max conveyance length 25 m
- A maximum of 8 delivery grilles can be installed in ducting

CARACTÉRISTIQUES TECHNIQUES

- Aluminium peint en blanc
- Installation via des attaches en acier
- Télécommande et alimentation inclus (version « maître »)
- Version « SLAVE » sans télécommande ni alimentation
- Contact auxiliaire sortie
- Alimentation 230 V
- Longueur maximale de la caténaire 25 m
- 8 grilles max. peuvent être installées dans la caténaire

TECHNISCHE EIGENSCHAFTEN

- Weiß lackiertes Aluminium
- Montage mit Stahlclips
- Fernsteuerung und Stromversorgung im Lieferumfang enthalten („Master“-Version)
- "Slave"-Version ohne Fernbedienung und Stromversorgung
- Hilfskontakt out
- Stromversorgung 230 V
- Max. Kettenlinienlänge 25 m
- Es können maximal 8 Luftgitter in der Kettenlinie installiert werden



AIR FLOW DIAGRAM

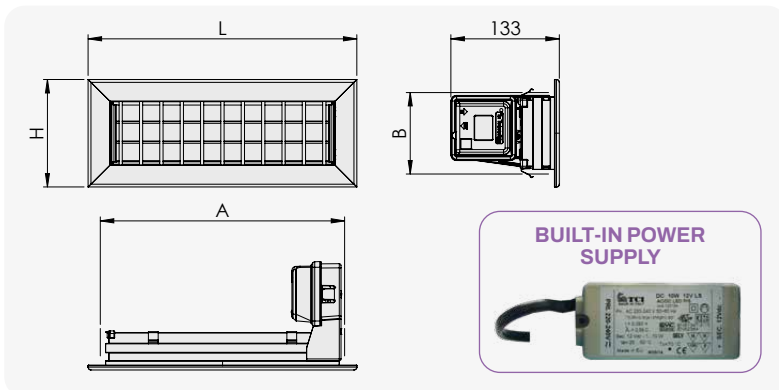
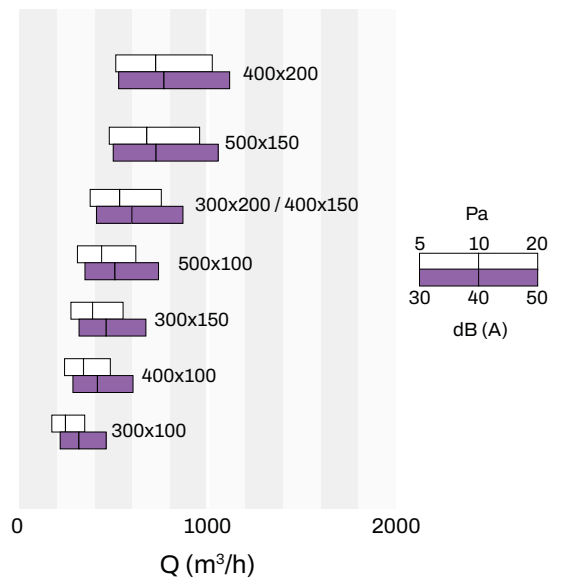

For cable connections between "master" and "slave" dampers see page 24

DIMENSIONS [mm] MASTER GRILLE						
CODE	L	H	A	B	U.M.	Pieces per box
GAD200001	332	132	300	100	PCS	1
GAD200002	332	182	300	150	PCS	1
GAD200003	332	232	300	200	PCS	1
GAD200004	432	132	400	100	PCS	1
GAD200005	432	182	400	150	PCS	1
GAD200006	432	232	400	200	PCS	1
GAD200007	532	132	500	100	PCS	1
GAD200008	532	182	500	150	PCS	1

DIMENSIONS [mm] SLAVE GRILLE						
CODE	L	H	A	B	U.M.	Pieces per box
GAD200013	332	132	300	100	PCS	1
GAD200014	332	182	300	150	PCS	1
GAD200015	332	232	300	200	PCS	1
GAD200016	432	132	400	100	PCS	1
GAD200017	432	182	400	150	PCS	1
GAD200018	432	232	400	200	PCS	1
GAD200019	532	132	500	100	PCS	1
GAD200020	532	182	500	150	PCS	1

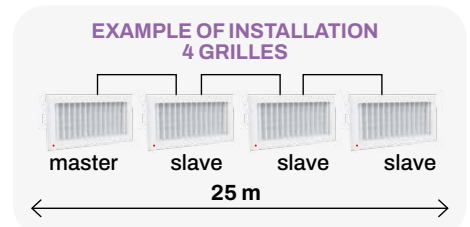
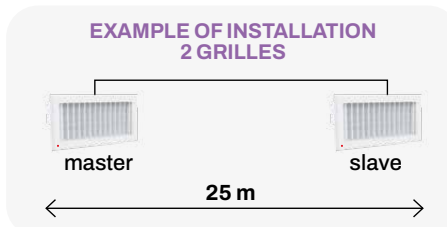
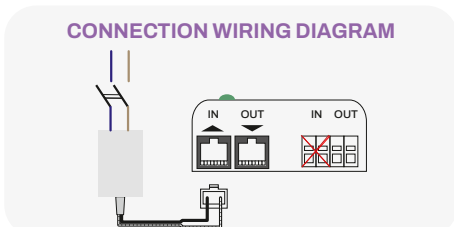

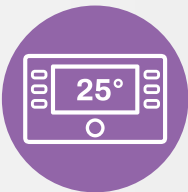
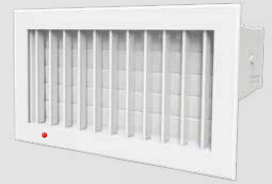
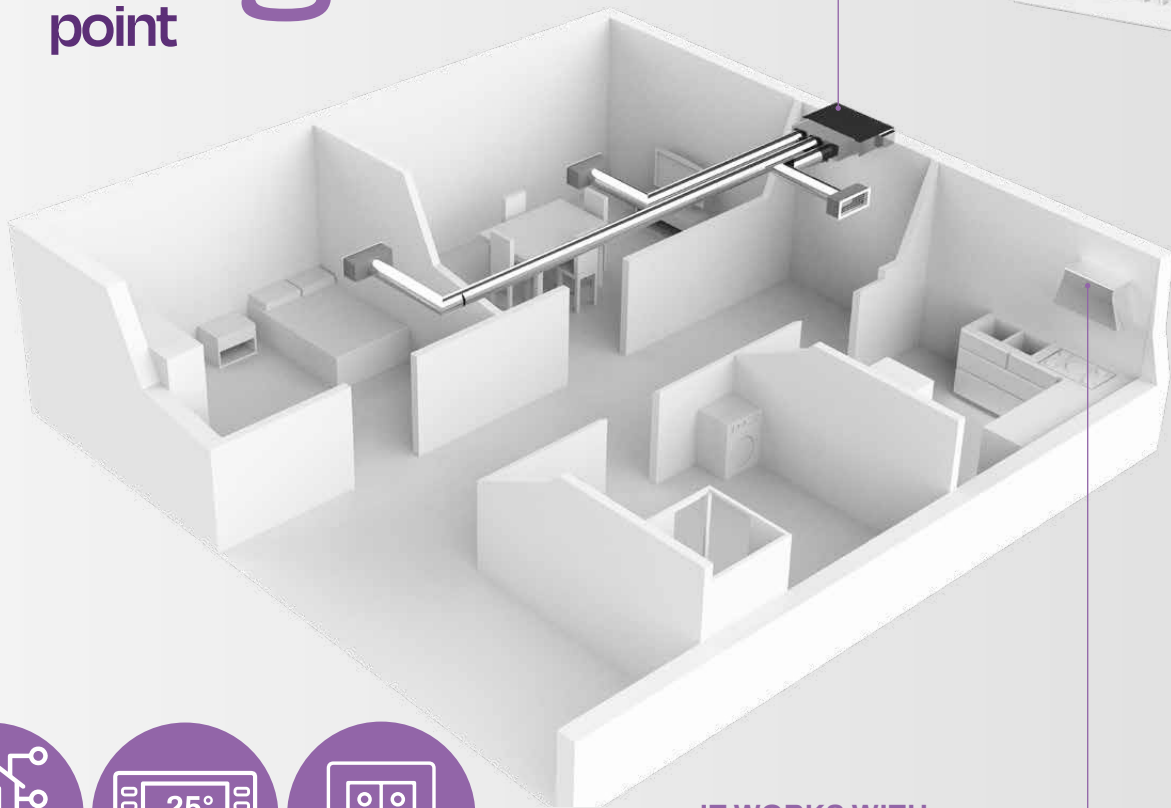

IT WORKS WITH

WHITE MOTORISED DELIVERY GRILLE

The motorized nozzle can be used in new and existing ducted systems. The operation of the grille takes place without the aid of any control unit or a particular command.

It is perfectly integrated in new and existing ducted systems in which you want to manage only a part of the ducted system: this solution does not require the installation of any system that manages the ignition / shutdown of the internal by-pass motor. Therefore it allows the management of the air flow in the individual rooms without the help of the electronic control unit for operation. The fins equipped with rubber gasket guarantee seal to air passage with the vent closed and avoid noise.

GRILLE DE REFOULEMENT MOTORISÉE BLANCHE

La grille de refolement motorisée peut être utilisée dans des systèmes de conduits nouveaux et existants. Le fonctionnement de la buse s'effectue sans l'aide d'aucune unité de commande ou une commande particulière.



Il est parfaitement intégré dans les systèmes gainables nouveaux et existants dans lesquels vous souhaitez gérer une partie unique du système gainable: cette solution ne nécessite pas l'installation d'aucun système gérant l'allumage / l'arrêt du moteur de by-pass interne. Il permet donc la gestion du flux d'air dans les pièces individuelles sans l'aide de la centrale électronique pour le fonctionnement. Les ailettes équipées de joint en caoutchouc garantissent l'étanchéité au passage de l'air avec l'évent fermé et évitent le bruit.

WEISSE MOTORISIERTE ZULUFTÖFFNUNG

Die motorisierte Düse kann in neuen und vorhandenen Kanalsystemen verwendet werden. Der Betrieb der Düse erfolgt ohne Hilfe einer Steuereinheit oder eines bestimmten Befehls.

Sie ist perfekt in neue und bestehende Kanalsysteme integriert, in denen Sie nur einen Teil des Kanalsystems verwalten möchten: Diese Lösung erfordert keine Installation eines Systems, das die Zündung/Abschaltung des internen Bypass-Motors verwaltet. Es erlaubt daher die Steuerung des Luftstroms in den einzelnen Räumen ohne Hilfe der elektronischen Steuereinheit für den Betrieb. Die mit Gummidichtungen ausgestatteten Flappen garantieren die Abdichtung des Luftdurchgangs bei geschlossener Lüftung und vermeiden Geräusche.

THE NOZZLE CAN BE ADJUSTED INTO FOUR POSITIONS:

25% → 1/4	
50% → 2/4	
75% → 3/4	
100% → 4/4 Maximum opening	

INSTALLATION EXAMPLE



Nr. 1 white Vega Point motorised delivery grille Vega Point



1 on / off switch



VIDEO

WHITE MOTORISED DELIVERY GRILLE FOR POINT SYSTEMS

GRILLE DE REFOULEMENT MOTORISÉE BLANCHE POUR SYSTÈMES PONCTUELS

MOTORISIERTER WEISSER ZU-LUFTGITTER FÜR PUNKTSYSTEME

TECHNICAL SPECIFICATIONS

- White painted aluminium
- Installation via steel clips
- Remote control and power supply included ("master" version)
- "Slave" version without remote control and power supply
- Auxiliary out contact
- Power supply 230 V
- Max conveyance length 25 m
- A maximum of 8 delivery grilles can be installed in ducting

CARACTÉRISTIQUES TECHNIQUES

- Aluminium peint en blanc
- Installation via des attaches en acier
- Télécommande et alimentation inclus (version « maître »)
- Version « SLAVE » sans télécommande ni alimentation
- Contact auxiliaire sortie
- Alimentation 230 V
- Longueur maximale de la caténaire 25 m
- 8 grilles max. peuvent être installées dans la caténaire

TECHNISCHE EIGENSCHAFTEN

- Weiß lackiertes Aluminium
- Montage mit Stahlclips
- Fernsteuerung und Stromversorgung im Lieferumfang enthalten („Master“-Version)
- "Slave"-Version ohne Fernbedienung und Stromversorgung
- Hilfskontakt out
- Stromversorgung 230 V
- Max. Kettenlinienlänge 25 m
- Es können maximal 8 Luftgitter in der Kettenlinie installiert werden



AIR FLOW DIAGRAM

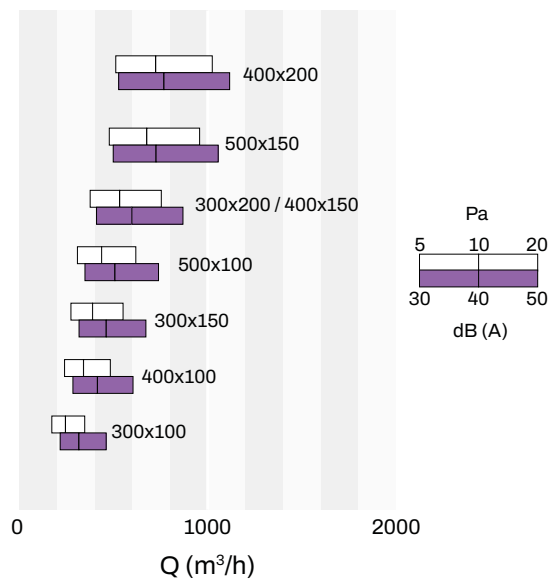

For cable connections between "master" and "slave" dampers see page 24

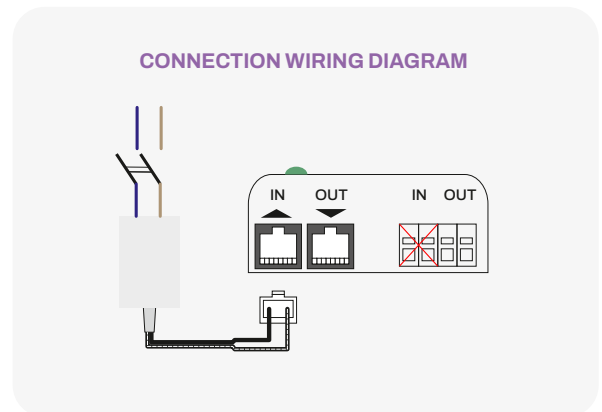
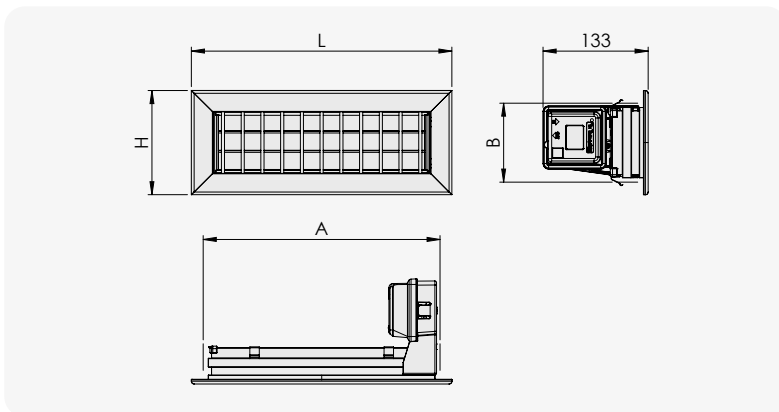

DIMENSIONS [mm]						
CODE	L	H	A	B	U.M.	Pieces per box
GAD200028	332	132	300	100	PCS	1
GAD200027	332	182	300	150	PCS	1
GAD200029	332	232	300	200	PCS	1
GAD200030	432	132	400	100	PCS	1
GAD200031	432	182	400	150	PCS	1
GAD200032	432	232	400	200	PCS	1
GAD200033	532	132	500	100	PCS	1
GAD200034	532	182	500	150	PCS	1



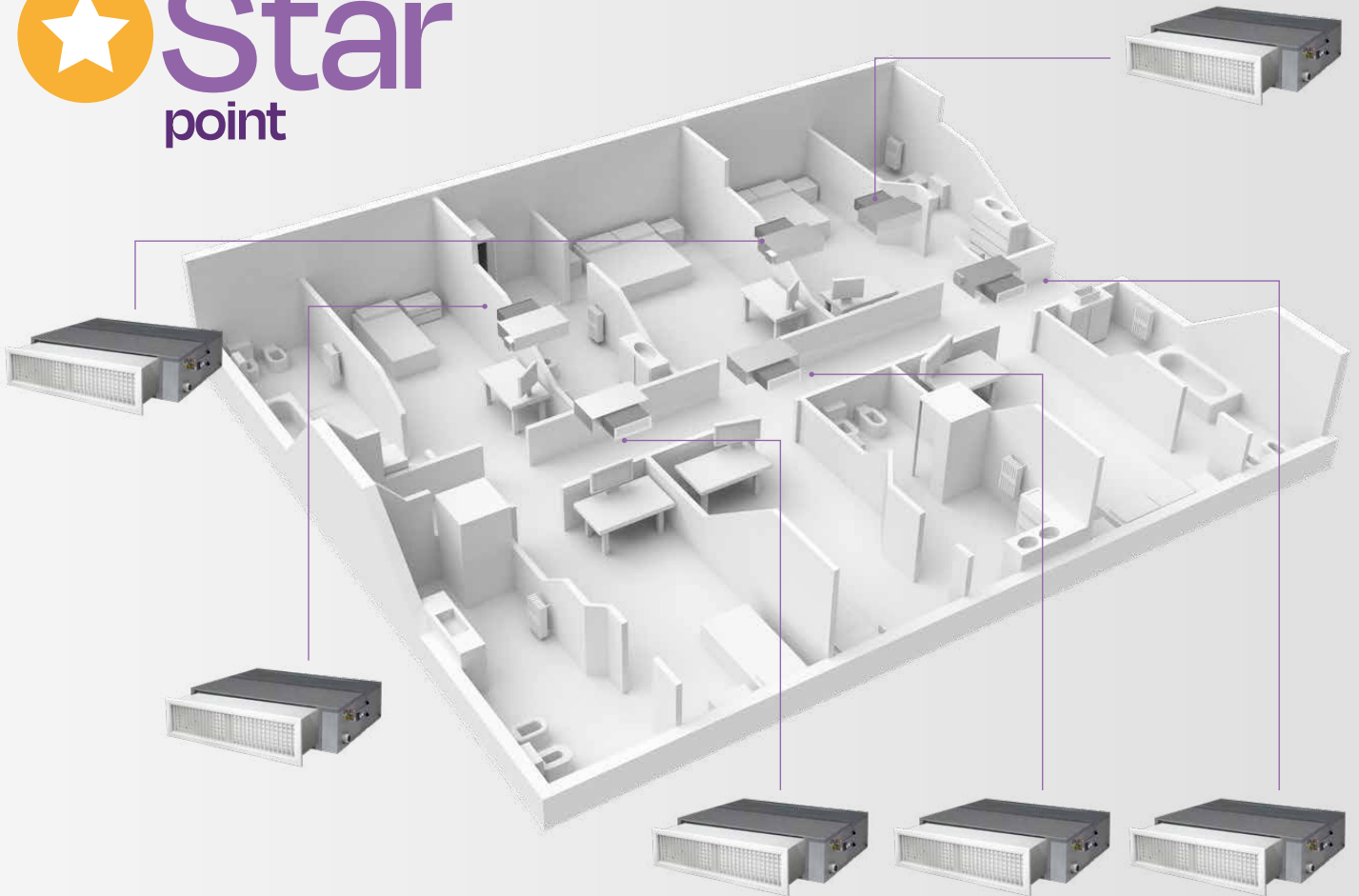

WHITE PAINTED MOTORISED DELIVERY NOZZLE WITH OR WITHOUT TELESCOPIC PLENUM FOR LOW-PREVALENCE DUCTED UNITS

The **STAR delivery nozzle** is designed to meet the functional and aesthetic needs in the installations of low-prevalence indoor units. The star delivery nozzle opens when the machine is switched on and closes when it is switched off, without having to make electrical connections between the machine and the nozzle itself. Ideal for hotels, restaurants, etc.



GRILLE DE REFOULEMENT MOTORISÉE PEINTE EN BLANCHE AVEC OU SANS PLÉNUM TÉLESCOPIQUE POUR UNITÉ CANALISÉE À FAIBLE PRÉVALENCE

La **grille de distribution STAR** est conçue pour répondre aux besoins fonctionnels et esthétiques dans les installations d'unités intérieures à faible prévalence. La grille de distribution star s'ouvre lorsque la machine est allumée et se ferme lorsqu'elle est éteinte, sans avoir à établir de connexions électriques entre la machine et la grille. idéal pour les hôtels, les restaurants, etc.



WEISS LACKIERTE MOTORISIERTE ZULUFTÖFFNUNG MIT ODER OHNE TELESKOPISEM PLENUM FÜR DAS LEITUNGSSYSTEM

Die **STAR-Abgabedüse** ist so konzipiert, dass sie die funktionalen und ästhetischen Anforderungen bei der Installation von Inneneinheiten mit niedriger Förderhöhe erfüllt. Die Star-Abgabedüse öffnet bei eingeschalteter Maschine und schließt bei ausgeschalteter Maschine, ohne elektrische Verbindungen zwischen der Maschine und der Düse selbst herstellen zu müssen. Ideal für, Hotels, Restaurants, usw.

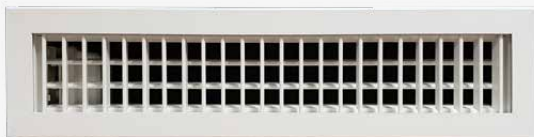

When on working the grille stays opened



The grille closes when the unit turns off



From now on **no more open flaps** on your air conditioning unit.



"Star point" will make your air conditioning system more attractive. Now the **star point system** automatically closes the outlet when the unit is turned off.



Open automatically when you turn the air conditioning unit on

MOTORISED DELIVERY GRILLE COMPLETE WITH TELESCOPIC PLENUM FOR LOW-PREVALENCE DUCTED UNITS

TECHNICAL SPECIFICATIONS

- White painted aluminium
- Automatic opening in presence of air flow, automatic closure in absence of air flow
- Equipment: plenum for connection to low hydraulic head ducted units
- Power supply 230 V
- Built-in power supply included

GRILLE DE REFOULEMENT MOTORISÉE AVEC PLÉNUM TÉLESCOPIQUE POUR UNITÉ CANALISÉE À FAIBLE PRÉVALENCE

CARACTÉRISTIQUES TECHNIQUES

- Aluminium peint en blanc
- Ouverture automatique en présence de débit d'air, fermeture automatique en l'absence de débit d'air
- Équipement : plénum pour le raccordement aux unités à conduits à faible prévalence
- Alimentation 230 V
- Bloc d'alimentation intégré inclus

MOTORISIERTER ZULUFTGITTER MIT TELESKOPISCHEM PLENUM FÜR DAS LEITUNGSSYSTEM MIT NIEDRIGER FÖRDERHÖHE

TECHNISCHE EIGENSCHAFTEN

- Weiß lackiertes Aluminium
- Automatisches Öffnen bei Vorhandensein eines Luftstroms, automatisches Schließen bei Nichtvorhandensein eines Luftstroms
- Ausstattung: Plenum zum Anschluss an kanalisierte Einheit mit niedriger Förderhöhe
- Stromversorgung 230 V
- Integriertes Netzteil im Lieferumfang enthalten

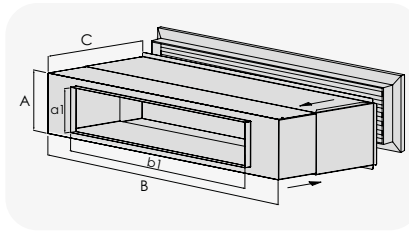

When placing the order: provide the supply air grille dimensions of the unit (A1 x B1 mm).

CODE	ELECTRIC SUPPLY GRILLE		TELESCOPIC PLENUM						
	EXTERNAL FRAME	HOLE INSTALLATION SIZE	HEIGHT PLENUM	WIDTH PLENUM	DEPTH MIN-MAX	HEIGHT OF WINDOW CONNECTION UNITS	WIDTH OF THE WINDOW CONNECTION UNITS	U.M.	Pieces per box
	[mm]	[mm]	A [mm]	B [mm]	C [mm]	A1 [mm]	B1 [mm]		
GAD200021	732 x 182	700 x 150	140	690	285-430	REQUEST MAX 135	REQUEST MAX 685	PCS	1
GAD200022	932 x 182	900 x 150	140	890	285-430	REQUEST MAX 135	REQUEST MAX 885	PCS	1
GAD200023	932 x 232	900 x 200	190	890	285-430	REQUEST MAX 185	REQUEST MAX 885	PCS	1

WHITE PAINTED MOTORISED DELIVERY GRILLE FOR LOW-PREVALENCE DUCTED UNITS

TECHNICAL SPECIFICATIONS

- White painted aluminium
- Automatic opening in presence of air flow, automatic closure in absence of air flow
- Power supply 220 V
- Built-in power supply included

GRILLE DE REFOULEMENT MOTORISÉE PEINTE EN BLANC POUR UNITÉ CANALISÉE À FAIBLE PRÉVALENCE

CARACTÉRISTIQUES TECHNIQUES

- Aluminium peint en blanc
- Ouverture automatique en présence de débit d'air, fermeture automatique en l'absence de débit d'air
- Alimentation 220 V
- Bloc d'alimentation intégré inclus

WEISS LACKIERTE MOTORISIERTER ZULUFTGITTER FÜR KANALISIERTE EINHEIT MIT NIEDRIGER FÖRDERHÖHE

TECHNISCHE EIGENSCHAFTEN

- Weiß lackiertes Aluminium
- Automatisches Öffnen bei Vorhandensein eines Luftstroms, automatisches Schließen bei Nichtvorhandensein eines Luftstroms
- Stromversorgung 220 V
- Integriertes Netzteil im Lieferumfang enthalten



Recessed box for three modules not included.

CODE	DESCRIPTION	ELECTRIC SUPPLY GRILLE			
		EXTERNAL FRAME [mm]	HOLE INSTALLATION SIZE [mm]	U.M.	Pieces per box
GAD200024	STAR POINT 700X150 -WHITE PAINTED (RAL 9010) ELECTRIC SUPPLY GRILLE FOR LOW HYDRAULIC HEAD DUCTED UNITS	732x182	700x150	PCS	1
GAD200025	STAR POINT 900X150 -WHITE PAINTED (RAL 9010) ELECTRIC SUPPLY GRILLE FOR LOW HYDRAULIC HEAD DUCTED UNITS	932x182	900x150	PCS	1
GAD200026	STAR POINT 700X200 -WHITE PAINTED (RAL 9010) ELECTRIC SUPPLY GRILLE FOR LOW HYDRAULIC HEAD DUCTED UNITS	932x232	900x200	PCS	1





Galaxy

Multi-zone Air Control System

INDEX CATALOGUE 39

CODE	PAGE	CODE	PAGE	CODE	PAGE	CODE	PAGE	CODE	PAGE
11132600	25	11181720	24	GAD200016	87	GAD400376	45	GAD400507	35
11161295	26	11181730	24	GAD200017	87	GAD400377	45	GAD400508	35
11161296	26	11181740	24	GAD200018	87	GAD400378	46	GAD400511	36
11161297	26	11181750	24	GAD200019	87	GAD400379	32	GAD400512	36
11161298	26	11181760	24	GAD200020	87	GAD400380	32	GAD400515	37
11161854	85	11181764	25	GAD200024	91	GAD400381	34	GAD400517	38
11161855	85	11181770	25	GAD200025	91	GAD400382	34	GAD400518	38
11161856	85	C20000808	20	GAD200026	91	GAD400383	36	GAD400521	39
11161857	85	C20000809	20	GAD200027	89	GAD400384	36	GAD400523	40
11161874	85	GAC500001	58	GAD200028	89	GAD400391	38	GAD400524	40
11161875	85	GAC500002	58	GAD200029	89	GAD400392	38	GAD500001	67
11171722	59	GAC500003	59	GAD200030	89	GAD400395	40	GAD500002	67
11171723	60	GAC500004	64	GAD200031	89	GAD400396	40	GAD500003	68
11171724	60	GAC500005	65	GAD200032	89	GAD400399	43	GAD500004	68
11171725	61	GAC500006	65	GAD200033	89	GAD400400	43	GAD500005	69
11171726	61	GAC500007	66	GAD200034	89	GAD400401	44	GAD600001	83
11171732	62	GAC500008	66	GAD300001	75	GAD400402	44	GAD600003	79
11171733	62	GAC500014	51	GAD300002	75	GAD400403	45	GAD600004	79
11171734	63	GAC500015	51	GAD300003	75	GAD400404	45	GAD600005	79
11171735	63	GAC500016	52	GAD300004	75	GAD400405	46	GAD600006	79
11171736	64	GAC500017	52	GAD300005	75	GAD400406	46	GAD600007	79
11181407	22	GAC500018	53	GAD300007	75	GAD400407	47	GAD600008	79
11181454	71	GAC500019	53	GAD300008	75	GAD400408	47	GAD600009	79
11181530	20	GAC500020	54	GAD300009	75	GAD400409	31	GAD600010	79
11181540	20	GAC500021	54	GAD300010	75	GAD400410	33	GAD600011	79
11181551	72	GAC500022	55	GAD300011	75	GAD400411	33	GAD600012	79
11181556	72	GAC500023	55	GAD300014	77	GAD400412	35	GAD600013	79
11181561	72	GAC500024	56	GAD300015	77	GAD400413	35	GAD600014	79
11181566	72	GAC500025	56	GAD300016	77	GAD400414	37	GAD600015	79
11181571	72	GAC500026	57	GAD300017	77	GAD400415	39	GAD600016	79
11181610	21	GAD100005	14	GAD300018	77	GAD400416	32	GAD600017	79
11181620	21	GAD100011	17	GAD300019	19	GAD400417	32	GAD600018	79
11181630	21	GAD100012	10	GAD300020	19	GAD400418	34	GAD600019	79
11181640	21	GAD100014	22	GAD300021	19	GAD400419	34	GAD600020	79
11181650	21	GAD100015	18	GAD300022	19	GAD400420	36	GAD600021	79
11181660	21	GAD100016	15	GAD400201	26	GAD400421	36	GAD600022	79
11181670	21	GAD200001	87	GAD400254	23	GAD400422	38	GAD600023	79
11181680	21	GAD200002	87	GAD400359	31	GAD400423	38	GAD600024	79
11181683	73	GAD200003	87	GAD400361	33	GAD400424	40	GAD600025	79
11181685	73	GAD200004	87	GAD400362	33	GAD400425	40	GAD600026	79
11181687	73	GAD200005	87	GAD400365	35	GAD400493	31	GAD600027	79
11181689	73	GAD200006	87	GAD400366	35	GAD400495	32	GAD600028	79
11181691	73	GAD200007	87	GAD400369	37	GAD400496	32	GAD600029	79
11181693	73	GAD200008	87	GAD400371	39	GAD400499	33	GAD600030	79
11181695	73	GAD200013	87	GAD400373	43	GAD400500	33	GAD600031	79
11181697	73	GAD200014	87	GAD400374	44	GAD400503	34	GAD600032	79
11181710	24	GAD200015	87	GAD400375	44	GAD400504	34	GAD600033	79

CODE	PAGE
GAD600034	79
GAD600035	81
GAD600036	81
GAD600037	81
GAD600038	81
GAD600039	81
GAD600040	81
GAD600041	81
GAD600042	81
GAD600043	81
GAD600044	81
GAD600045	81
GAD600046	81
GAD600047	81
GAD600048	81
GAD600049	81
GAD600050	81

New Products