

DATASHEET

rev. 00 - 18/10/2022



Mixed flow in-line fan

30360150 - 30360160 - 30360170
30360250 - 30360260

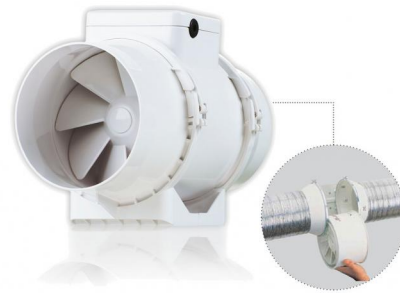

TECHNICAL SPECIFICATIONS:

- Made of ABS
- Easy to install and inspect
- 2 speeds
- Operable via ON / OFF switch (not supplied)
- Recommended for kitchens, bathrooms, offices, shops

FLOW RATE DIAGRAMS

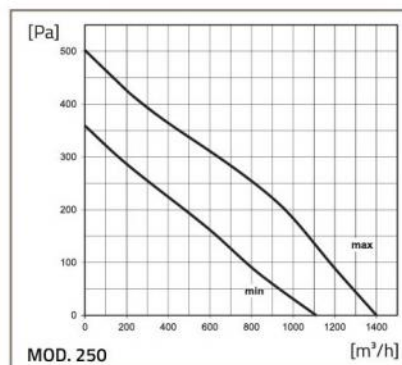
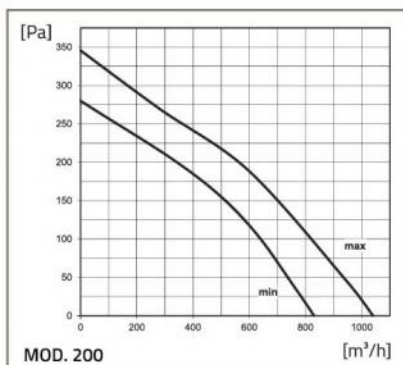
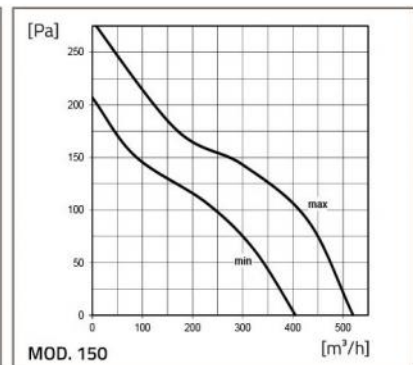
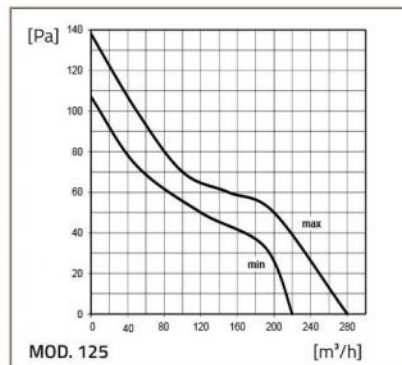
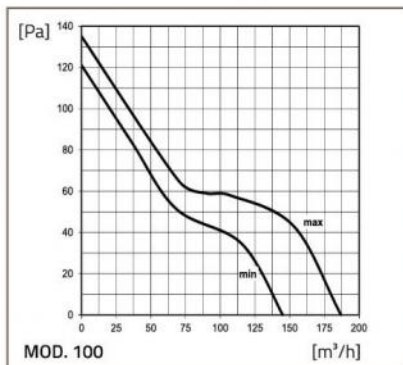

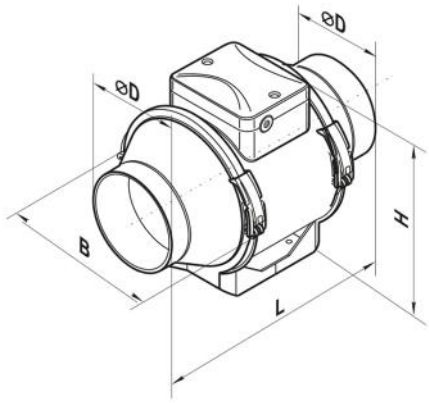

DIMENSIONS

CODE	Ø D [mm]	B [mm]	H [mm]	L [mm]	WEIGHT [kg]
30360150	96	167	190	246	1,4
30360160	123	167	190	246	1,8
30360170	146	223	250	295	3,2
30360250	199	239	261	295,5	4
30360260	247	287	323	383	7,8

TECHNICAL DATA

MODEL	Ø 100		Ø 125		Ø 150		Ø 200		Ø 250	
Power supply [V]	230	230	230	230	230	230	230	230	230	230
Frequency [Hz]	50	50	50	50	50	50	50	50	50	50
Speed	min.	max.	min.	max.	min.	max.	min.	max.	min.	max.
Power [W]	21	33	23	37	30	60	76	108	125	177
Absorbed current [A]	0,11	0,21	0,18	0,27	0,17	0,27	0,34	0,48	0,54	0,79
Air flow rate [m ³ /h]	145	187	220	280	405	520	830	1040	1110	1400
RPM	2180	2385	1950	2455	1680	2460	1915	2380	1955	2440
Sound level 3 m [dB(A)]	27	36	28	37	33	44	45	52	47	55
Operating temperature max [°C]	60	60	60	60	60	60	60	60	60	60
Protection rating [IP]	X4									X4

ITEMS

CODE	DESCRIPTION
30360150	MIXED-FLOW FANS - "IN LINEA" MODEL 100
30360160	MIXED-FLOW FANS - "IN LINEA" MODEL 125
30360170	MIXED-FLOW FANS - "IN LINEA" MODEL 150
30360250	MIXED-FLOW FANS - "IN LINEA" MODEL 200
30360260	MIXED-FLOW FANS - "IN LINEA" MODEL 250