

DATASHEET

rev. 00 - 00-00-0000

HSCL 100/20-65

support for fixing on tiled roofs

11110712Z - 11110712ZBOX

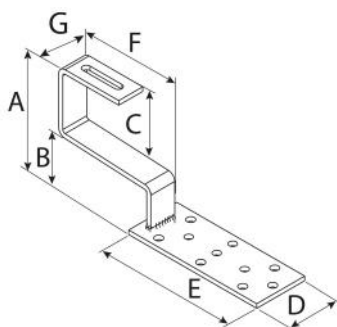

DIMENSIONS

CODE	A [mm]	B [mm]	C [mm]	D [mm]	E [mm]	F [mm]	G [mm]
11110712Z	100	20	65	60	160	110	30
11110712ZBOX X	100	20	65	60	160	110	30

ITEMS

CODE	DESCRIPTION
11110712Z	SUPPORT FOR FIXING ON ROOFS CON COPPI HSCL 100/20-65 ZINCATO
11110712ZBOX X	SUPPORT FOR FIXING ON ROOFS CON COPPI HSCL 100/20-65 GALVANIZED- BOX 10 pcs